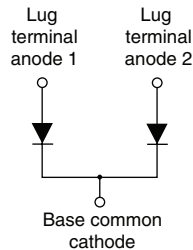

FRED Pt™ Ultrafast Soft Recovery Diode, 360 A

TO-244

FEATURES

- Very low Q_{rr} and t_{rr}
- Lead (Pb)-free
- Designed and qualified for industrial level

**RoHS
COMPLIANT**
BENEFITS

- Reduced RFI and EMI
- Higher frequency operation
- Reduced snubbing

DESCRIPTION

FRED Pt™ diodes are optimized to reduce losses and EMI/RFI in high frequency power conditioning systems. The softness of the recovery eliminates the need for a snubber in most applications. These devices are ideally suited for HF welding, power converters and other applications where switching losses are a significant portion of the total losses.

PRODUCT SUMMARY

$I_{F(AV)}$	360 A
V_R	400 V
Q_{rr} (typical)	1250 nC
t_{rr}	40 ns

ABSOLUTE MAXIMUM RATINGS

PARAMETER	SYMBOL	TEST CONDITIONS	MAX.	UNITS
Cathode to anode voltage	V_R		400	V
Continuous forward current per diode	$I_{F(AV)}$	$T_C = 25\text{ °C}$	510	A
		$T_C = 85\text{ °C}$	305	
		$T_C = 116\text{ °C}$	180	
Single pulse forward current per diode	I_{FSM}		1200	
Maximum power dissipation	P_D	$T_C = 25\text{ °C}$	570	W
		$T_C = 110\text{ °C}$	180	
Operating junction and storage temperatures	T_J, T_{Stg}		- 40 to 150	°C

ELECTRICAL SPECIFICATIONS PER LEG ($T_J = 25\text{ °C}$ unless otherwise specified)

PARAMETER	SYMBOL	TEST CONDITIONS	MIN.	TYP.	MAX.	UNITS
Breakdown voltage	V_{BR}	$I_R = 100\text{ }\mu\text{A}$	400	-	-	V
Forward voltage	V_{FM}	$I_F = 180\text{ A}$	-	1.09	1.27	
		$I_F = 360\text{ A}$	-	1.23	1.50	
		$I_F = 180\text{ A}, T_J = 175\text{ °C}$	-	0.88	0.96	
		$I_F = 360\text{ A}, T_J = 175\text{ °C}$	-	1.04	1.18	
Reverse leakage current	I_{RM}	$T_J = 150\text{ °C}, V_R = V_R$ rated	-	0.26	1.28	mA
Series inductance	L_S	From top of terminal hole to mounting plane	-	5	-	nH

DYNAMIC RECOVERY CHARACTERISTICS ($T_J = 25\text{ }^\circ\text{C}$ unless otherwise specified)						
PARAMETER	SYMBOL	TEST CONDITIONS	MIN.	TYP.	MAX.	UNITS
Reverse recovery time	t_{rr}	$I_F = 1.0\text{ A}$, $di_F/dt = 200\text{ A}/\mu\text{s}$, $V_R = 30\text{ V}$	-	40	69	ns
		$T_J = 25\text{ }^\circ\text{C}$	-	74	-	
		$T_J = 150\text{ }^\circ\text{C}$		171	-	
Peak recovery current	I_{RRM}	$I_F = 1.0\text{ A}$, $di_F/dt = 200\text{ A}/\mu\text{s}$, $V_R = 30\text{ V}$	-	5.1	-	A
		$I_F = 180\text{ A}$, $di_F/dt = 200\text{ A}/\mu\text{s}$, $V_R = 200\text{ V}$	-	6.6	-	
		$I_F = 180\text{ A}$, $di_F/dt = 200\text{ A}/\mu\text{s}$, $V_R = 200\text{ V}$, $T_J = 150\text{ }^\circ\text{C}$	-	15.2	-	
Reverse recovery charge	Q_{rr}	$I_F = 1.0\text{ A}$, $di_F/dt = 200\text{ A}/\mu\text{s}$, $V_R = 30\text{ V}$	-	125	-	nC
		$I_F = 180\text{ A}$, $di_F/dt = 200\text{ A}/\mu\text{s}$, $V_R = 200\text{ V}$	-	243	-	
		$I_F = 180\text{ A}$, $di_F/dt = 200\text{ A}/\mu\text{s}$, $V_R = 200\text{ V}$, $T_J = 150\text{ }^\circ\text{C}$	-	1295	-	

THERMAL - MECHANICAL SPECIFICATIONS						
PARAMETER	SYMBOL	MIN.	TYP.	MAX.	UNITS	
Thermal resistance, junction to case	R_{thJC}	-	-	0.19	$^\circ\text{C}/\text{W}$	
		-	-	0.095		
Thermal resistance, case to heatsink (flag greased surface)	R_{thCS}	-	0.10	-		
Weight		-	68	-	g	
		-	2.4	-	oz.	
Mounting torque		30 (3.4)	-	40 (4.6)	lbf · in (N · m)	
Mounting torque center hole		12 (1.4)	-	18 (2.1)		
Terminal torque		30 (3.4)	-	40 (4.6)		
Vertical pull		-	-	80	lbf · in	
2" lever pull		-	-	35		



FRED Pt™
Ultrafast Soft Recovery Diode,
360 A

Vishay High Power Products

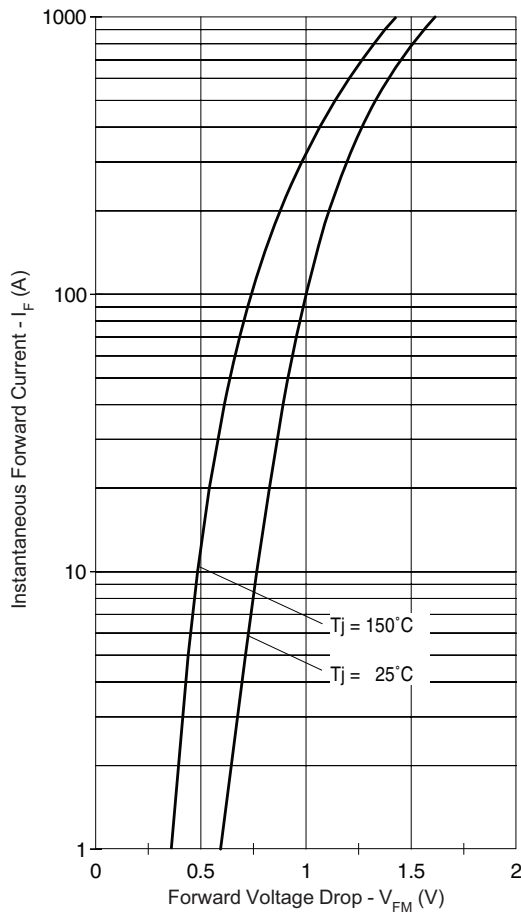

Fig. 1 - Typical Forward Voltage Drop vs. Instantaneous Forward Current (Per Leg)

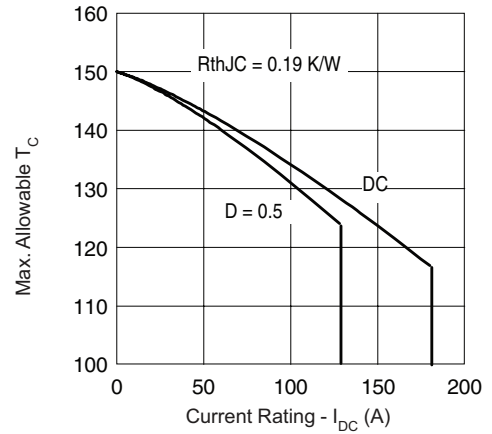

Fig. 3 - Maximum Current Rating Capability (Per Leg)

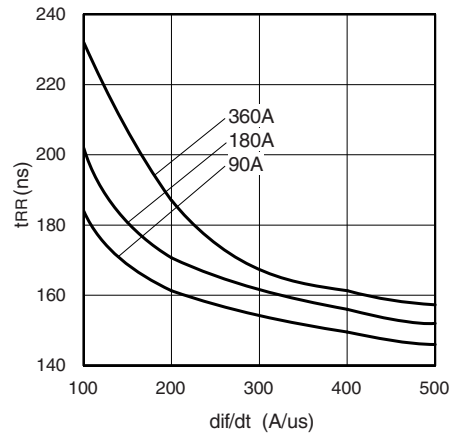

Fig. 4 - Typical Reverse Recovery Time vs. di_F/dt $T_J = 125^\circ\text{C}$ (Per Leg)

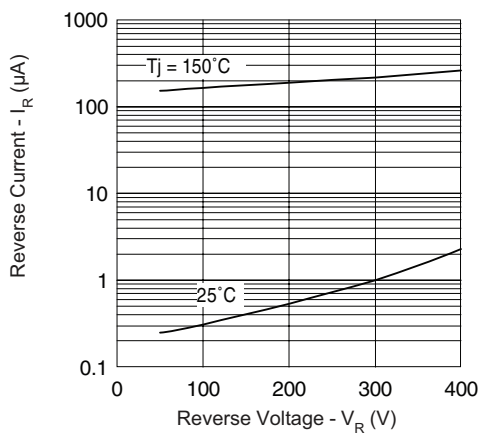

Fig. 2 - Typical Reverse Current vs. Reverse Voltage (Per Leg)

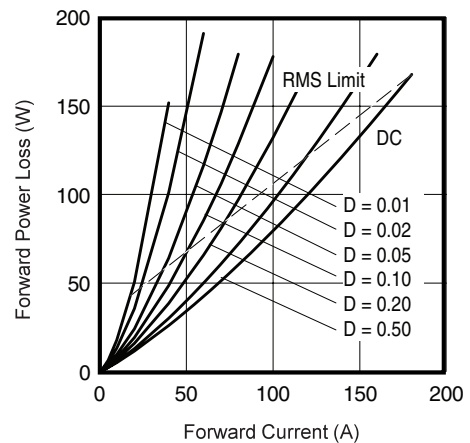

Fig. 5 - Forward Power Loss Characteristics

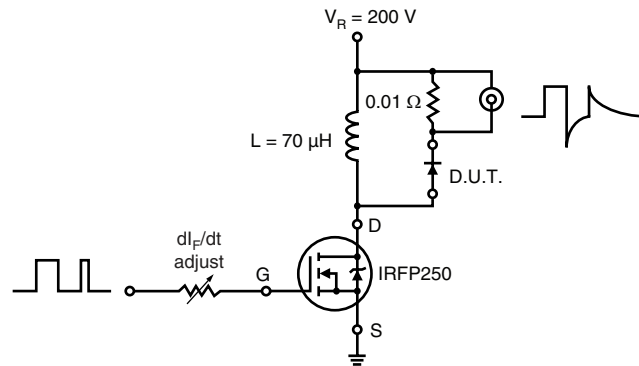
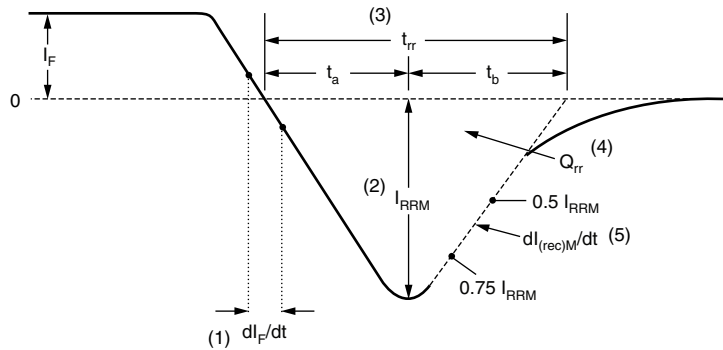

Fig. 6 - Reverse Recovery Parameter Test Circuit



- (1) dI_F/dt - rate of change of current through zero crossing
- (2) I_{RRM} - peak reverse recovery current
- (3) t_{rr} - reverse recovery time measured from zero crossing point of negative going I_F to point where a line passing through $0.75 I_{RRM}$ and $0.50 I_{RRM}$ extrapolated to zero current.
- (4) Q_{rr} - area under curve defined by t_{rr} and I_{RRM}
- (5) $dI_{(rec)M}/dt$ - peak rate of change of current during t_b portion of t_{rr}

$$Q_{rr} = \frac{t_{rr} \times I_{RRM}}{2}$$

Fig. 7 - Reverse Recovery Waveform and Definitions



FRED Pt™
Ultrafast Soft Recovery Diode,
360 A

Vishay High Power Products

ORDERING INFORMATION TABLE

Device code	VS	UD	360	C	W	40
	①	②	③	④	⑤	⑥

- 1** - Vishay HPP
- 2** - Type of device: UD = FRED Pt™
- 3** - Current rating (360 = 360 A)
- 4** - Circuit configuration:
C = Common cathode
- 5** - Type of device:
W = TO-244 wire bondable not isolated
- 6** - Voltage rating (40 = 400 V)

LINKS TO RELATED DOCUMENTS	
Dimensions	http://www.vishay.com/doc?95021



Disclaimer

All product specifications and data are subject to change without notice.

Vishay Intertechnology, Inc., its affiliates, agents, and employees, and all persons acting on its or their behalf (collectively, "Vishay"), disclaim any and all liability for any errors, inaccuracies or incompleteness contained herein or in any other disclosure relating to any product.

Vishay disclaims any and all liability arising out of the use or application of any product described herein or of any information provided herein to the maximum extent permitted by law. The product specifications do not expand or otherwise modify Vishay's terms and conditions of purchase, including but not limited to the warranty expressed therein, which apply to these products.

No license, express or implied, by estoppel or otherwise, to any intellectual property rights is granted by this document or by any conduct of Vishay.

The products shown herein are not designed for use in medical, life-saving, or life-sustaining applications unless otherwise expressly indicated. Customers using or selling Vishay products not expressly indicated for use in such applications do so entirely at their own risk and agree to fully indemnify Vishay for any damages arising or resulting from such use or sale. Please contact authorized Vishay personnel to obtain written terms and conditions regarding products designed for such applications.

Product names and markings noted herein may be trademarks of their respective owners.