

Data Sheet

Description

Avago Technologies's MGA-30489 is a 0.25W highly dynamic range Driver Amplifier MMIC, housed in a SOT-89 standard plastic package. The device features excellent input and output return loss, highly linear performance. The device can be easily matched to obtain optimum power and linearity.

MGA-30489 is especially ideal for 50Ω wireless infrastructure application such as Cellular/PCS/W-CDMA/WLL and new generation wireless technologies systems in the 250MHz to 3GHz frequency range applications. With high IP3 and low noise figure and wideband operation, the MGA-30489 may be utilized as a driver amplifier in the transmit chain and as a second stage LNA in the receive chain.

Pin connections and Package Marking

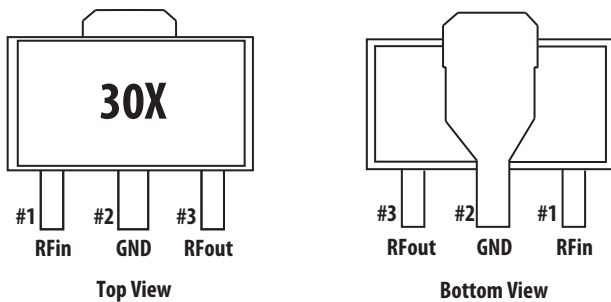

Note :
Top View : Package marking provides orientation and identification
"30" = Device Code
"X" = Date Code character identifies month of manufacturing

Attention: Observe precautions for handling electrostatic sensitive devices.
ESD Machine Model = 80 V
ESD Human Body Model = 350 V
Refer to Avago Application Note A004R:
Electrostatic Discharge, Damage and Control.

Features

- ROHS compliant
- Halogen free
- Very high linearity at low DC bias power^[1]
- Low noise figure
- High OIP3
- Advanced enhancement mode PHEMT Technology
- Excellent uniformity in product specification
- SOT-89 standard package

Specifications

At 1.9GHz, Vdd = 5V, Idd = 97mA (typ) @ 25°C

- OIP3 = 39 dBm
- Noise Figure = 3 dB
- Gain = 13.3 dB
- P1dB = 23.3 dBm
- IRL = 15dB, ORL = 14.5dB

Notes:

1. The MGA-30489 has a superior LFOM of 13dB. Linearity Figure of Merit (LFOM) is essentially OIP3 divided by DC bias power. There are few devices in the market that can match its combination of high linearity and low noise figure at the low DC bias power of 5V/97mA.

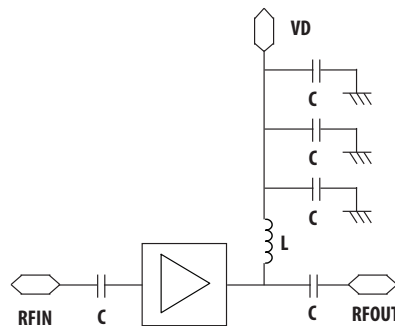

Figure 1. Simplified Schematic diagram

MGA-30489 Absolute Maximum Rating [1]

Symbol	Parameter	Units	Absolute Maximum
$I_{d,max}$	Drain Current	mA	180
$V_{d,max}$	Devices voltage, RF output to ground	V	8.4
P_{diss}	Power Dissipation [2]	mW	1512
$P_{in,max}$	CW RF Input Power	dBm	24
$T_{j,max}$	Junction Temperature	°C	150
T_{stg}	Storage Temperature	°C	-65 to 150

Thermal Resistance

Thermal Resistance [3]
($V_d = 5.0\text{ V}$) $\theta_{jc} = 50.50^\circ\text{C/W}$

Notes:

1. Operation of this device in excess of any of these limits may cause permanent damage
2. Source lead temperature is 25°C. Derate 19.8mW/°C for $T_L > 54.56^\circ\text{C}$
3. Thermal resistance measured using 150°C Infra-Red Microscopy Technique.

MGA-30489 Electrical Specification [4]

$T_C = 25^\circ\text{C}$, $Z_o = 50\Omega$, $V_d = 5\text{V}$, unless noted

Symbol	Parameter and Test Condition	Frequency	Units	Min.	Typ.	Max.
I_{ds}	Quiescent Current	N/A	mA	80	97	120
NF	Noise Figure	0.45GHz 0.9GHz 1.9GHz 2.5GHz	dB	-	2.8 3 3 3.5	3.6
Gain	Gain	0.45GHz 0.9GHz 1.9GHz 2.5GHz	dB	11.8	19.3 16.5 13.3 12	14.8
OIP3 [5]	Output Third Order Intercept Point	0.45GHz ⁽²⁾ 0.9GHz ⁽²⁾ 1.9GHz ⁽²⁾ 2.5GHz ⁽²⁾	dBm	36.5	40.5 40.5 39 39	-
P1dB	Output Power at 1dB Gain Compression	0.45GHz 0.9GHz 1.9GHz 2.5GHz	dBm	22.5	23.5 23.5 23.3 23	-
PAE	Power Added Efficiency at P1dB	0.45GHz 0.9GHz 1.9GHz 2.5GHz	%		44 43 40 37	-
IRL	Input Return Loss	0.45GHz 0.9GHz 1.9GHz 2.5GHz	dB		10.5 11 15 18	
ORL	Output Return Loss	0.45GHz 0.9GHz 1.9GHz 2.5GHz	dB		9.5 12 14.5 12	
ISOL	Isolation	0.45GHz 0.9GHz 1.9GHz 2.5GHz	dB		29 28 25.5 24	

Notes:

4. Measurements obtained from a test circuit described in Figure 43.

5. OIP3 test condition: F1 - F2 = 10MHz, with input power of -10dBm per tone measured at worst case side band.

MGA-30489 Consistency Distribution Chart [1,2]

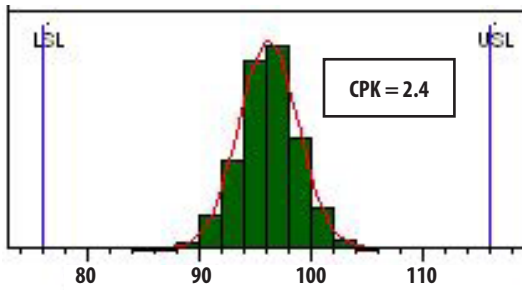

Figure 2. Idd @ 1900MHz, 5V, 97mA

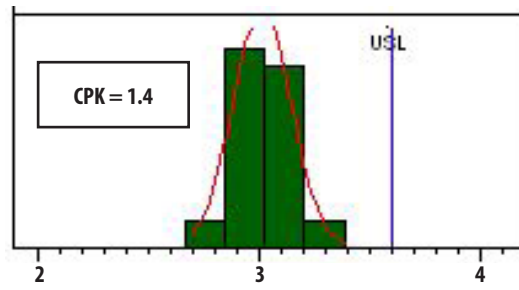

Figure 3. NF @ 1900MHz, 5V, 97mA

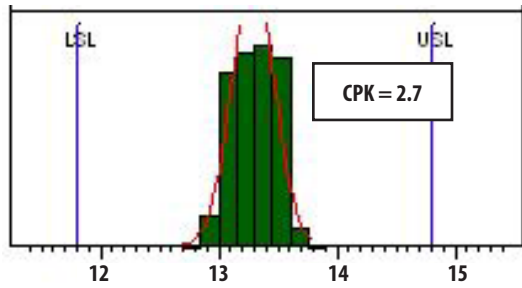

Figure 4. Gain @ 1900MHz, 5V, 97mA

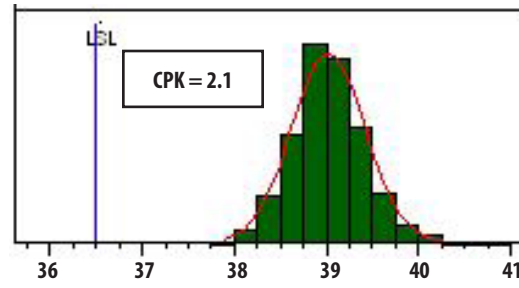

Figure 5. OIP3 @ 1900MHz, 5V, 97mA

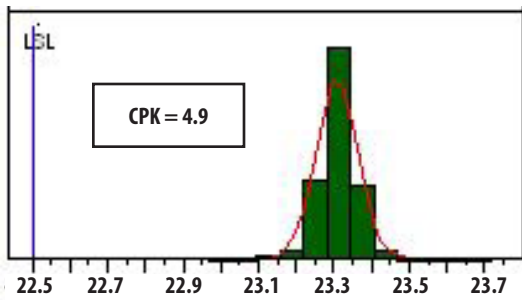

Figure 6. P1dB @ 1900MHz, 5V, 97mA

Notes:

1. Data sample size is 3000 samples taken from 2 different wafers and 2 different lots. Future wafers allocated to this product may have nominal values anywhere between the upper and lower limits
2. Measurements are made on production test board which represents a trade-off between optimal Gain, NF, OIP3 and OP1dB. Circuit losses have been de-embedded from actual measurements.

MGA-30489 Application Circuit Data for 450MHz

$T_c = 25^\circ\text{C}$, $V_d = 5.0\text{V}$, $I_d = 97\text{mA}$

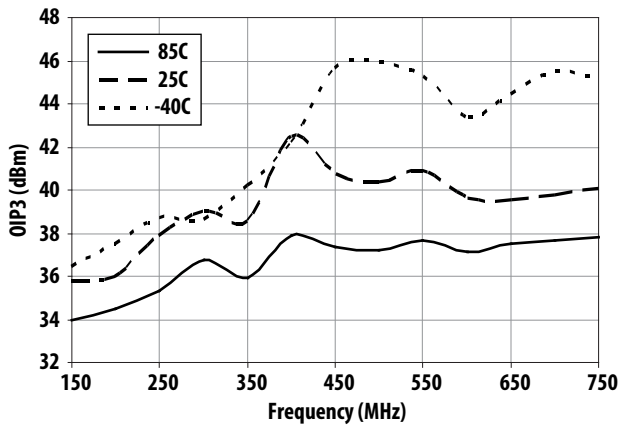

Figure 7. OIP3 vs Frequency and Temperature

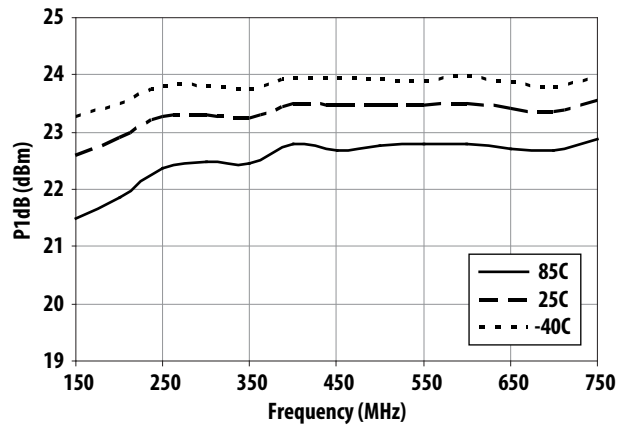

Figure 8. P1dB vs Frequency and Temperature

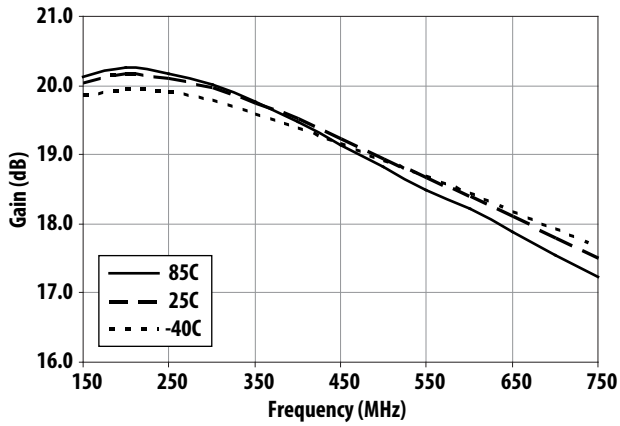

Figure 9. Gain vs Frequency and Temperature

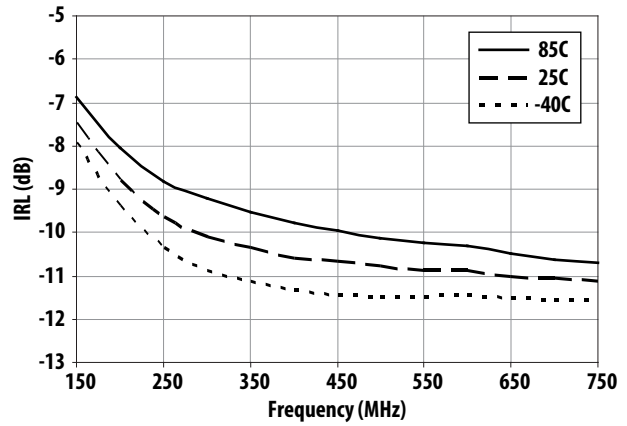

Figure 10. IRL vs Frequency and Temperature

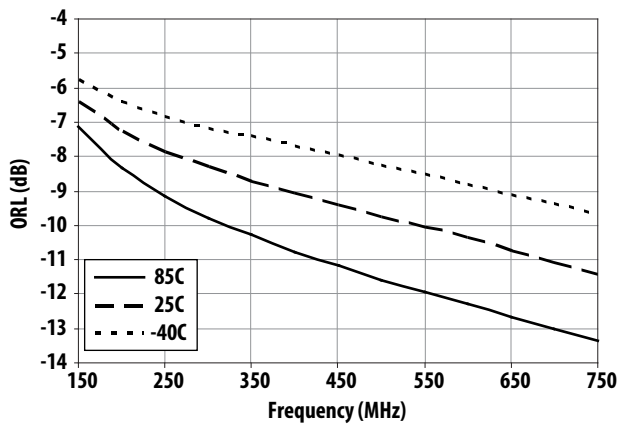

Figure 11. ORL vs Frequency and Temperature

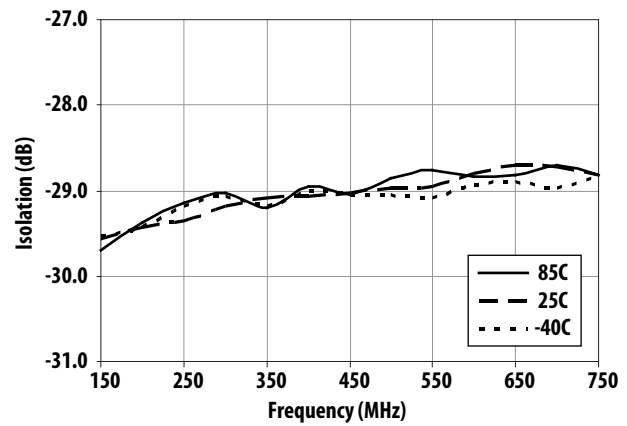

Figure 12. Isolation vs Frequency and Temperature

MGA-30489 Application Circuit Data for 450MHz (cont'd)

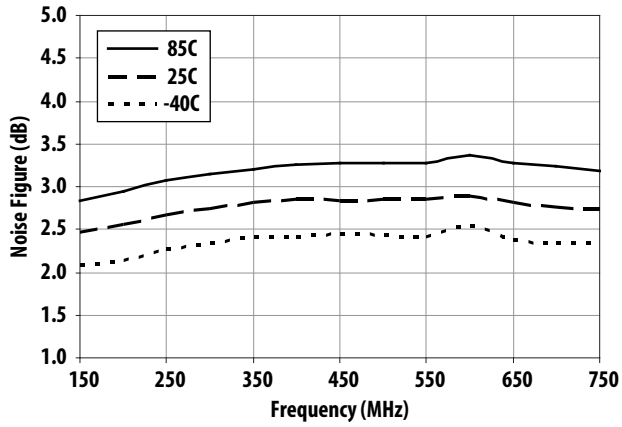

Figure 13. Noise Figure vs Frequency vs Temperature

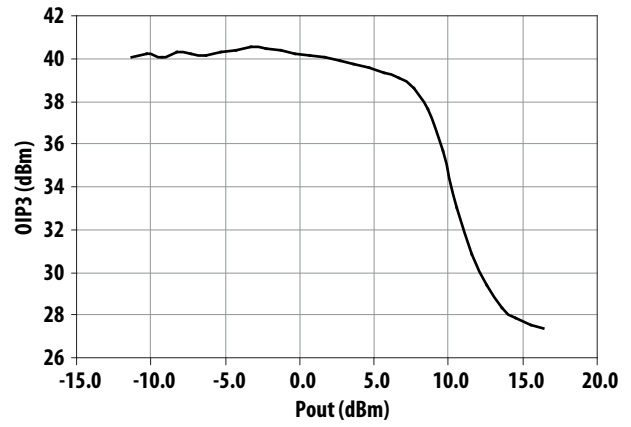

Figure 14. OIP3 vs Output Power at 450MHz

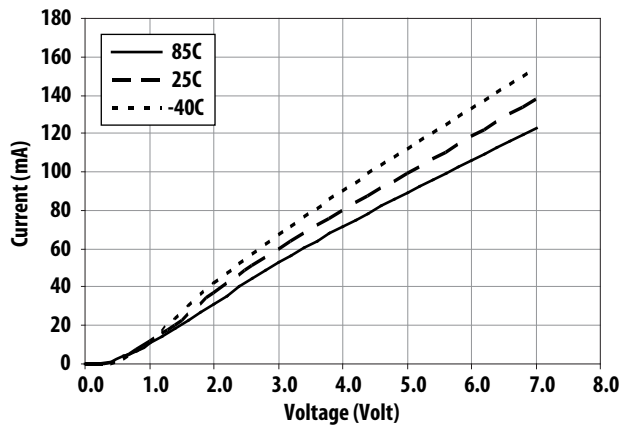

Figure 15. Current vs Voltage and Temperature

MGA-30489 Application Circuit Data for 900MHz

$T_c = 25^\circ\text{C}$, $V_d = 5.0\text{V}$, $I_d = 97\text{mA}$

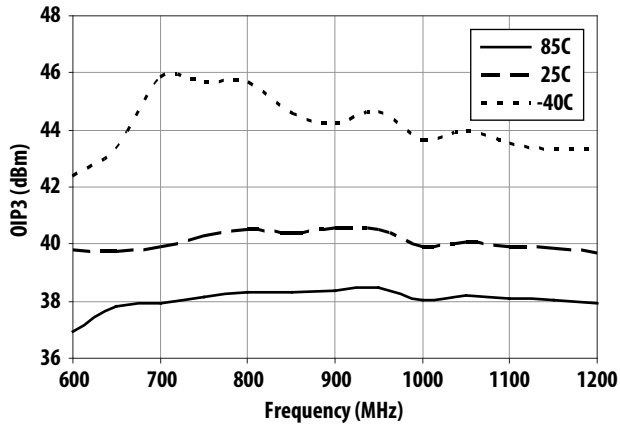

Figure 16. OIP3 vs Frequency and Temperature

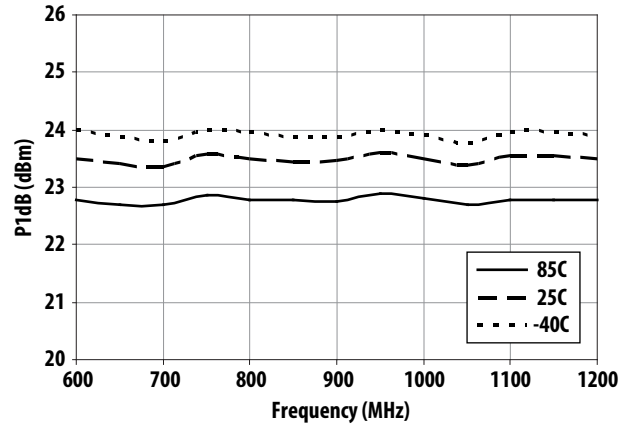

Figure 17. P1dB vs Frequency and Temperature

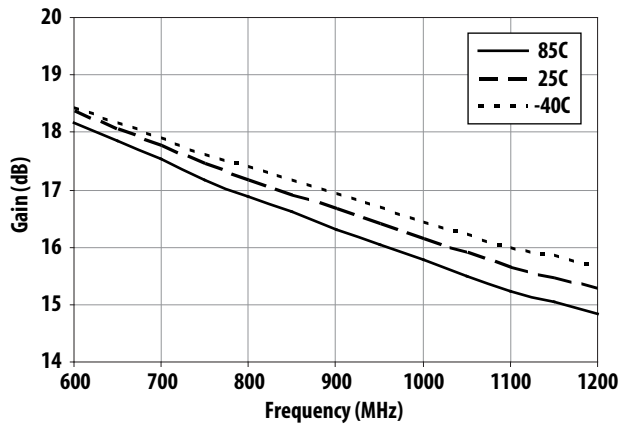

Figure 18. Gain vs Frequency and Temperature

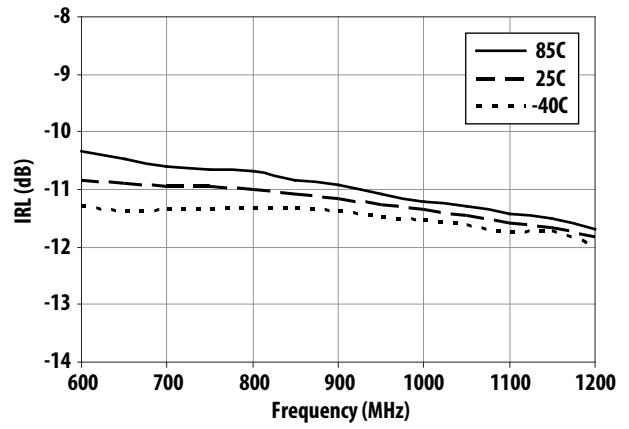

Figure 19. IRL vs Frequency and Temperature

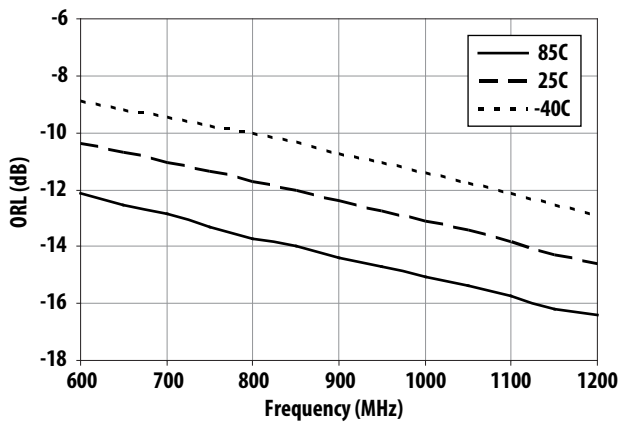

Figure 20. ORL vs Frequency and Temperature

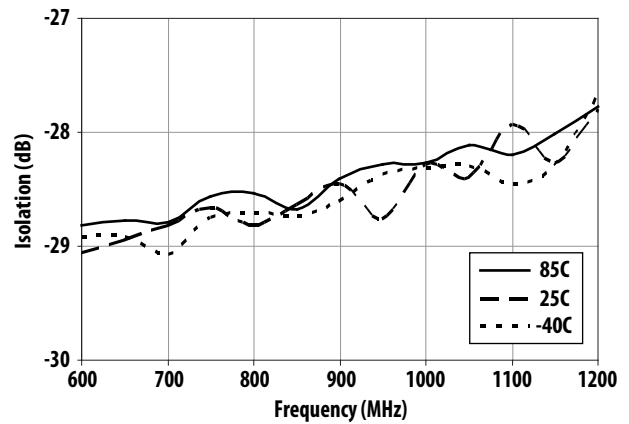

Figure 21. Isolation vs Frequency and Temperature

MGA-30489 Application Circuit Data for 900MHz (cont'd)

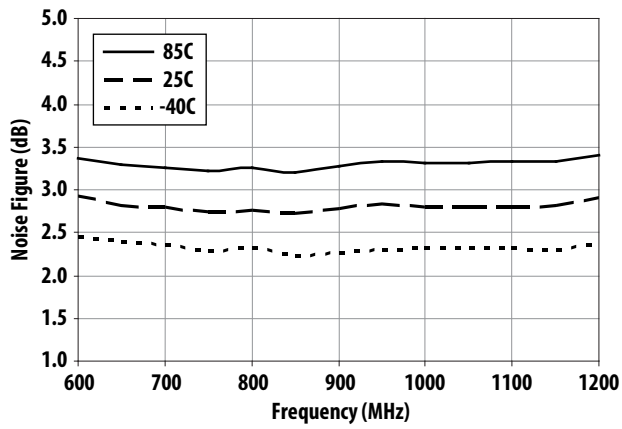

Figure 22. Noise Figure vs Frequency vs Temperature

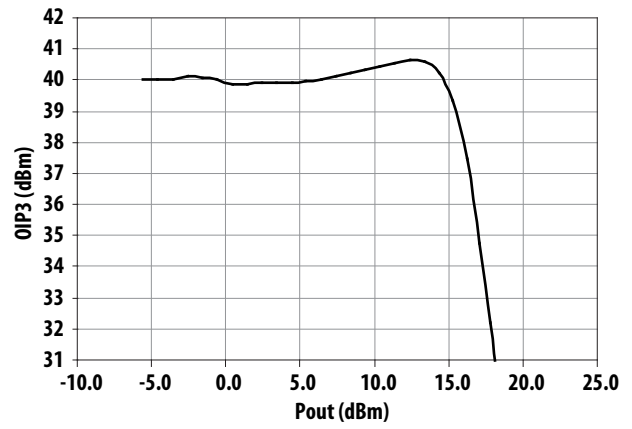

Figure 23. OIP3 vs Output Power at 1900MHz

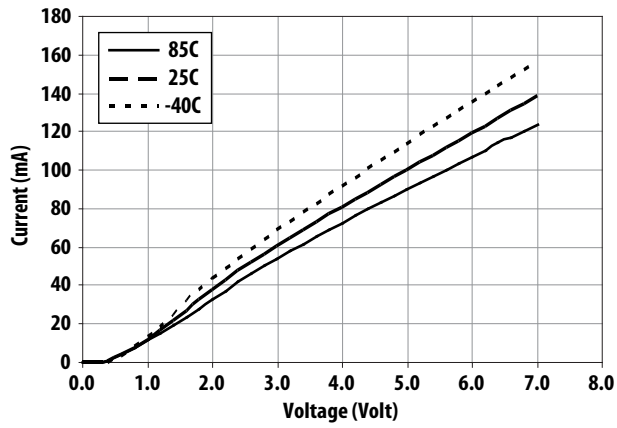

Figure 24. Current vs Voltage and Temperature

MGA-30489 Application Circuit Data for 1900MHz

$T_c = 25^\circ\text{C}$, $V_d = 5.0\text{V}$, $I_d = 97\text{mA}$

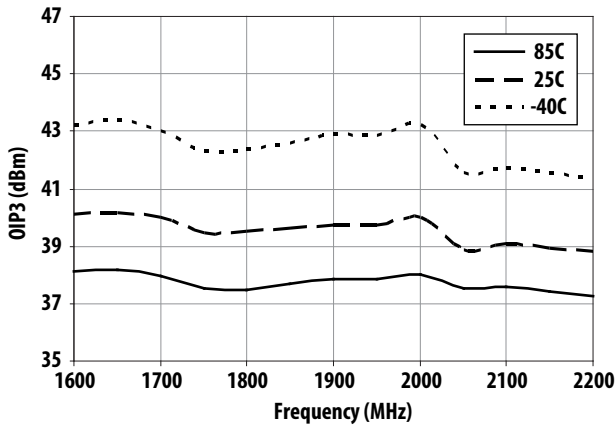

Figure 25. OIP3 vs Frequency and Temperature

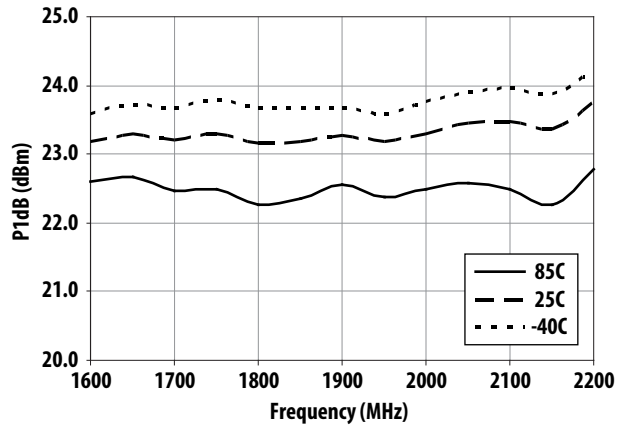

Figure 26. P1dB vs Frequency and Temperature

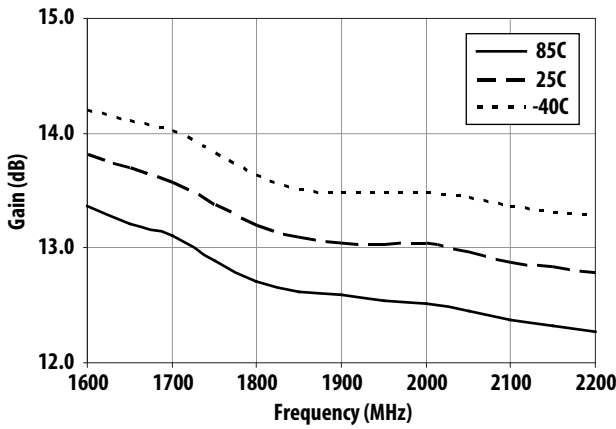

Figure 27. Gain vs Frequency and Temperature

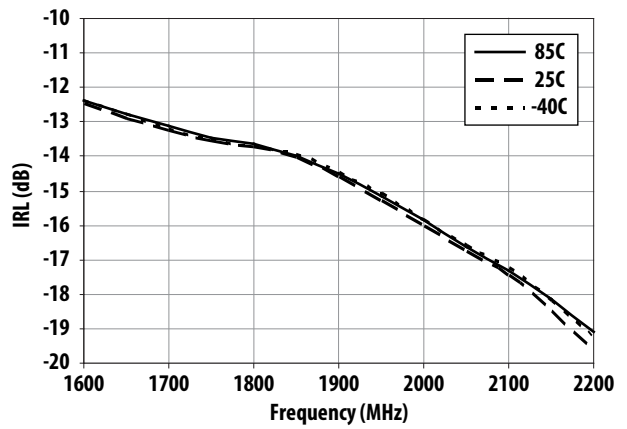

Figure 28. IRL vs Frequency and Temperature

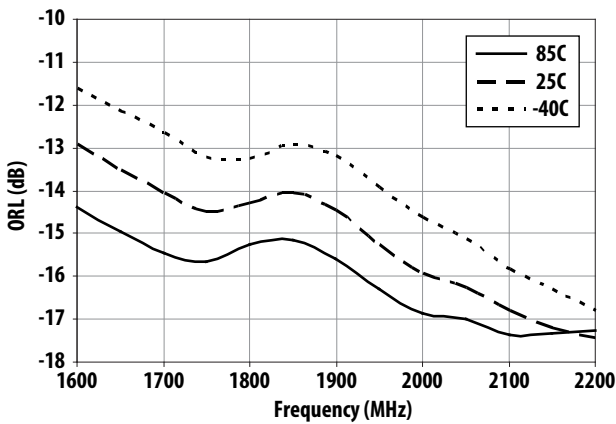

Figure 29. ORL vs Frequency and Temperature

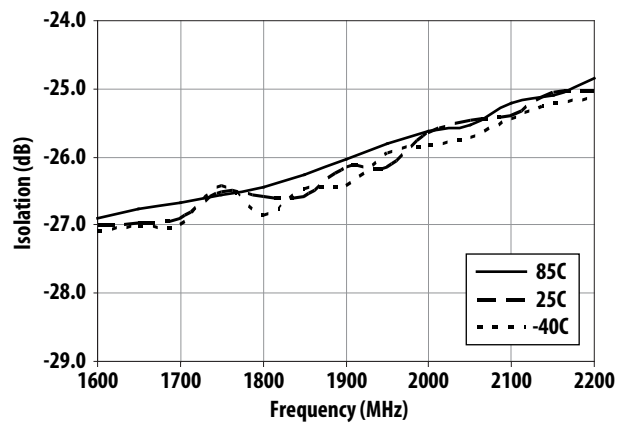

Figure 30. Isolation vs Frequency and Temperature

MGA-30489 Application Circuit Data for 1900MHz (cont'd)

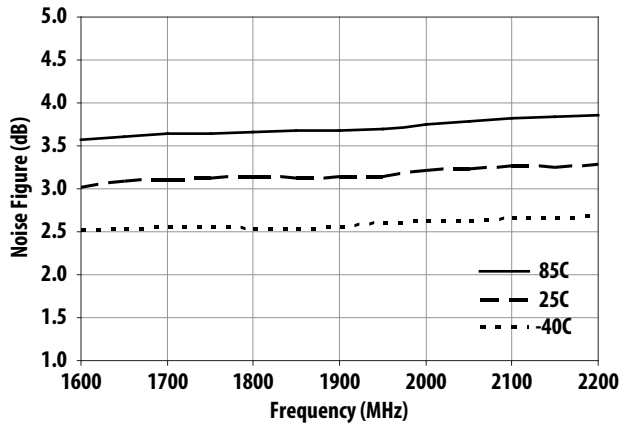

Figure 31. Noise Figure vs Frequency vs Temperature

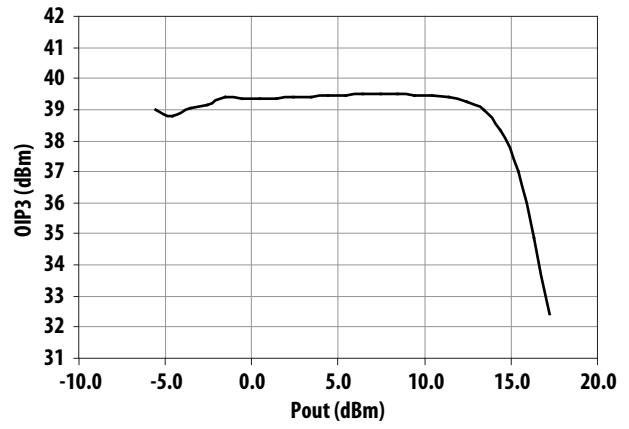

Figure 32. OIP3 vs Output Power at 1900MHz

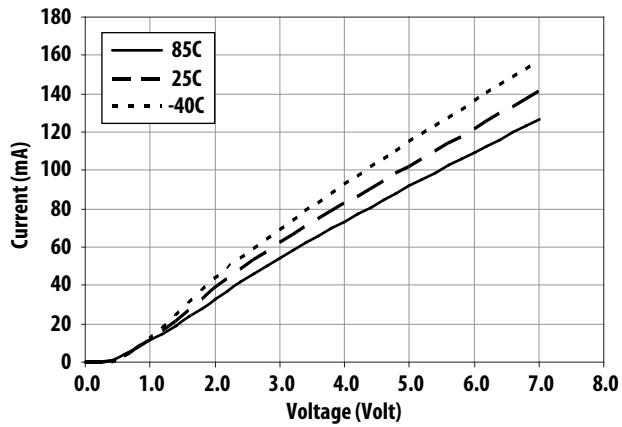

Figure 33. Current vs Voltage and Temperature

MGA-30489 Application Circuit Data for 2500MHz

$T_c = 25^\circ\text{C}$, $V_d = 5.0\text{V}$, $I_d = 97\text{mA}$

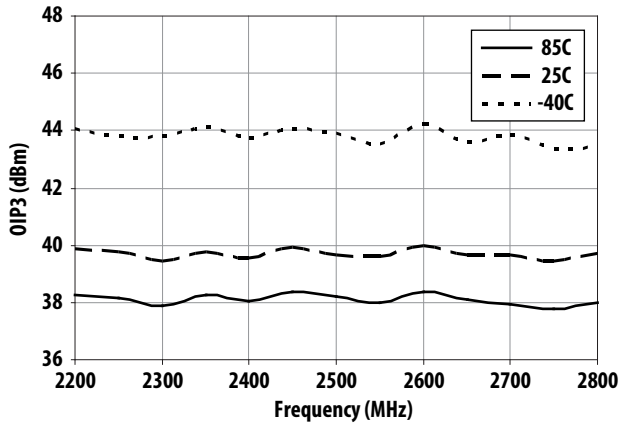

Figure 34. OIP3 vs Frequency and Temperature

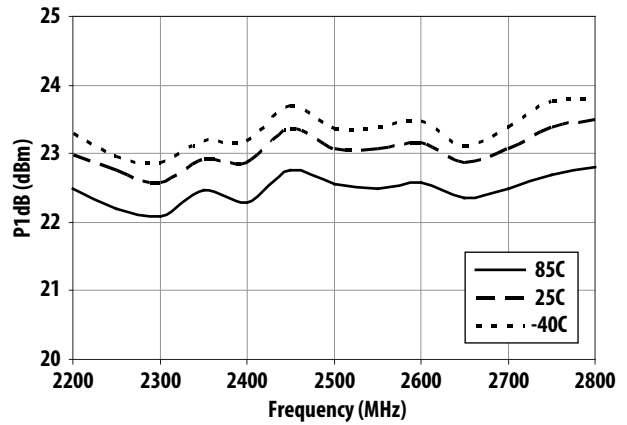

Figure 35. P1dB vs Frequency and Temperature

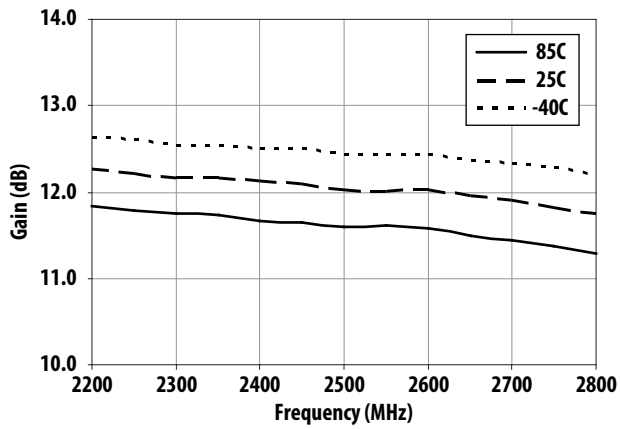

Figure 36. Gain vs Frequency and Temperature

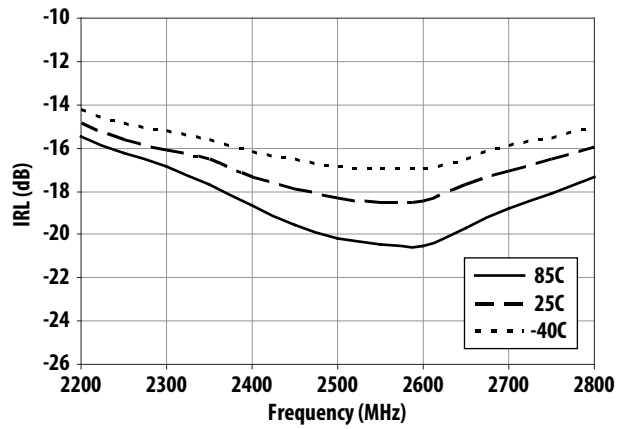

Figure 37. IRL vs Frequency and Temperature

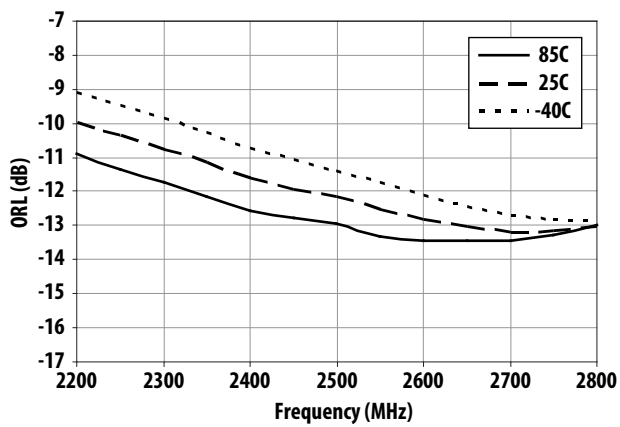

Figure 38. ORL vs Frequency and Temperature

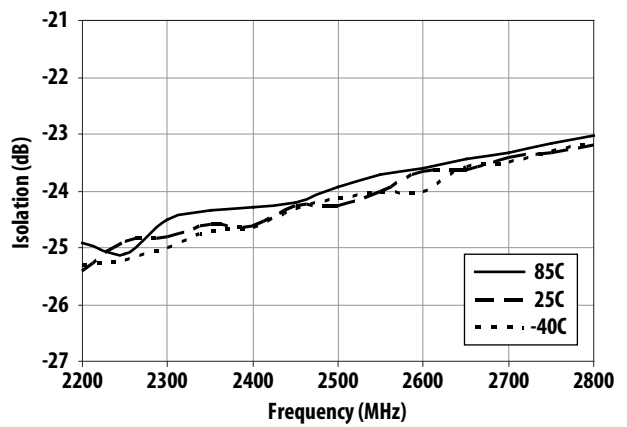

Figure 39. Isolation vs Frequency and Temperature

MGA-30489 Application Circuit Data for 2500MHz (cont'd)

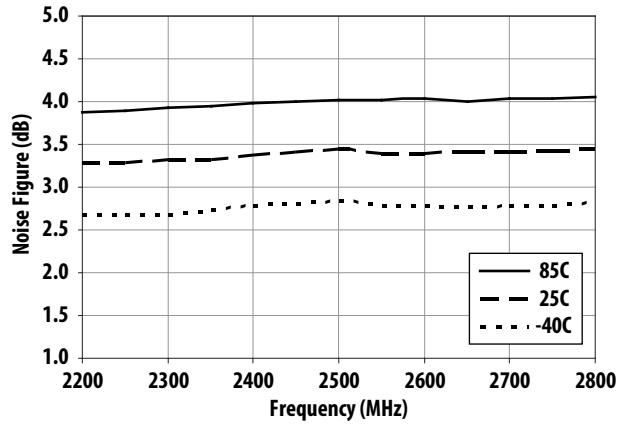

Figure 40. Noise Figure vs Frequency vs Temperature

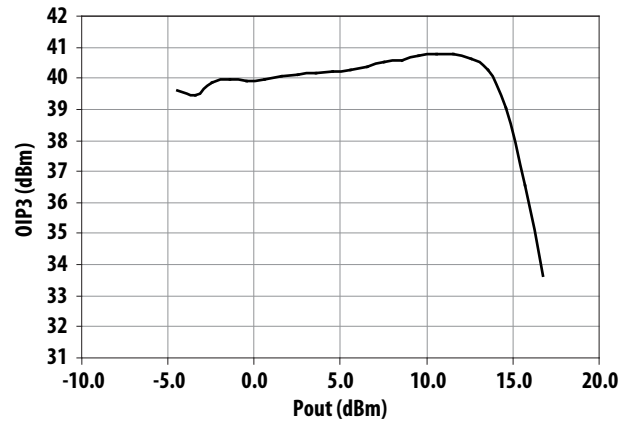

Figure 41. OIP3 vs Output Power at 1900MHz

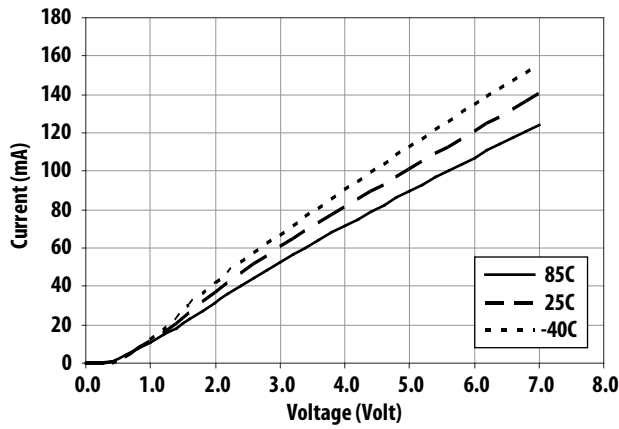

Figure 42. Current vs Voltage and Temperature

Application Circuit Description and Layout

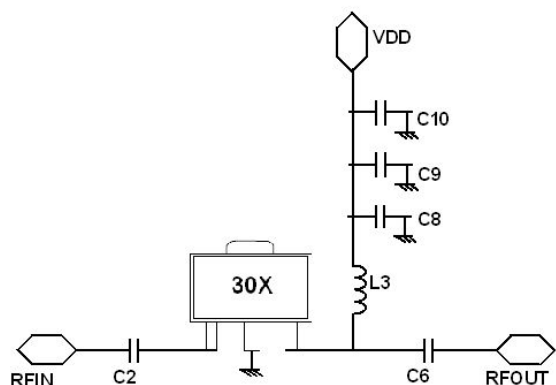

Figure 43. Circuit diagram

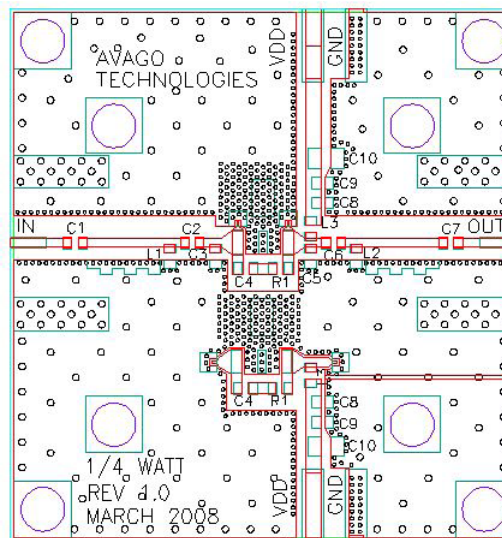

Figure 44. Demoboard

Bill of Materials

		Description							
		For 0.45GHz		For 0.9GHz		For 1.9GHz		For 2.5GHz	
Circuit Symbol	Size	Value	Manufacturer	Value	Manufacturer	Value	Manufacturer	Value	Manufacturer
C1	0402	0Ohm	NR	0Ohm	NR	0Ohm	NR	0Ohm	NR
C2	0402	100pF	MURATA	100pF	MURATA	100pF	MURATA	100pF	MURATA
C3	0402	NA	NR	NA	NR	NA	NR	NA	NR
C4	0402	NA	NR	NA	NR	NA	NR	NA	NR
C5	0402	NA	NR	NA	NR	NA	NR	NA	NR
C6	0402	100pF	MURATA	100pF	MURATA	100pF	MURATA	100pF	MURATA
C7	0402	0Ohm	NR	0Ohm	NR	0Ohm	NR	0Ohm	NR
C8	0402	10pF	MURATA	10pF	MURATA	10pF	MURATA	2.7pF	MURATA
C9	0402	0.1uF	MURATA	0.1uF	MURATA	0.1uF	MURATA	0.1uF	MURATA
C10	0603	2.2uF	MURATA	2.2uF	MURATA	2.2uF	MURATA	2.2uF	MURATA
L1	0402	NA	NR	NA	NR	NA	NR	NA	NR
L2	0402	NA	NR	NA	NR	NA	NR	NA	NR
L3	0402	47nH	MURATA	47nH	MURATA	10nH	MURATA	3.0nH	MURATA
R1	0402	NA	NR	NA	NR	NA	NR	NA	NR

Note: NR – not required in actual PCB design

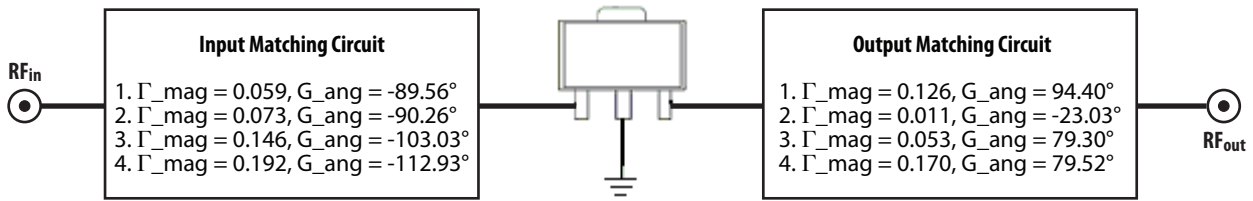

Figure 45. Gamma location for Demoboards

MGA-30489 is a input fully matched and output pre-matched component. To bias MGA-30489, a +5V supply (Vdd) is connected to the output pin thru a RF choke, L3 (which isolates the inband signal from the DC supply). The bypass capacitor helps to eliminate out of low band frequency signals from the power supply, C8, C9 and C10.

The L3 and C8 also acts as the output tuning circuitry. Blocking capacitors are required for its input (C2) and output (C6), to isolate the supply voltage from succeeding circuits. The circuit topology at its output port is changed to achieve best OIP3 while meeting typical specifications for other parameters.

MGA-30489 Typical Scatter Parameters

$T_c = 25^\circ\text{C}$, $V_d = 5.0\text{V}$, $I_d = 97\text{mA}$, $Z_0 = 50\Omega$

Freq GHz	S11	S11	S11	S21	S21	S21	S12	S12	S12	S22	S22	S22	K
	Mag.	Ang.	dB	Mag.	Ang.	dB	Mag.	Ang.	dB	Mag.	Ang.	dB	
0.10	0.186	-45.8	-14.6	11.598	159.0	21.3	0.038	3.7	-28.4	0.313	-173.9	-10.1	1.154
0.20	0.184	-61.3	-14.7	11.028	149.2	20.8	0.038	0.1	-28.3	0.300	174.2	-10.5	1.209
0.30	0.184	-86.6	-14.7	10.345	137.4	20.3	0.038	-2.2	-28.3	0.293	165.7	-10.7	1.281
0.40	0.190	-103.9	-14.4	9.696	127.0	19.7	0.038	-2.9	-28.3	0.290	154.4	-10.8	1.356
0.50	0.208	-119.2	-13.6	9.009	116.9	19.1	0.039	-4.3	-28.2	0.274	149.8	-11.3	1.425
0.60	0.220	-132.4	-13.2	8.378	107.5	18.5	0.040	-5.5	-28.0	0.260	146.4	-11.7	1.495
0.70	0.229	-144.5	-12.8	7.793	98.6	17.8	0.041	-6.9	-27.8	0.248	142.8	-12.1	1.562
0.80	0.235	-155.6	-12.6	7.280	90.5	17.2	0.042	-8.5	-27.6	0.238	139.9	-12.5	1.624
0.90	0.239	-166.4	-12.4	6.818	82.6	16.7	0.043	-10.4	-27.3	0.229	137.1	-12.8	1.681
1.00	0.242	-176.6	-12.3	6.417	75.3	16.1	0.044	-12.2	-27.1	0.219	134.6	-13.2	1.731
1.10	0.244	173.5	-12.3	6.063	68.1	15.7	0.046	-14.5	-26.8	0.212	132.0	-13.5	1.775
1.20	0.246	163.7	-12.2	5.756	61.3	15.2	0.047	-16.9	-26.5	0.202	129.8	-13.9	1.810
1.30	0.247	154.1	-12.1	5.480	54.7	14.8	0.049	-19.5	-26.2	0.194	127.5	-14.2	1.844
1.40	0.249	144.8	-12.1	5.245	48.3	14.4	0.050	-22.1	-26.0	0.184	125.5	-14.7	1.869
1.50	0.246	137.8	-12.2	5.049	42.0	14.1	0.052	-25.0	-25.7	0.172	119.1	-15.3	1.885
1.60	0.245	130.2	-12.2	4.881	35.6	13.8	0.054	-28.2	-25.3	0.169	112.7	-15.5	1.887
1.70	0.245	122.1	-12.2	4.729	29.4	13.5	0.056	-31.5	-25.1	0.162	109.0	-15.8	1.889
1.80	0.246	113.5	-12.2	4.600	23.2	13.3	0.058	-35.1	-24.8	0.155	105.6	-16.2	1.886
1.90	0.247	105.1	-12.2	4.481	16.9	13.0	0.060	-38.9	-24.5	0.147	102.0	-16.6	1.880
2.00	0.246	96.6	-12.2	4.382	10.7	12.8	0.061	-42.8	-24.2	0.139	99.5	-17.1	1.868
2.10	0.246	88.0	-12.2	4.303	4.5	12.7	0.063	-46.9	-24.0	0.132	97.0	-17.6	1.849
2.20	0.247	79.2	-12.2	4.225	-1.8	12.5	0.065	-51.2	-23.7	0.124	95.7	-18.1	1.834
2.30	0.241	69.4	-12.4	4.179	-8.0	12.4	0.068	-55.6	-23.4	0.116	94.3	-18.7	1.804
2.40	0.241	61.7	-12.4	4.149	-14.6	12.4	0.069	-60.8	-23.2	0.115	95.4	-18.8	1.778
2.50	0.235	51.9	-12.6	4.118	-21.4	12.3	0.072	-65.8	-22.9	0.107	97.1	-19.4	1.745
3.00	0.171	-5.6	-15.3	4.016	-58.2	12.1	0.079	-96.6	-22.0	0.147	121.3	-16.6	1.652
3.50	0.117	-110.8	-18.7	3.711	-97.8	11.4	0.075	-132.9	-22.5	0.287	109.1	-10.8	1.787
4.00	0.318	166.3	-9.9	3.435	-144.5	10.7	0.064	179.4	-23.8	0.459	83.8	-6.8	1.838
5.00	0.538	46.9	-5.4	1.674	122.3	4.5	0.022	35.8	-33.1	0.572	13.9	-4.9	6.495
6.00	0.651	-25.3	-3.7	0.573	60.5	-4.8	0.030	-87.5	-30.5	0.609	-30.2	-4.3	10.279
7.00	0.827	-55.2	-1.6	0.286	18.1	-10.9	0.035	-124.9	-29.1	0.723	-54.2	-2.8	6.850
8.00	0.916	-102.7	-0.8	0.155	-36.6	-16.2	0.045	178.2	-26.9	0.755	-95.3	-2.4	4.238
9.00	0.893	-154.6	-1.0	0.071	-94.6	-23.0	0.030	123.1	-30.4	0.803	-148.3	-1.9	16.074
10.00	0.878	174.6	-1.1	0.030	-135.4	-30.4	0.019	88.0	-34.3	0.860	180.0	-1.3	50.759
11.00	0.770	146.5	-2.3	0.040	-143.0	-27.9	0.012	-134.8	-38.2	0.882	157.9	-1.1	90.774
12.00	0.896	112.6	-0.9	0.034	-154.3	-29.3	0.018	-126.6	-34.7	0.886	130.7	-1.1	34.318
13.00	0.949	90.8	-0.5	0.056	172.3	-25.0	0.042	-177.8	-27.5	0.862	97.6	-1.3	6.212
14.00	0.974	50.0	-0.2	0.057	118.4	-24.9	0.047	122.2	-26.6	0.878	61.5	-1.1	2.736
15.00	0.915	14.7	-0.8	0.044	85.9	-27.1	0.038	90.0	-28.4	0.916	33.6	-0.8	8.234
16.00	0.816	-33.4	-1.8	0.043	67.0	-27.3	0.039	72.1	-28.1	0.909	10.0	-0.8	17.848
17.00	0.789	-29.7	-2.1	0.049	58.2	-26.3	0.046	61.9	-26.7	0.884	-22.5	-1.1	19.184
18.00	0.922	-73.9	-0.7	0.061	35.3	-24.3	0.059	37.7	-24.6	0.840	-56.6	-1.5	6.913
19.00	0.881	-116.5	-1.1	0.083	-7.8	-21.6	0.082	-5.9	-21.7	0.777	-85.9	-2.2	7.148
20.00	0.564	-156.7	-5.0	0.070	-53.1	-23.1	0.072	-51.1	-22.9	0.619	-117.7	-4.2	42.516

MGA-30489 Typical Noise Parameters

$T_c = 25^\circ\text{C}$, $V_d = 5.0\text{V}$, $I_d = 97\text{mA}$, $Z_o = 50\Omega$

Freq (GHz)	F_{\min} (dB)	Γ_{opt} Mag	Γ_{opt} Ang	R_n/Z_o	Ga (dB)
0.5	2.08	0.298	15.6	0.524	19.67
0.8	2.23	0.341	13.9	0.444	17.19
0.9	2.25	0.259	25.3	0.456	16.89
1	2.31	0.272	24.9	0.446	16.27
1.5	2.44	0.238	33.7	0.424	14.10
2	2.69	0.180	60.5	0.410	13.00
2.5	2.91	0.162	80.9	0.380	12.27
3	3.10	0.125	94.7	0.402	12.11
3.5	3.11	0.189	131.6	0.296	11.67
4	3.38	0.234	155.3	0.288	10.85
4.5	3.82	0.309	-179.4	0.256	9.32
5	4.96	0.437	-159.5	0.336	7.26
5.5	6.12	0.557	-134.8	0.726	5.06
6	7.27	0.633	-114.6	1.874	3.16

Part Number Ordering Information

Part Number	No of Devices	Container
MGA-30489-BLKG	100	7" Tape/Reel
MGA-30489-TR1G	3000	13" Tape/Reel

SOT89 Package Dimensions

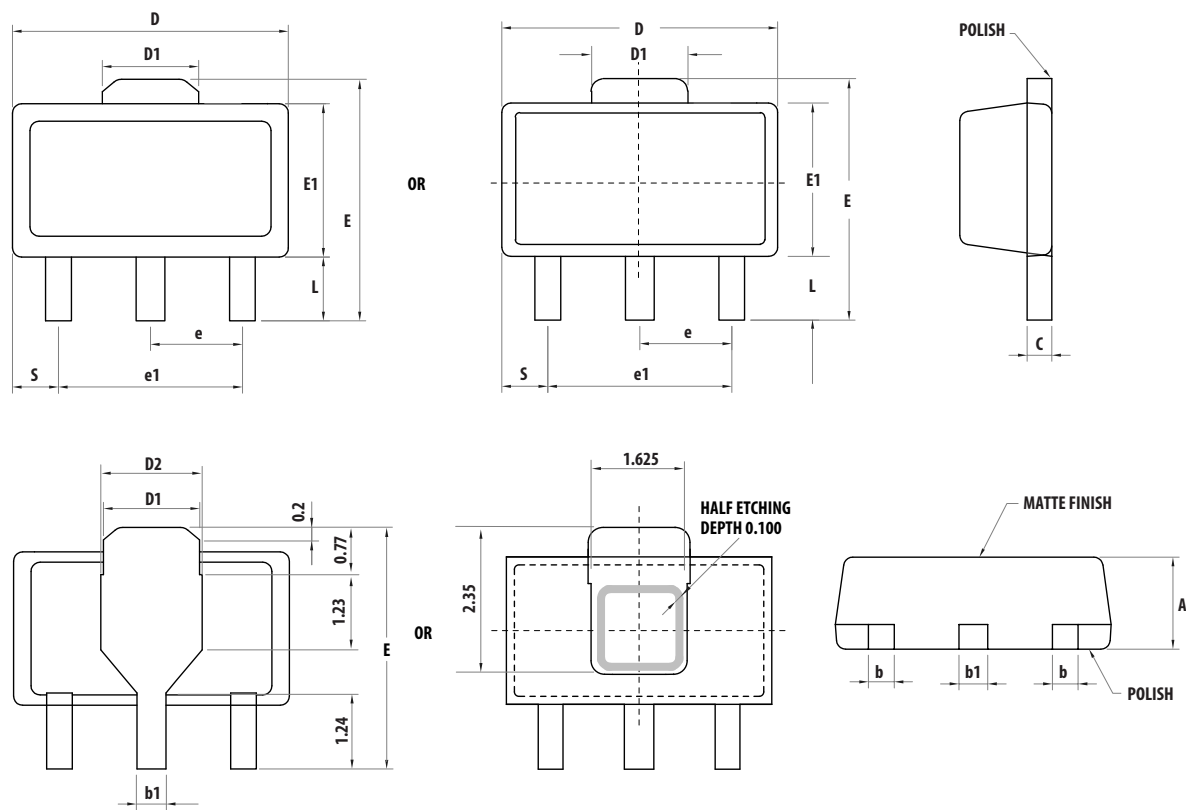

Symbols	Dimensions in mm			Dimensions in inches		
	Minimum	Nominal	Maximum	Minimum	Nominal	Maximum
A	1.40	1.50	1.60	0.055	0.059	0.063
L	0.89	1.04	1.20	0.0350	0.041	0.047
b	0.36	0.42	0.48	0.014	0.016	0.018
b1	0.41	0.47	0.53	0.016	0.018	0.030
C	0.38	0.40	0.43	0.014	0.015	0.017
D	4.40	4.50	4.60	0.173	0.177	0.181
D1	1.40	1.60	1.75	0.055	0.062	0.069
D2	1.45	1.65	1.80	0.055	0.062	0.069
E	3.94	-	4.25	0.155	-	0.167
E1	2.40	2.50	2.60	0.094	0.098	0.102
e1	2.90	3.00	3.10	0.114	0.118	0.122
S	0.65	0.75	0.85	0.026	0.030	0.034
e	1.40	1.50	1.60	0.054	0.059	0.063

Device Orientation

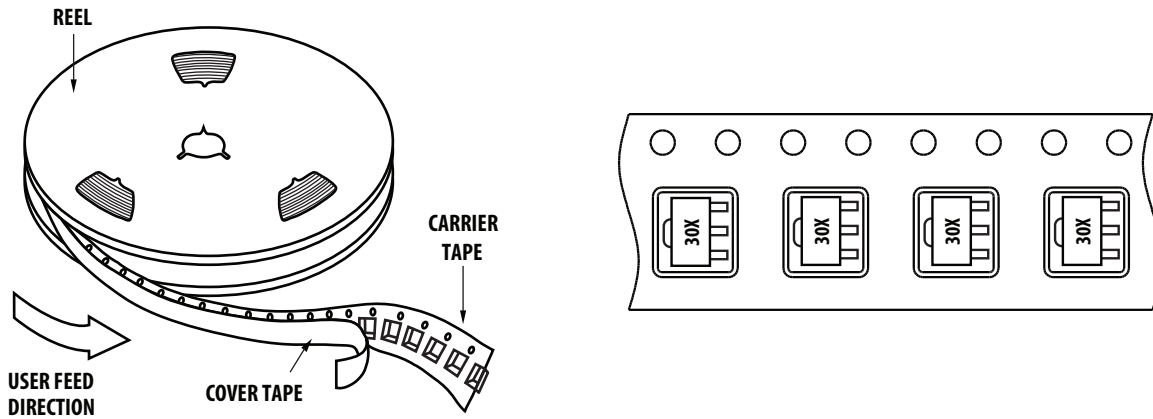

Tape Dimensions

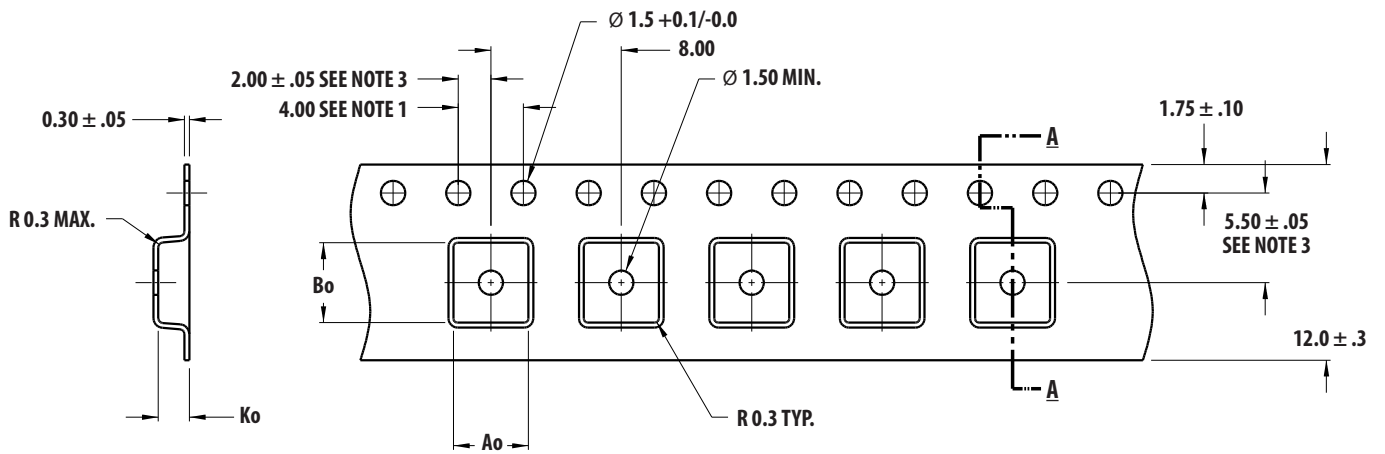

SECTION A - A

Ao = 4.60
Bo = 4.90
Ko = 1.90

DIMENSIONS IN MM

NOTES:

1. 10 SPROCKET HOLE PITCH CUMULATIVE TOLERANCE ± 0.2
2. CAMBER IN COMPLIANCE WITH EIA 481
3. POCKET POSITION RELATIVE TO SPROCKET HOLE MEASURED AS TRUE POSITION OF POCKET, NOT POCKET HOLE

Reel Dimensions – 13" Reel

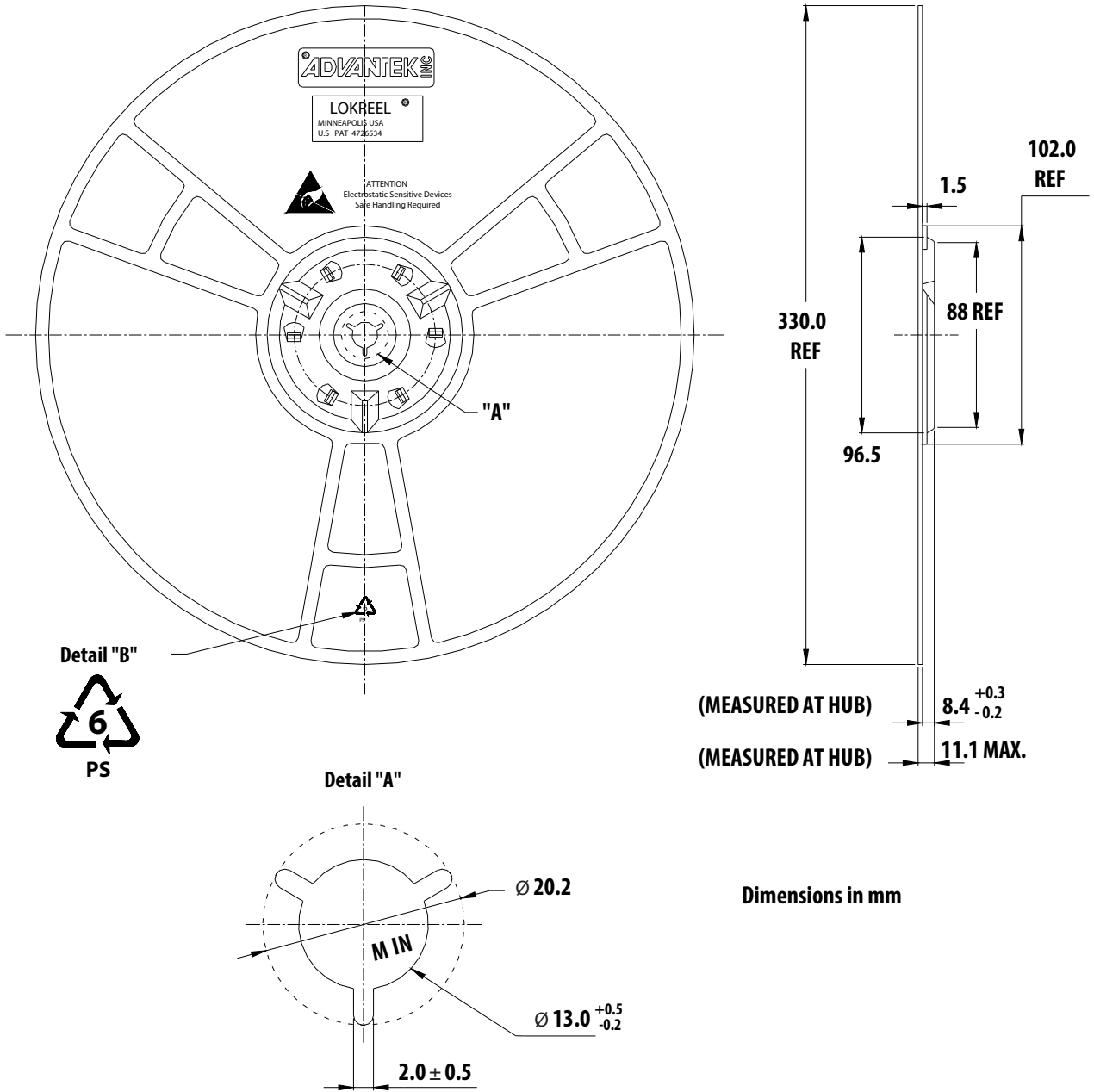

Dimensions in mm

For product information and a complete list of distributors, please go to our web site: www.avagotech.com

Avago, Avago Technologies, and the A logo are trademarks of Avago Technologies in the United States and other countries. Data subject to change. Copyright © 2005-2013 Avago Technologies. All rights reserved. AV02-1764EN - November 11, 2013

