

## SERIES 60A Joystick



### FEATURES

- Optical Encoder, Pushbutton, and Joystick in One Shaft
- Long Life, High Reliability
- Compatible with CMOS, HCMOS, and TTL Logic
- Choices of Cable Length and Termination
- Customized Solutions Available

### APPLICATIONS

- Global Positioning/Driver Information Systems
- Medical Equipment Control
- Radio Control
- Robotics
- Commercial Appliances



### DIMENSIONS In inches (and millimeters)

#### Pin Version

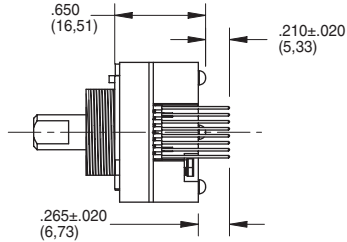
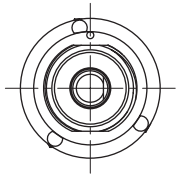

Unless otherwise specified, standard tolerance are:  
 Linear  $\pm .025$   
 Diameter  $\pm .010$   
 Angle  $\pm 2.0^\circ$

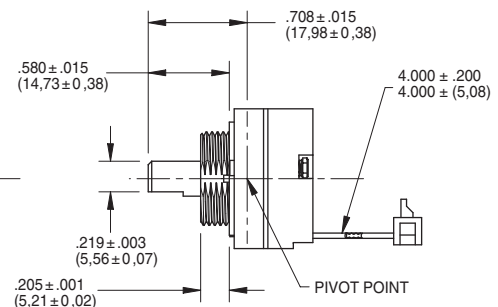
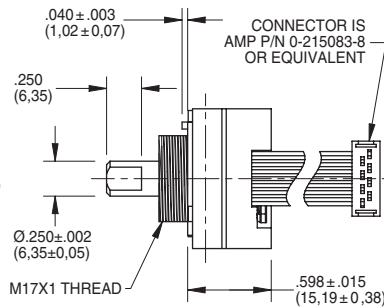
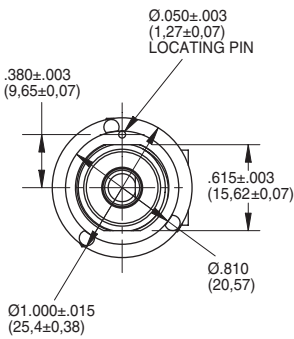
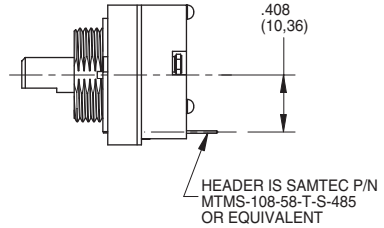

### CIRCUITRY AND JOYSTICK OPERATION Standard Quadrature 2-Bit Code

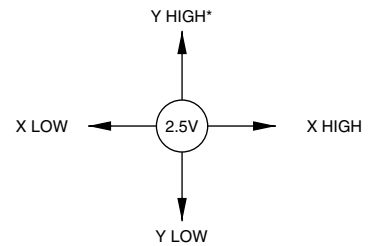
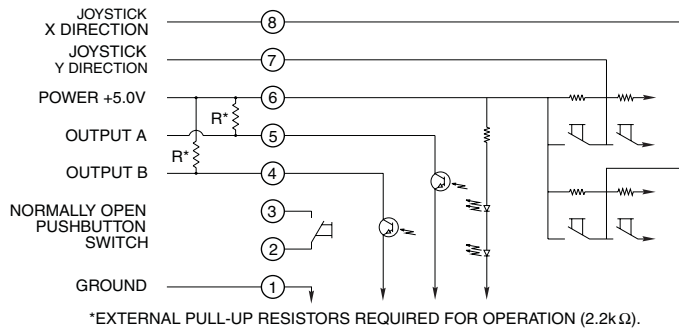

**WAVEFORM AND TRUTH TABLE** Standard Quadrature 2-Bit Code

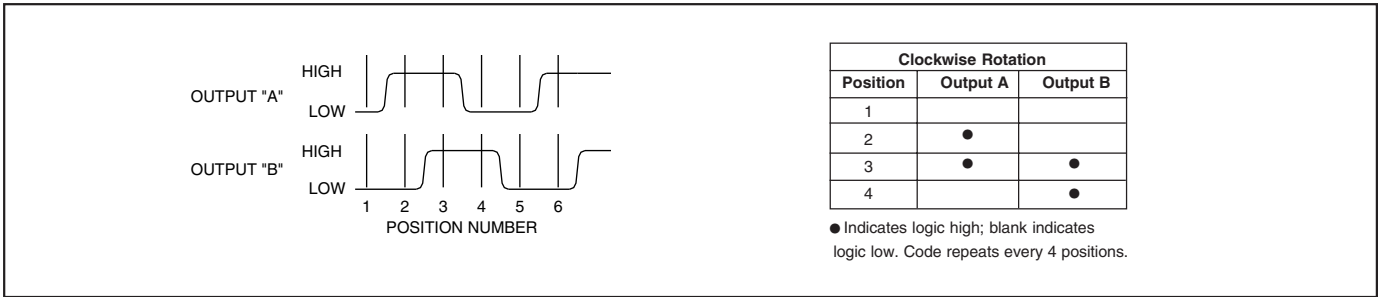

**SPECIFICATIONS**

**Rotary Electrical and Mechanical Ratings**

**Operating Voltage:** 5.00 ± 0.25 Vdc  
**Supply Current:** 20 mA maximum at 5 Vdc  
**Output:** Open collector phototransistor.  
 External pull up resistors are required  
**Output Code:** 2-Bit quadrature, channel A leads channel B by 90° electrically during clockwise rotation of the shaft  
**Logic Output Characteristics:**  
 High: No less than 3.5 Vdc  
 Low: No greater than 1.0 Vdc  
**Minimum Sink Current:** 2.0 mA  
**Power Consumption:** 100 mW maximum  
**Mechanical Life:** 1 million rotational cycles of operation (1 cycle is a rotation through all positions and a full return)  
**Average Rotational Torque:** 2.0 ± 1.0 in-oz initially, torque shall be within 50% of initial value throughout life  
**Mounting Torque:** 15 in-lbs. maximum  
**Shaft Push-Out Force:** 45 lbs minimum  
**Shaft Pull-Out Force:** 45 lbs minimum  
**Terminal Strength:** 15 lbs terminal pull-out force minimum for cabled and header termination  
**Solderability:** 95% free of pin holes and voids

**Pushbutton Electrical and Mechanical Ratings**

**Rating:** 10 mA at 5 Vdc resistive  
**Contact Resistance:** less than 10 ohms  
**Life:** 1 million actuations minimum  
**Contact Bounce:** < 4 mS make, 10 mS break  
**Actuation Force:** 400 ± 150 grams force  
**Shaft Travel:** 0.020 ± 0.010 inches

**Joystick Electrical and Mechanical Ratings**

**Supply Current:** 5 mA maximum  
**Output Code:** 2-Bit  
**Logic Output Characteristics:**  
 Neutral: 2.5 ± 0.5 Vdc  
 High: > 4.5 Vdc  
 Low: < 0.5 Vdc  
**Angle of Throw:** 8° ± 2° in all directions  
**Life:** 500,000 actuations in each direction

**Environmental Ratings**

**Operating Temperature Range:** -40°C to 85°C  
**Storage Temperature Range:** -55°C to 100°C  
**Relative Humidity:** 96 hours at 90-85% humidity at 40°C  
**Vibration:** Harmonic motion with amplitude of 15g, within a varied 10 to 2000 Hz frequency for 12 hours  
**Mechanical Shock:**  
 Test 1: 100g for 6ms half-sine wave with a velocity change of 12.3 ft/s  
 Test 2: 100g for 6ms sawtooth wave with a velocity change of 9.7 ft/s

**Materials and Finishes**

**Assembly Studs:** 305 Stainless steel  
**Detent Housing:** Polyamide polymer (nylon 6/10 alloy)  
**Printed Circuit Boards:** Glass cloth epoxy double clad with copper gold over nickel plated  
**Infrared Emitting Diode Chips:** Gallium aluminum arsenide  
**Silicon Phototransistor Chips:** Gold and aluminum alloys

**Resistors:** Metal oxide on ceramic substrate

**Solder Pins:** Brass, Plated with tin

**Shaft:** Polyamide polymer (nylon 6/10 alloy) with stainless steel insert

**Detent Balls:** Carbon steel plated with nickel

**Detent Springs:** Music wire plated with tin

**Code Rotor:** 33% Glass reinforced nylon 66

**Pushbutton Dome:** Stainless steel

**Pushbutton Dome Retainer:** Polycarbonate

**Joystick Housing:** Polyamide polymer (nylon 6/10 alloy)

**Joystick Contact:** Stainless steel, silicone rubber, brass with silver cladding, high-temp thermoplastic, phosphor bronze with silver cladding

**Cable:** Copper stranded with plating in PVC insulation

**Connector:** PA 4.6 with tin over nickel plated phosphor bronze

**Lockwashers:** Stainless steel with passivate finish

**Hex Nuts:** 303 Stainless steel

**Label:** TT406 Thermal transfer cast film

**Solder:** Sn/Ag/Cu, Lead-Free, No Clean

**Mounting Nut:** Polyurethane

**Lubricating Grease:** Nye nyogel 774L

**OPTIONS**

Contact Grayhill for custom terminations, rotational torque, number of positions, shaft configurations, and resolutions. Control knobs are also available.

**ORDERING INFORMATION**

**60A18-4-040S**

**Series**  
**Angle of Throw:** Detent: 18 = 18° or 20 positions; Non-detent: 08 = 18° or 20 positions; Non-Turn: 00 = Joystick and Pushbutton only  
**Joystick Contacts:** 2 = 2 Discrete Contacts  
 4 = 4 Discrete Contacts  
 8 = 4 Contacts in 8 possible directions  
**Termination:** S = Stripped cable; .050" centers; C = Connector; .050" centers; P = Pin; .050" centers  
**Cable Termination:** 040 = 4.0in. Cable is terminated with Amp Connector P/N 215083-6.  
 See Amp Mateability Guide for mating connector details.  
*\*Eliminate cable length if ordering pins (Ex: 60A18-4-P)*

Available from your local Grayhill Component Distributor. For prices and discounts, contact a local Sales Office, an authorized local Distributor, or Grayhill.

Optical and Mechanical Encoders