

**NV Series: 4 - 6W DC/DC Converters**  
**9-36V, 18-36V, 36-72V & 16-75V Inputs**  
**3.3V, 5.0V, 12V, 15V,  $\pm 5.0V$ ,  $\pm 12V$ ,  $\pm 15V$  &  $\pm 24V$  Outputs**



### Applications

- Distributed power architectures
- Telecommunications equipment
- LAN/WAN applications
- Data processing

### Features

- Single board design
- 8.5 mm height profile
- Excellent co-planarity
- Input/output isolation: 1500 Vdc
- Low conducted and radiated EMI
- Output overcurrent protection
- Parallel and series connection providing flexible output voltages and power
- Full rated output power at 71°C with convection cooling
- Operating temperature to 110°C
- UL, CSA and EN/IEC60950 (3<sup>rd</sup> ed.) approved

### Description

The NV series of converters are low profile, single and dual outputs, DC/DC converters intended for SMT placement and reflow soldering. The product provides on-board conversion of a wide range of standard telecom and datacom input voltages to isolated low output voltages. Proprietary patented manufacturing process with full process automation ensures optimal product quality in an extremely small footprint.

| Selection Chart – Single output |                    |                         |                          |                                    |                                |               |
|---------------------------------|--------------------|-------------------------|--------------------------|------------------------------------|--------------------------------|---------------|
| Model                           | Input voltage, Vdc | Input current, max, Adc | Output voltage, Vdc (Vo) | Output rated current, Adc (Io.Max) | Output ripple and noise, mVp-p | Efficiency, % |
| NVS01YG-M6                      | 18-36              | 0.27                    | 5.0                      | 1.0                                | 50                             | 82            |
| NVS0.5YH-M6                     | 18-36              | 0.33                    | 12                       | 0.5                                | 95                             | 83            |
| NVS0.4YJ-M6                     | 18-36              | 0.33                    | 15                       | 0.4                                | 120                            | 84            |
| NVS01ZE-M6                      | 36-75              | 0.17                    | 5.0                      | 1.0                                | 50                             | 82            |
| NVS0.5ZH-M6                     | 36-75              | 0.17                    | 12                       | 0.5                                | 95                             | 82            |
| NVS0.4ZJ-M6                     | 36-75              | 0.17                    | 15                       | 0.4                                | 120                            | 84            |
| NVS0.9CE-M6                     | 9-36               | 0.45                    | 3.3                      | 0.9                                | 50                             | 79            |
| NVS0.7CG-M6                     | 9-36               | 0.55                    | 5.0                      | 0.7                                | 50                             | 81            |
| NVS0.3CH-M6                     | 9-36               | 0.65                    | 12                       | 0.34                               | 95                             | 82            |
| NVS0.3CJ-M6                     | 9-36               | 0.65                    | 15                       | 0.28                               | 120                            | 82            |
| NVS0.9EE-M6                     | 18-75              | 0.33                    | 3.3                      | 0.9                                | 50                             | 80            |
| NVS0.7EG-M6                     | 18-75              | 0.33                    | 5.0                      | 0.7                                | 50                             | 81            |
| NVS0.3EH-M6                     | 18-75              | 0.33                    | 12                       | 0.34                               | 95                             | 82            |
| NVS0.3EJ-M6                     | 18-75              | 0.33                    | 15                       | 0.28                               | 120                            | 82            |

Continued next page



**NV Series: 4 - 6W DC/DC Converters**  
**9-36V, 18-36V, 36-72V & 16-75V Inputs**  
**3.3V, 5.0V, 12V, 15V, ±5.0V, ±12V, ±15V & ±24V Outputs**

Continued from previous page

| Selection Chart – Dual Outputs |                    |                         |                          |                                    |                                |               |
|--------------------------------|--------------------|-------------------------|--------------------------|------------------------------------|--------------------------------|---------------|
| Model                          | Input voltage, Vdc | Input current, max, Adc | Output voltage, Vdc (Vo) | Output rated current, Adc (Io.Max) | Output ripple and noise, mVp-p | Efficiency, % |
| NVD01YGG-M6                    | 18-36              | 0.27                    | ±5.0                     | ±0.50                              | 60                             | 82            |
| NVD0.5YHH-M6                   | 18-36              | 0.33                    | ±12                      | ±0.25                              | 100                            | 83            |
| NVD0.3YJJ-M6                   | 18-36              | 0.33                    | ±15                      | ±0.14                              | 120                            | 84            |
| NVD01ZGG-M6                    | 36-75              | 0.17                    | ±5.0                     | ±0.50                              | 60                             | 82            |
| NVD0.5ZHH-M6                   | 36-75              | 0.17                    | ±12                      | ±0.25                              | 100                            | 83            |
| NVD0.3ZJJ-M6                   | 36-75              | 0.17                    | ±15                      | ±0.14                              | 120                            | 84            |
| NVD0.7CGG-M6                   | 9-36               | 0.65                    | ±5.0                     | ±0.35                              | 50                             | 81            |
| NVD0.3CHH-M6                   | 9-36               | 0.65                    | ±12                      | ±0.17                              | 95                             | 82            |
| NVD0.3CJJ-M6                   | 9-36               | 0.65                    | ±15                      | ±0.14                              | 120                            | 82            |
| NVD0.1CKK-M6                   | 9-36               | 0.65                    | ±24                      | ±0.08                              | 190                            | 83            |
| NVD0.7EGG-M6                   | 18-75              | 0.33                    | ±5.0                     | ±0.35                              | 50                             | 81            |
| NVD0.3EHH-M6                   | 18-75              | 0.33                    | ±12                      | ±0.17                              | 95                             | 82            |
| NVD0.3EJJ-M6                   | 18-75              | 0.33                    | ±15                      | ±0.14                              | 120                            | 82            |
| NVD0.1E KK-M6                  | 18-75              | 0.33                    | ±24                      | ±0.08                              | 190                            | 83            |

### Absolute Maximum Ratings

Stresses in excess of the absolute maximum ratings may cause performance degradation, adversely affect long term reliability and cause permanent damage to the converter. Specifications apply over specified input voltage, output load and temperature range, unless otherwise noted.

| Parameter                | Conditions/Description | Min | Max | Units |
|--------------------------|------------------------|-----|-----|-------|
| Operating CaseTemp. (Tc) | At 100% load           | -40 | 110 | °C    |
| Storage Temperature (Ts) |                        | -55 | 120 | °C    |

### Environmental and Mechanical Specifications

| Parameter            | Conditions/Description     | Min | Nom   | Max    | Units |
|----------------------|----------------------------|-----|-------|--------|-------|
| Shock                | IEC68-2-27                 |     |       | 100    | g     |
| Sinusoidal Vibration | IEC68-2-6                  |     |       | 10     | g     |
| Weight               |                            |     |       | 0.4/12 | oz/g  |
| Water Washing        | Standard process           | Yes |       |        | N/A   |
| MTBF                 | Per Bellcore TR-NWT-000332 |     | 3,000 |        | kHrs  |

### Isolation Specifications

| Parameter                   | Conditions/Description  | Min         | Nom   | Max   | Units |
|-----------------------------|-------------------------|-------------|-------|-------|-------|
| Insulation Safety Rating    | Vin = Vin.Min – Vin.Max | Operational |       |       | N/A   |
| Isolation Voltage (Vps)     |                         |             |       | 1,500 | Vdc   |
| Isolation Resistance (Rps)  |                         | 10          |       |       | MOhm  |
| Isolation Capacitance (Cps) |                         |             | 1,100 |       | pF    |



**NV Series: 4 - 6W DC/DC Converters**  
**9-36V, 18-36V, 36-72V & 16-75V Inputs**  
**3.3V, 5.0V, 12V, 15V,  $\pm 5.0V$ ,  $\pm 12V$ ,  $\pm 15V$  &  $\pm 24V$  Outputs**

### Input Specifications (9-36V)

| Parameter                       | Conditions/Description                 | Min | Nom       | Max  | Units    |
|---------------------------------|--|-----|-----------|------|----------|
| Input voltage (Vin)             | Continuous                             | 9   |           | 36   | Vdc      |
| Transient Input Voltage (Vint)  | Transient, 100ms                       |     |           | 40   | Vdc      |
| Input Current when Shutdown     | Vin.Nom, Iout = 0A                     |     | 10        | 20   | mAdc     |
| Turn-On Input Voltage 9-36 Vin  | Ramping Up, Io.Max                     | 8   | 8.5       | 9    | Vdc      |
| Turn-Off Input Voltage 9-36 Vin | Ramping Down, Io.Max                   | 8   | 8.5       | 9    | Vdc      |
| Turn-On Time                    | To Output Regulation Band<br>Rise Time |     | 250<br>10 | 500  | ms<br>ms |
| Input Reflected Ripple Current  | Vin.Max, Io.Max                        |     |           | 30   | mAp-p    |
| Input Capacitance               |  |     |           | 0.6  | $\mu F$  |
| Switching Frequency             | Vin.Nom, Io.Max                        |     | 250       |      | kHz      |
| Temperature Coefficient         |  |     |           | 0.02 | %Vo/°C   |

### Input Specifications (18-36V)

| Parameter                       | Conditions/Description                 | Min | Nom       | Max | Units    |
|---------------------------------|--|-----|-----------|-----|----------|
| Input voltage (Vin)             | Continuous                             | 18  |           | 36  | Vdc      |
| Transient Input Voltage (Vint)  | Transient, 100ms                       |     |           | 40  | Vdc      |
| Input Current when Shutdown     | Vin.Nom, Iout = 0A                     |     | 10        | 20  | mAdc     |
| Turn-On Input Voltage 9-36 Vin  | Ramping Up, Io.Max                     | 16  | 17        | 18  | Vdc      |
| Turn-Off Input Voltage 9-36 Vin | Ramping Down, Io.Max                   | 16  | 17        | 18  | Vdc      |
| Turn-On Time                    | To Output Regulation Band<br>Rise Time |     | 250<br>10 | 500 | ms<br>ms |
| Input Reflected Ripple Current  | Vin.Max, Io.Max                        |     |           | 30  | mAp-p    |
| Input Capacitance               |  |     |           | 0.6 | $\mu F$  |

### Input Specifications (16-75V)

| Parameter                       | Conditions/Description                 | Min | Nom       | Max | Units    |
|---------------------------------|--|-----|-----------|-----|----------|
| Input voltage (Vin)             | Continuous                             | 16  |           | 75  | Vdc      |
| Transient Input Voltage (Vint)  | Transient, 100ms                       |     |           | 100 | Vdc      |
| Input Current when Shutdown     | Vin.Nom, Iout = 0A                     |     | 8         | 10  | mAdc     |
| Turn-On Input Voltage 9-36 Vin  | Ramping Up, Io.Max                     | 14  | 15        | 16  | Vdc      |
| Turn-Off Input Voltage 9-36 Vin | Ramping Down, Io.Max                   | 14  | 15        | 16  | Vdc      |
| Turn-On Time                    | To Output Regulation Band<br>Rise Time |     | 250<br>10 | 500 | ms<br>ms |
| Input Reflected Ripple Current  | Vin.Max, Io.Max                        |     |           | 30  | mAp-p    |
| Input Capacitance               |  |     |           | 0.3 | $\mu F$  |

### Input Specifications (36-75V)

| Parameter                       | Conditions/Description                 | Min | Nom       | Max | Units    |
|---------------------------------|--|-----|-----------|-----|----------|
| Input voltage (Vin)             | Continuous                             | 36  |           | 75  | Vdc      |
| Transient Input Voltage (Vint)  | Transient, 100ms                       |     |           | 100 | Vdc      |
| Input Current when Shutdown     | Vin.Nom, Iout = 0A                     |     | 8         | 10  | mAdc     |
| Turn-On Input Voltage 9-36 Vin  | Ramping Up, Io.Max                     | 32  | 34        | 36  | Vdc      |
| Turn-Off Input Voltage 9-36 Vin | Ramping Down, Io.Max                   | 32  | 34        | 36  | Vdc      |
| Turn-On Time                    | To Output Regulation Band<br>Rise Time |     | 250<br>10 | 500 | ms<br>ms |
| Input Reflected Ripple Current  | Vin.Max, Io.Max                        |     |           | 30  | mAp-p    |
| Input Capacitance               |  |     |           | 0.3 | $\mu F$  |

**NV Series: 4 - 6W DC/DC Converters**  
**9-36V, 18-36V, 36-72V & 16-75V Inputs**  
**3.3V, 5.0V, 12V, 15V,  $\pm 5.0V$ ,  $\pm 12V$ ,  $\pm 15V$  &  $\pm 24V$  Outputs**

**Output Specifications**

All specifications apply over input voltage, output load and temperature range, unless otherwise noted.

**All Models**

| Parameter   | Conditions/Description   | Min | Nom             | Max                            | Units   |
|---|--|-----|-----------------|--------------------------------|---|
| Output Voltage Accuracy                               | Vin.Nom, 50% Io.Max  |     |                 | $\pm 1$                        | %Vo   |
| Line Regulation                                       | Vin.Min to Vin.Max, 50% Io.Max   |     |                 | $\pm 1$                        | %Vo   |
| Load Regulation                                       | Vin.Nom, Io.Min to Io.Max<br>3.3Vo<br>Other Output Voltages  |     |                 | $\pm 3.5$<br>$\pm 3.0$         | %Vo<br>%Vo  |
| Maximum Output Capacitance                            | Total, for single and dual outputs<br>3.3Vo<br>5Vo, $\pm 5Vo$<br>12Vo, $\pm 12Vo$<br>15Vo, $\pm 12Vo$<br>$\pm 24Vo$  |     |                 | 680<br>680<br>150<br>100<br>45 | $\mu F$<br>$\mu F$<br>$\mu F$<br>$\mu F$<br>$\mu F$ |
| Dynamic Regulation<br>Peak Deviation<br>Settling Time | 50-100% Io.Max load step<br>change<br>to 1% error band   |     |                 | 5.0<br>1.0                     | %Vo<br>ms   |
| Output Voltage Ripple                                 | Vin.Min to Vin.Max, Io.Min to Io<br>Max, 20MHz Bandwidth<br>3.3Vo<br>5Vo, $\pm 5Vo$<br>12Vo, $\pm 12Vo$ , $\pm 24Vo$ |     | 50<br>50<br>0.8 | 80<br>80<br>1                  | mVp-p<br>mVp-p<br>%Vo p-p                           |
| Output Current Limit Threshold                        | Output Current Limit Threshold   | 120 |                 | 200                            | %Io.Max   |
| Switching Frequency                                   | Vin.Nom, Io.Max  |     | 250             |                                | KHz   |
| Temperature Coefficient                               |  |     |                 | 0.02                           | %Vo/ $^{\circ}C$                                    |

**Typical characteristic curves for single 5V output type**

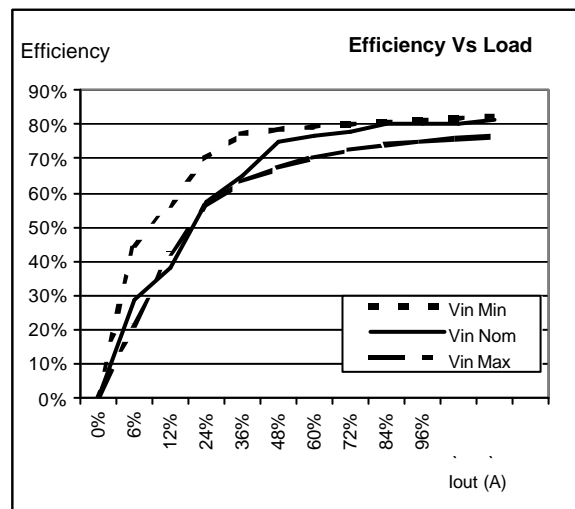
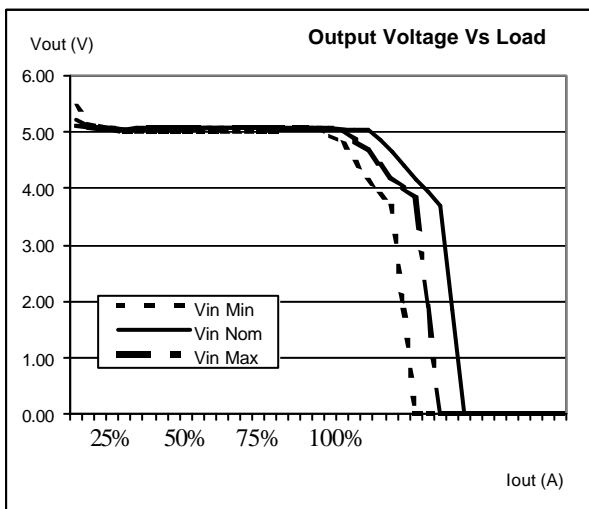

**NV Series: 4 - 6W DC/DC Converters**  
**9-36V, 18-36V, 36-72V & 16-75V Inputs**  
**3.3V, 5.0V, 12V, 15V,  $\pm 5.0V$ ,  $\pm 12V$ ,  $\pm 15V$  &  $\pm 24V$  Outputs**

### Temperature Derating Curves

The derating curves below give an indication of the output power achievable with and without forced air-cooling. However in the final application the temperature rise of the converter is also influenced by factors such as heat conduction through the leads to the PCB, orientation, the temperature of surrounding components and the input voltage. To ensure the reliability of the converter, care must be taken to guarantee that the maximum case temperature is not exceeded under any conditions. The measurement point for case temperature is specified on the mechanical drawing ( $T_c$ ).

Temperature derating for 18-36V and 36-75V input voltage ranges :

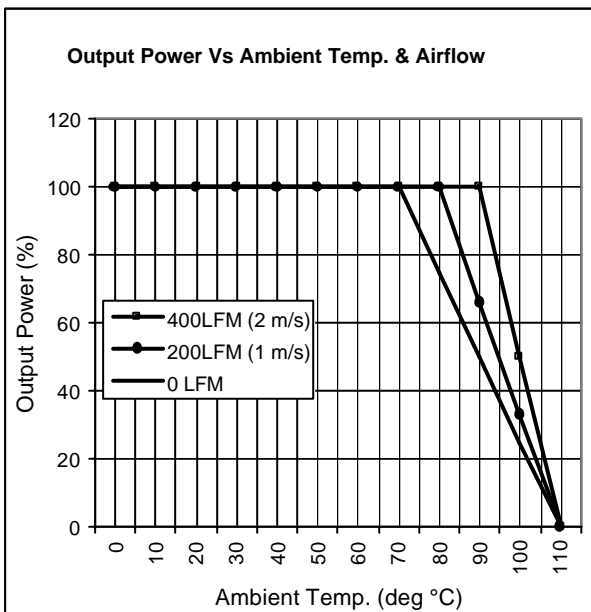

The 9-36V and 18-75V input voltage versions of this series feature a 4:1 input voltage range and can achieve operation at full power at 85°C ambient temperature with only convection cooling.

Temperature derating for 9-36V and 18-75V input voltage ranges :

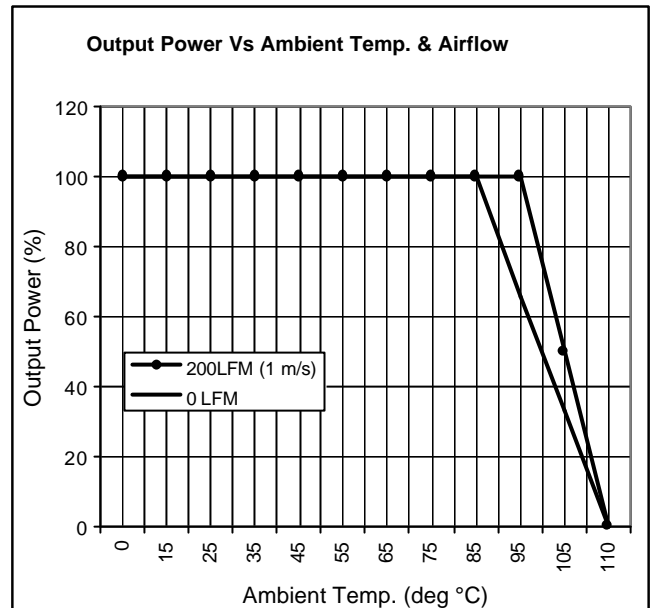

### Typical Application

This series of converters does not require any external components for proper operation. However, if the distribution of the input voltage to the converter contains significant inductance, a capacitor across the input terminals may be required to stabilize the input voltage. A minimum of 0.47 $\mu F$ , quality electrolytic / ceramic capacitor is recommended for this purpose. For output decoupling it is recommended to connect, directly across the output pins, a 0.47 $\mu F$  ceramic capacitor (for 3.3V and 5V outputs) or a 0.27 $\mu F$  ceramic capacitor (for other outputs). Care must be taken to ensure the maximum rated output capacitance for the device is not exceeded when dimensioning decoupling capacitors in the system as this could cause the unit to detect an overload and enter a 'hiccup' mode of operation.

**NV Series: 4 - 6W DC/DC Converters**  
**9-36V, 18-36V, 36-72V & 16-75V Inputs**  
**3.3V, 5.0V, 12V, 15V,  $\pm 5.0V$ ,  $\pm 12V$ ,  $\pm 15V$  &  $\pm 24V$  Outputs**

---

### Output Current Limiting

When the output is overloaded above the maximum output current rating, the voltage will start to reduce to maintain the output power to a safe level. In a condition of high overload or short-circuit where the output voltage is pulled below approximately 30% of  $V_{o.Nom}$ , the unit will enter a 'Hiccup' mode of operation. Under this condition the unit will attempt to restart, approximately every 100ms until the overload has cleared.

### Parallel Operation

Paralleling of two converters is possible by direct connection of the output voltage terminal pins. The load regulation characteristic is designed to facilitate current sharing (typically  $\pm 20\%$ ).

### Series Operation

The outputs of two units may be connected in series to achieve a higher system voltage.

### Safety Considerations

These converters feature 1500 Volt DC isolation from input to output. The input to output resistance is greater than 10M $\Omega$ . These converters are provided with Operational Insulation between input and output circuits according to EN60950 / UL1950 / CSA60950-00. Nevertheless, if the system using the converter needs to receive safety agency approval, certain rules must be followed in the design of the system. In particular, all of the creepage and clearance requirements of the end-use safety requirements must be observed. These documents include UL60950, CSA60950-00 and EN60950, although specific applications may have additional requirements.

In order for the output of the converter to be considered as SELV (Safety Extra Low Voltage) or TNV-1, according to EN60950 / UL1950 / CSA60950-00, one of the following requirements must be met in the system design:

- The converter has no internal fuse. An external fuse must be provided to protect the system from catastrophic failure. The recommended fuse values are shown below:

| Input Voltage Range | Recommended Fuse |
|---------------------|------------------|
| 36-75V              | F0.315A          |
| 18-36V              | F0.5A            |
| 9-36V               | F1.0A            |
| 18-75V              | F0.5A            |

- The user can select a lower rating fuse based upon the inrush transient and the maximum input current of the converter, which occurs at the minimum input voltage. Both input traces and the chassis ground trace (if applicable) must be capable of conducting a current of 1.5 times the value of the fuse without opening. The fuse must not be placed in the grounded input line, if any.
- If the voltage source feeding the module is SELV, the output of the converter is considered SELV and may be grounded or ungrounded.
- The circuitry of the converter may generate transients, which exceed the input voltage. Even if the input voltage is SELV (<60V) the components on the primary side of the converter may have to be considered as hazardous. A safety interlock may be needed to prevent the user from accessing the converter while operational.

**NV Series: 4 - 6W DC/DC Converters**  
**9-36V, 18-36V, 36-72V & 16-75V Inputs**  
**3.3V, 5.0V, 12V, 15V, ±5.0V, ±12V, ±15V & ±24V Outputs**

**EMC Specifications**

Conducted Noise:

The converters meet the requirements of EN55022, CISPR22 and FCC CFR title 47 part 15 Sub-part J - Conducted (conducted noise on the input terminals) without any external components. The results for this solution are displayed below.

To meet level B for the above standards it is necessary to fit a 3.3µF ceramic capacitor across the input terminals.

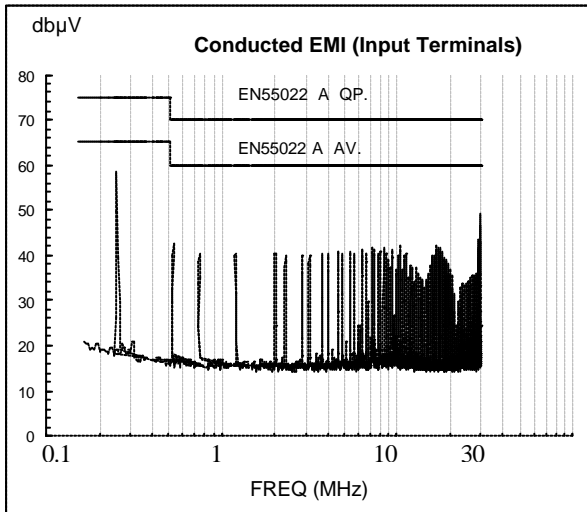

Electromagnetic Susceptibility:

| Standard                                 | Applied Stress   | Class Level | Performance Outcome * |
|--|------------------|-------------|-----------------------|
| Electrostatic Discharge<br>EN61000-4-2   | 2KV to pins      | 1           | B                     |
| Electromagnetic Field<br>EN61000-4-3     | 3V/m             | 2           | A                     |
| Electrical Fast Transient<br>EN61000-4-4 | 2000 Vp to input | 3           | B                     |
| Conducted Disturbances<br>EN61000-4-6    | 3Vrms to input   | 2           | B                     |

\* **A** denotes normal operation, no deviation from specification. **B** denotes temporary deviation from specification is possible.

**NV Series: 4 - 6W DC/DC Converters**  
**9-36V, 18-36V, 36-72V & 16-75V Inputs**  
**3.3V, 5.0V, 12V, 15V,  $\pm 5.0V$ ,  $\pm 12V$ ,  $\pm 15V$  &  $\pm 24V$  Outputs**

### Surface Mount Assembly

#### Soldering:

The following instructions must be observed when soldering the unit. Failure to observe these instructions may result in failure or significant degradation of the module performance. Power-One will not honor any warranty claims arising from failure to observe these instructions.

This product is approved for forced convection reflow soldering only.

The curves below define the maximum peak reflow temperature permissible measured on Pins 1 and 10 of the converter.

The lead-frame is constructed for a high temperature glass filled, UL94V0 flame retardant, diallyl ortho-phthalate moulding compound commonly used for packaging of electronics components. It has passed NASA outgassing tests and is certified to MIL-M-14. The coefficient of thermal expansion is equivalent to FR4.

The gull wing leads are formed to ensure optimal solder joint strength and structure. Furthermore they facilitate optical inspection (manual or automatic). The leads are formed from a 97% Cu alloy plated with Cu and Sn 90. This material is commonly used in the manufacture of integrated circuits. It has good corrosion resistance and exhibits the nobility inherent to all high copper alloys. Unlike brasses, this material is essentially immune to stress corrosion cracking. It also exhibits excellent solderability. It is readily wetted by solders and performs well in standard solderability tests. (Dip of Class II or better).

The product is manufactured with a patented process, which is fully automated, and 'in-line'. This ensures that there is no contamination or mechanical stress on the lead-frame so that the co-planarity and solderability are maintained.

The product is shipped in JEDEC trays to guarantee preservation of the co-planarity and enable fully automated assembly in the final application.

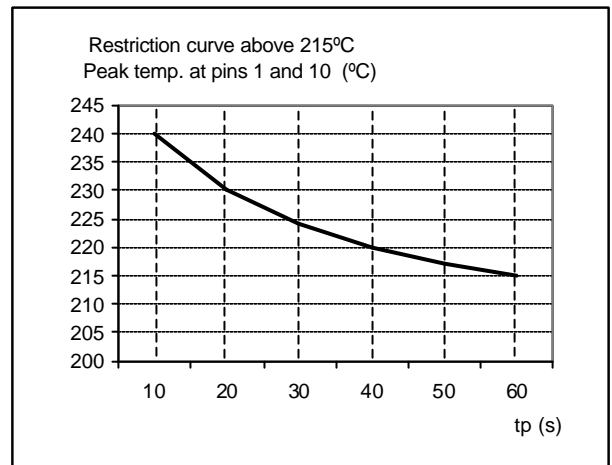
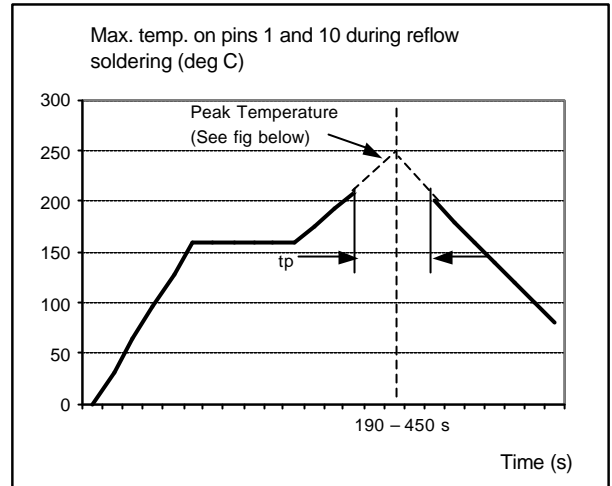

#### Pick & Place Assembly:

The product is designed with a large flat area in the center of the top surface to serve as a pick up point for automated vacuum pick and place equipment. The 'open board' construction of the unit ensures that weight is kept to a minimum. However due to the relatively large size of the component, a large nozzle (> 2.0mm, depending on vacuum pressure) is recommended for picking and placing.

The unit may also be automatically handled using 'odd-form' placement equipment, with mechanical grippers. For this type of equipment the end edges of the device, which have no leads and also feature the greatest dimensional accuracy, should be used as pick-up points.



**NV Series: 4 - 6W DC/DC Converters  
9-36V, 18-36V, 36-72V & 16-75V Inputs  
3.3V, 5.0V, 12V, 15V, ±5.0V, ±12V, ±15V & ±24V Outputs**

**Mechanical Drawing**

Note:- mm[inches]  
Tolerances: -  
**0.5-10 ±0.1**  
**10-100 ±0.2**

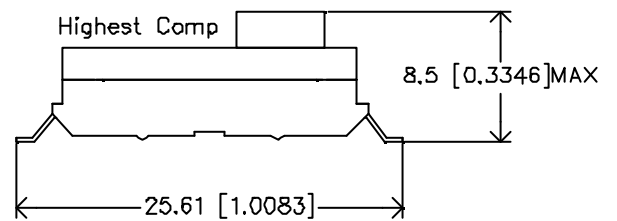
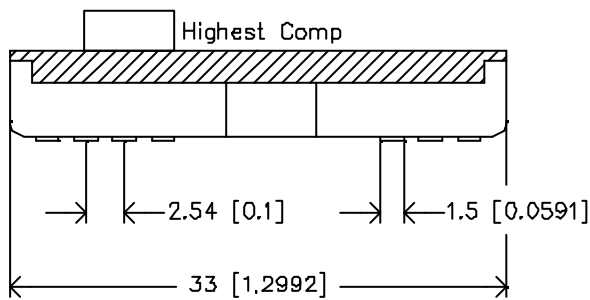
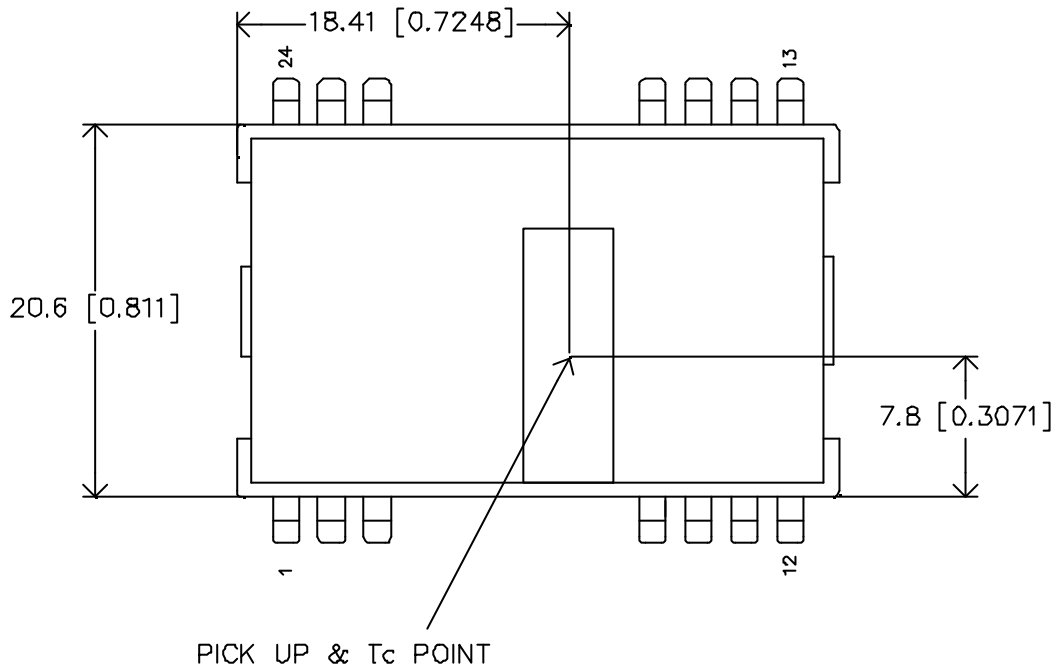

**NV Series: 4 - 6W DC/DC Converters**  
**9-36V, 18-36V, 36-72V & 16-75V Inputs**  
**3.3V, 5.0V, 12V, 15V, ±5.0V, ±12V, ±15V & ±24V Outputs**

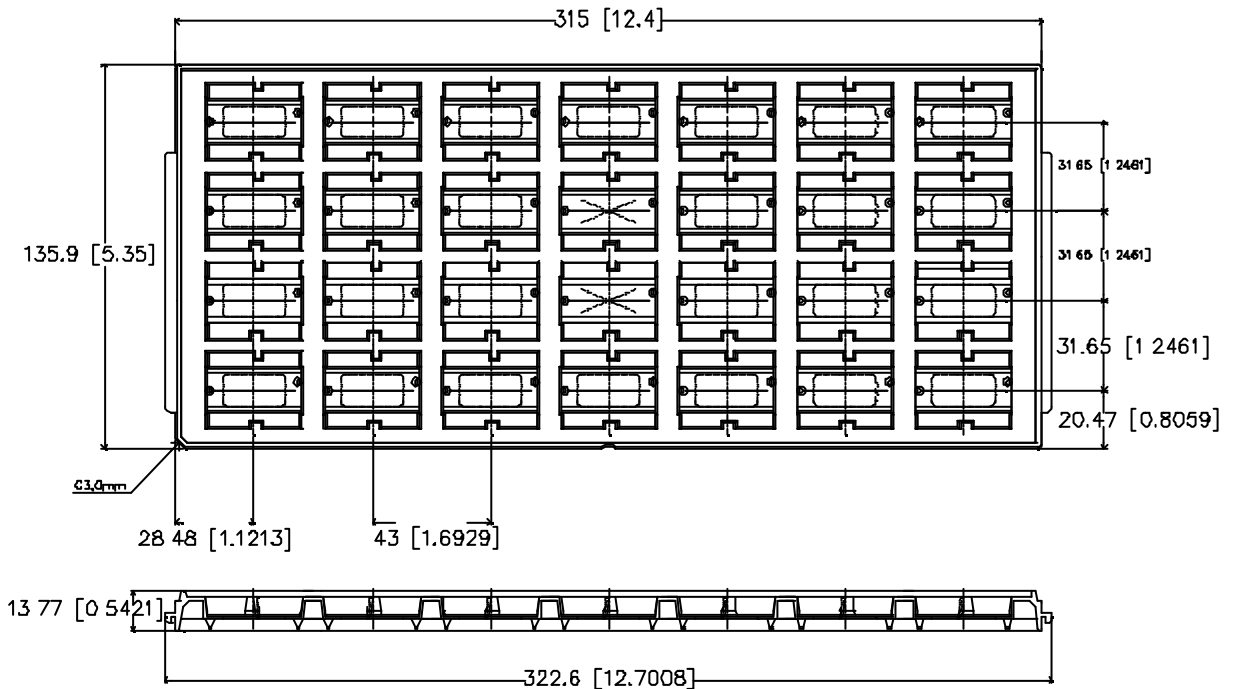
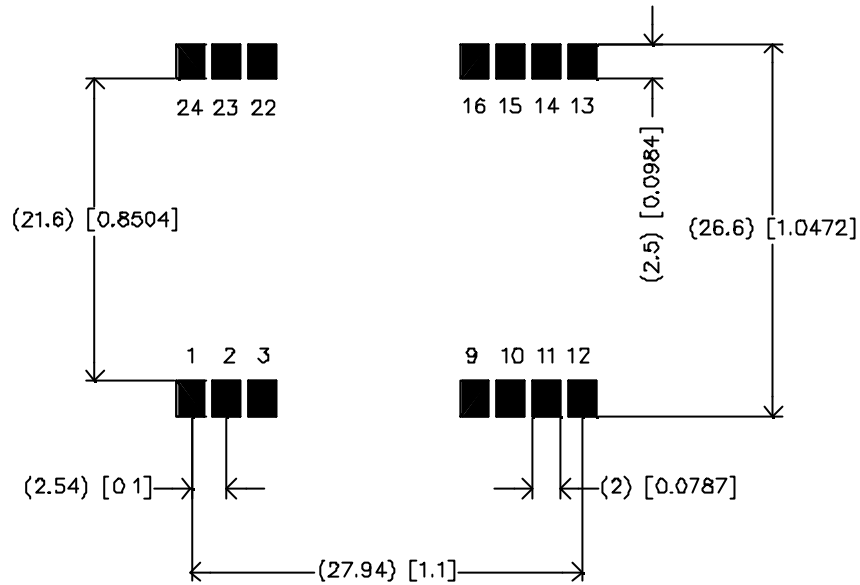

NV Series: 4 - 6W DC/DC Converters  
9-36V, 18-36V, 36-72V & 16-75V Inputs  
3.3V, 5.0V, 12V, 15V,  $\pm 5.0V$ ,  $\pm 12V$ ,  $\pm 15V$  &  $\pm 24V$  Outputs

### Pin-Out

| Pin | Function      |                    | Reference |
|-----|---------------|--------------------|-----------|
|     | Single Output | Dual Output        |           |
| 1   | +Vin          | +Vin               | Primary   |
| 2   | -Vin          | -Vin               | Primary   |
| 3   | -Vin          | -Vin               | Primary   |
| 4   | No Pin        | No Pin             | -         |
| 5   | No Pin        | No Pin             | -         |
| 6   | No Pin        | No Pin             | -         |
| 7   | No Pin        | No Pin             | -         |
| 8   | No Pin        | No Pin             | -         |
| 9   | No Connection | No Connection      | Secondary |
| 10  | No Connection | Vo Return / Common | Secondary |
| 11  | No Connection | -Vo                | Secondary |
| 12  | -Vo           | -Vo                | Secondary |
| 13  | +Vo           | -Vo                | Secondary |
| 14  | No Connection | +Vo                | Secondary |
| 15  | No Connection | +Vo                | Secondary |
| 16  | No Connection | Vo Return / Common | Secondary |
| 17  | No Pin        | No Pin             | -         |
| 18  | No Pin        | No Pin             | -         |
| 19  | No Pin        | No Pin             | -         |
| 20  | No Pin        | No Pin             | -         |
| 21  | No Pin        | No Pin             | -         |
| 22  | +Vi           | +Vi                | Primary   |
| 23  | +Vi           | +Vi                | Primary   |
| 24  | -Vi           | -Vi                | Primary   |

### Ordering Information

| Options                                      | Suffixes to part number           |
|--|-----------------------------------|
| Surface Mount Version, shipped in JEDEC Tray | Suffix "-M6".                     |
| Through hole (lead) version.                 | Consult factory for availability. |

### Notes

1. Consult factory for the complete list of available options.
2. Power-One products are not authorized for use as critical components in life support systems, equipment used in hazardous environments, or nuclear control systems without the express written consent of the President of Power-One, Inc.
3. Specifications are subject to change without notice.