

NEW

0.5mm pitch, 2.5mm above the board, high speed transmission connector for shielded FFC

FH41 Series

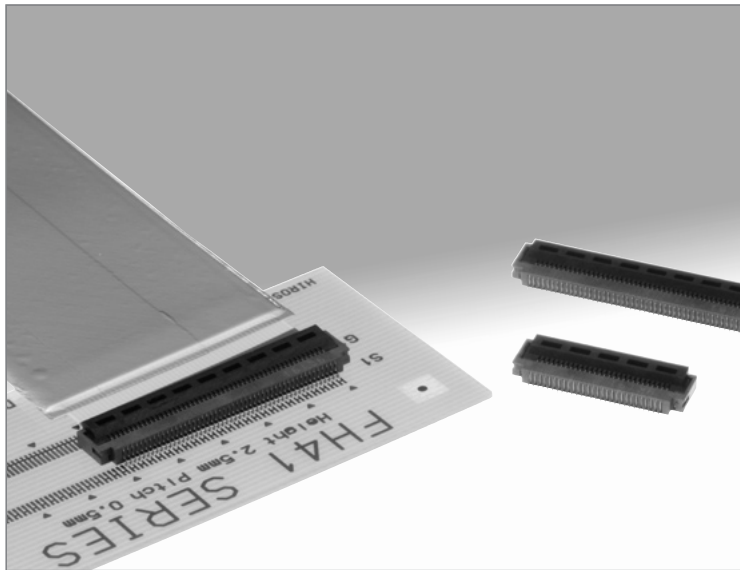

■ Features

1. Compatibility with impedance control, shield FFC

The FH41 series is equipped with a GND exclusive terminal and available for connection with impedance control, shield FFC.

2. Differential impedance $100\Omega \pm 10\%$

The FH41 series features a terminal design considering impedance control, and making high speed transmission possible.

3. Highly reliable connection, tough structure

The FH41 series follows the structure of the proven FH28 series, and achieves:

- High reliability thanks to the FFC positioning mechanism
- Reliable connection operation and no unlocking thanks to the durable structure.

4. One-finger operation of the actuator

Proven (in several other Hirose's connectors!) Flip-Lock rotating actuator assures reliable mechanical and electrical connection with FFC, confirming it with a definite tactile feel.

5. Board placement with automatic equipment

Flat upper surface and tape and reel packaging facilitate vacuum pick-up and placement. Standard reel packaging contains 2,500 connectors.

6. Halogen-free *

*As defined by IEC61249-2-21
Br-900ppm maximum, Cl-900ppm maximum,
Cl + Br combined-1,500ppm maximum

THine Electronics, Inc.
Next-generation chipset (V-by-One®HS*)
Compatible connector

* High-speed serial interface technology for image transmission



Space saving (68 pos. shown)

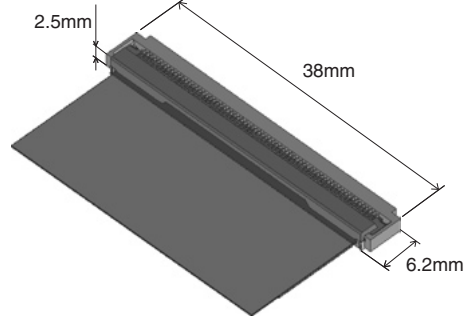

figure.1

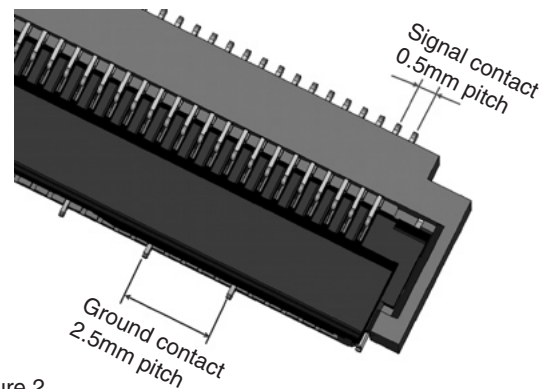

figure.2

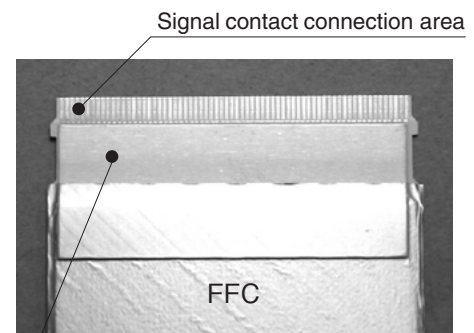

figure.3

FH41 Series 0.5mm pitch, 2.5mm above the board, high speed transmission connector for shielded FFC

■ Specifications

| | | | |
|---------|--|--|--|
| Ratings | Current rating 0.5 A(Note1) Voltage rating 50 Vrms AC | Operating temperature range: -40 to +85°C (Note 2) Operating humidity range: Relative humidity 90% max. (No condensation) | Storage temperature range: -10 to +50°C (Note 3) Storage humidity range: Relative humidity 90% max. (No condensation) |
|---------|--|--|--|

| | |
|---------------------------|---|
| Recommended FPC Thickness | 0.3 ±0.05 mm, Gold plated contact pads (GND plate:t=0.5±0.05mm,tinϕplating) |
|---------------------------|---|

| Item | Specification | Conditions |
|---------------------------------|--|---|
| 1. Insulation resistance | 500 MΩ min. | 100 V DC |
| 2. Withstanding voltage | No flashover or insulation breakdown | 150 Vrms AC / one minute |
| 3. Contact resistance | 100 mΩ max. * Including FFC conductor resistance | 1 mA, AC max (AC: 1kHz) |
| 4. Durability | Contact resistance: 100 mΩ max. No damage, cracks, or parts dislocation | 20 cycles |
| 5. Vibration | No electrical discontinuity of 1μs or longer Contact resistance: 100 mΩ max. No damage, cracks, or parts dislocation | Frequency: 10 to 55 Hz, single amplitude of 0.75mm, 10 cycles in each of the 3 directions |
| 6. Shock | No electrical discontinuity of 1μs or longer Contact resistance: 100 mΩ max. No damage, cracks, or parts dislocation | Acceleration of 981m/s ² 6 ms duration, sine halfwave, 3 cycles in each of the 3 axis |
| 7. Humidity (Steady state) | Contact resistance: 100 mΩ max. Insulation resistance: 50 MΩ min. No damage, cracks, or parts dislocation | 96 hours at 40°C and humidity of 90 to 95% |
| 8. Temperature cycle | Contact resistance: 100 mΩ max. Insulation resistance: 50 MΩ min. No damage, cracks, or parts dislocation | Temperature : -40°C → +15°C to +35°C → +85°C → +15°C to +35°C Time: 30 → 2 to 3 → 30 → 2 to 3 minutes 5 cycles |
| 9. Resistance to soldering heat | No deformation of components affecting performance | Reflow: At the recommended temperature profile Manual soldering: 350°C ±5°C for 5 seconds |

Note 1. When passing the current through all of the contacts, use 70% of the rated current.

Note 2. Includes temperature rise caused by current flow.

Note 3. The term "storage" refers to products stored for a long period prior to mounting and use.

The operating temperature and humidity range covers the non-conducting condition of installed connectors in storage, shipment or during transportation after board mounting.

Note 4. Information contained in this catalog represents general requirements for this Series.

Contact us for the drawings and specifications for a specific part number shown.

■ Materials

| Part | Material | Finish | Remarks |
|----------------|-----------------|------------------------|---------|
| Insulator | LCP | Color:Gray | UL94V-0 |
| | | Color:Black | |
| Contacts | Phosphor bronze | Gold plated | — |
| | | Pure tin reflow plated | |
| Metal fittings | Brass | | |

■ Ordering information

FH 41 - 50S - 0.5 SH (05)

① ② ③ ④ ⑤ ⑥

| | |
|----------------------------------|--|
| ① Series name : FH | ⑤ SH : SMT horizontal mounting type |
| ② Series No.: 41 | ⑥ Plating specifications :(05)...Gold plated |
| ③ Number of positions : 28 to 68 | |
| ④ Contact pitch : 0.5mm | |

■ Connector Dimensions

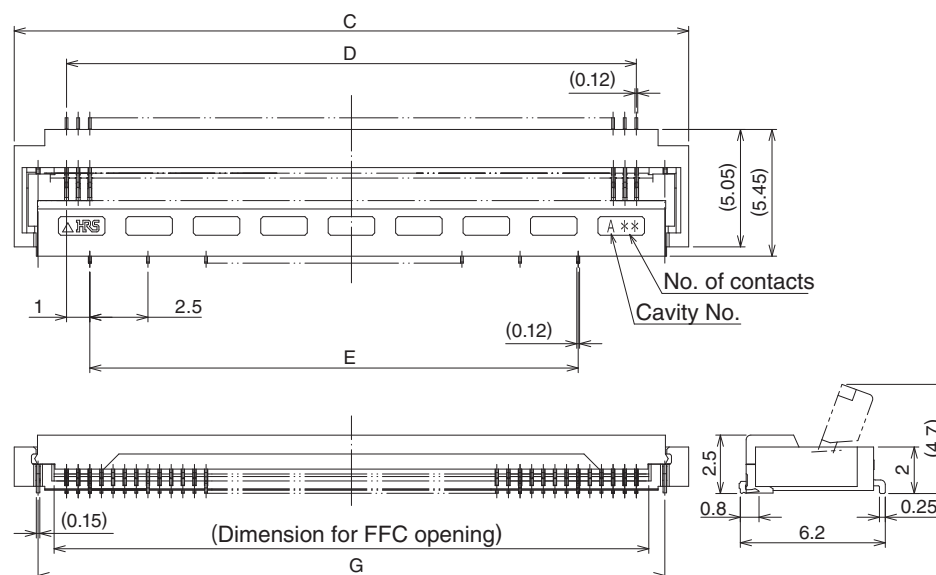

- Note 1. The coplanarity of each terminal lead within specified dimension is 0.1 mm Max.
 2. Packaged on tape and reel only. Check packaging specification.
 3. Slight variations in color of the plastic compounds do not affect form, fit or function of the connector.
 4. After reflow, the terminal plating may change color, however this does not represent a quality issue.

Unit : mm

| Part Number | CL No. | Number of contacts | No. of Contacts(GND contacts) | C | D | E | F | G |
|--------------------|---------------|--------------------|-------------------------------|----|------|------|-------|-------|
| FH41-28S-0.5SH(05) | 580-2208-1-05 | 28 | 5 | 18 | 13.5 | 10 | 14.57 | 15.95 |
| FH41-40S-0.5SH(05) | 580-2205-3-05 | 40 | 8 | 24 | 19.5 | 17.5 | 20.57 | 21.95 |
| FH41-50S-0.5SH(05) | 580-2204-0-05 | 50 | 10 | 29 | 24.5 | 22.5 | 25.57 | 26.95 |
| FH41-68S-0.5SH(05) | 580-2202-5-05 | 68 | 13 | 38 | 33.5 | 30 | 34.57 | 35.95 |

Note1. Tape and reel packaging (2,500 pieces/reel).
 Order by number of reels.

Recommended PCB mounting pattern and metal mask dimensions

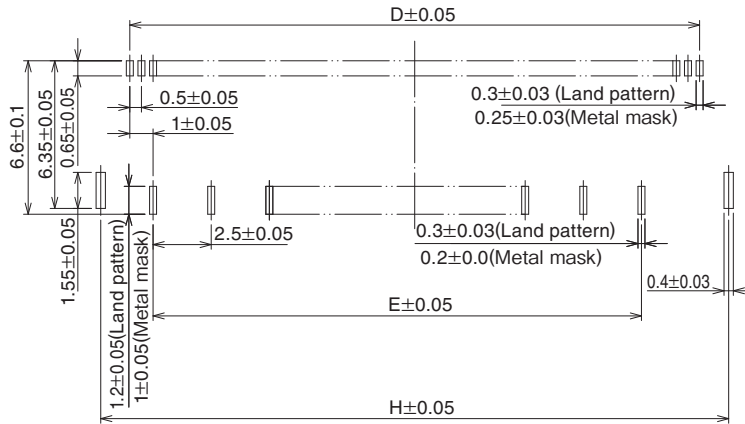

Recommended metal mask thickness $t=0.1$

Recommended FFC Dimensions

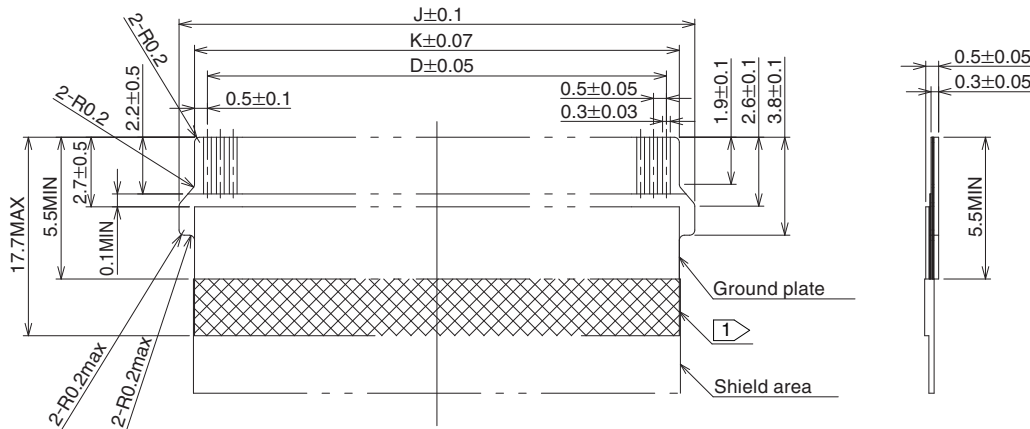

Note 1 Please overlap shield plate on ground plate.

Unit : mm

| Part Number | CL No. | Number of contacts | No. of Contacts(GND contacts) | H | J | K |
|--------------------|---------------|--------------------|-------------------------------|----|------|------|
| FH41-28S-0.5SH(05) | 580-2208-1-05 | 28 | 5 | 16 | 15.7 | 14.5 |
| FH41-40S-0.5SH(05) | 580-2205-3-05 | 40 | 8 | 22 | 21.7 | 20.5 |
| FH41-50S-0.5SH(05) | 580-2204-0-05 | 50 | 10 | 27 | 26.7 | 25.5 |
| FH41-68S-0.5SH(05) | 580-2202-5-05 | 68 | 13 | 36 | 35.7 | 34.5 |

Note1. Tape and reel packaging (2,500 pieces/reel).
 Order by number of reels.

Recommended FFC construction

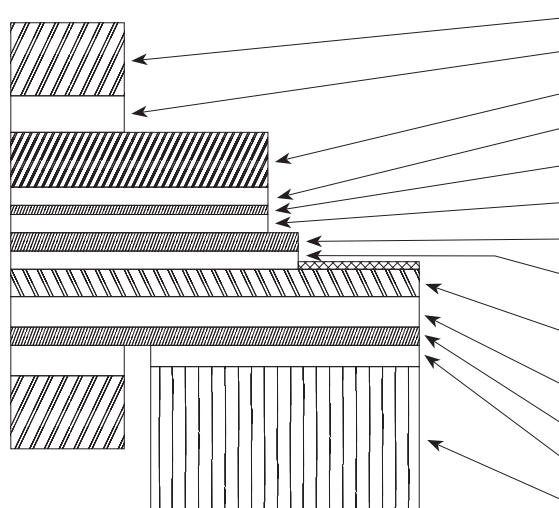

| Material Name | Material | thickness(μm) | thickness(μm) |
|---|----------------|---------------|---------------|
| Shielding Material | | | |
| Conouctiye Adhesive | Polyester Type | | |
| Copper Film (Tin Plated) | | 70 | <1 |
| Adhesive | Acrylic Type | 24 | <1 |
| Base Material | Polyester Type | 12 | <1 |
| Adhesive | Acrylic Type | 24 | <1 |
| Insulated Layer | Polyester Type | 25 | |
| Adhesive | Polyester Type | 35 | |
| Soft Copper Film (Nickel Under Plated / Gold Plated) | | 35 | 35 |
| Adhesive | Polyester Type | 35 | 35 |
| Insulated Layer | Polyester Type | 25 | 25 |
| Adhesive | Polyester Type | 30 | 30 |
| Siiffener | Polyester Type | 188 | 188 |
| Total | | 503 | 313 |

Note 1 ▷ Please overlap shield plate on ground plate.

■ Packaging Specification

● Embossed Carrier Tape Dimensions

(Tape width of 24mm max.)

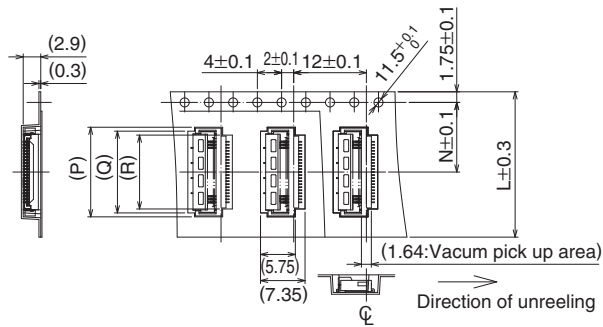

(Tape width of 32mm min.)

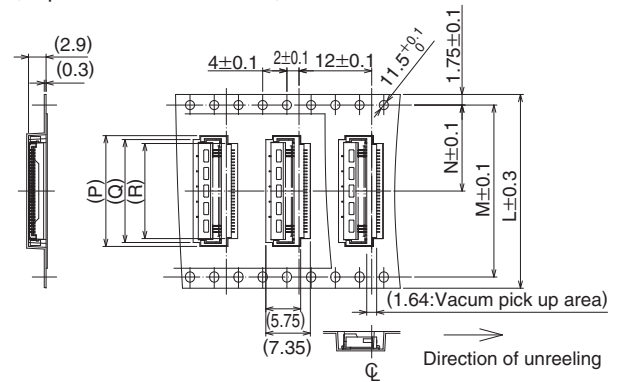

● Reel Dimensions

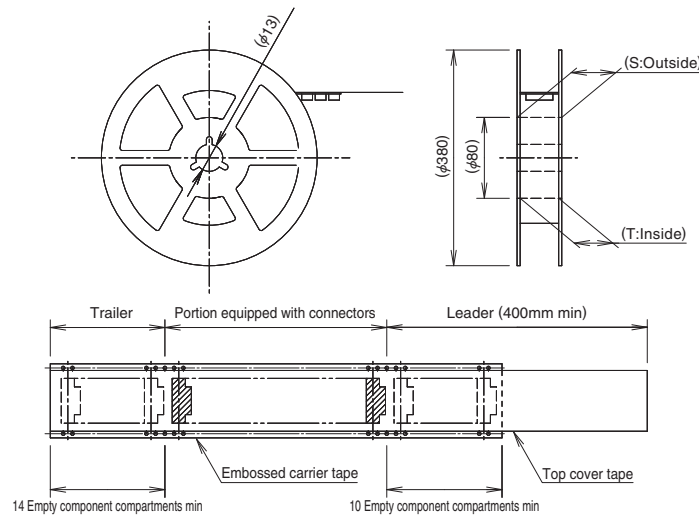

Unit : mm

| Part Number | CL No. | Number of contacts | No. of Contacts(GND contacts) | L | M | N | P | Q | R | S | T |
|--------------------|---------------|--------------------|-------------------------------|----|------|------|------|----|------|------|------|
| FH41-28S-0.5SH(05) | 580-2208-1-05 | 28 | 5 | 32 | 28.4 | 14.2 | 18.3 | 17 | 15.7 | 37.4 | 33.4 |
| FH41-40S-0.5SH(05) | 580-2205-3-05 | 40 | 8 | 44 | 40.4 | 20.2 | 24.3 | 23 | 21.7 | 49.4 | 45.4 |
| FH41-50S-0.5SH(05) | 580-2204-0-05 | 50 | 10 | 44 | 40.4 | 20.2 | 29.3 | 28 | 26.7 | 49.4 | 45.4 |
| FH41-68S-0.5SH(05) | 580-2202-5-05 | 68 | 13 | 56 | 52.4 | 26.2 | 38.3 | 37 | 35.7 | 61.4 | 57.4 |

Temperature Profile

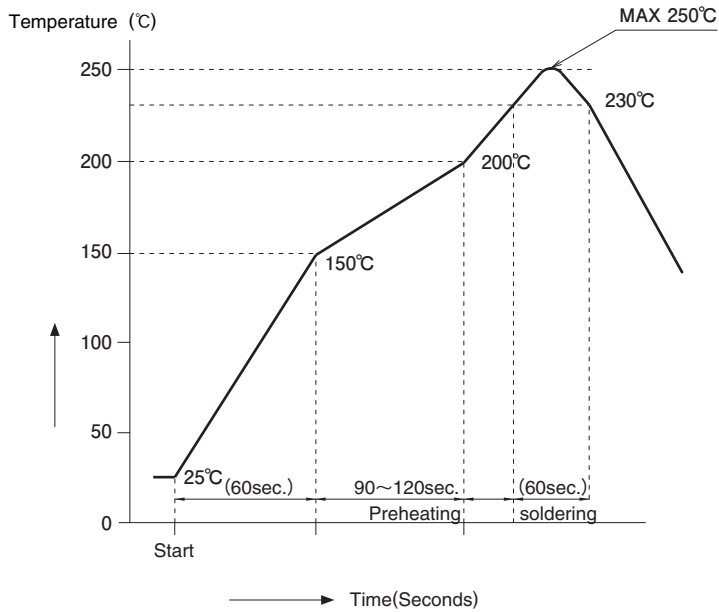

HRS test condition



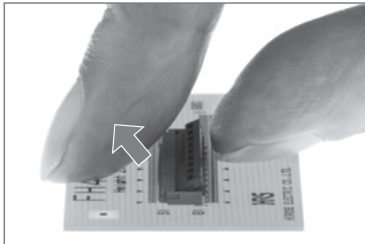
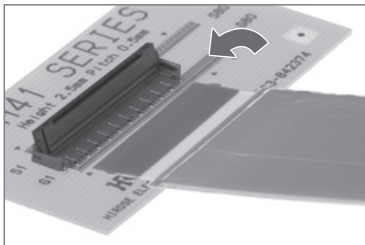
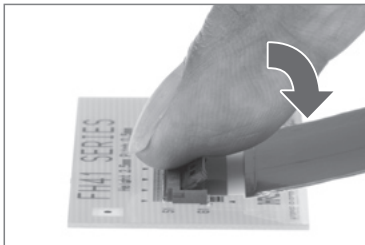
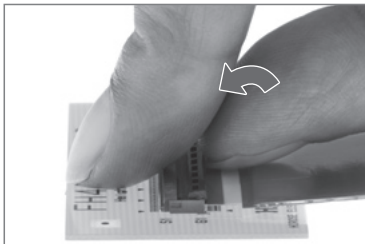
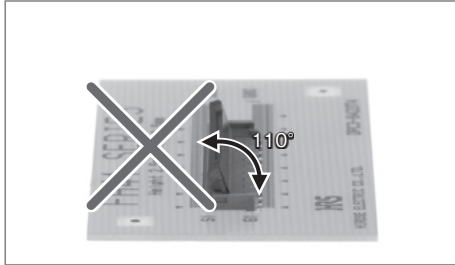
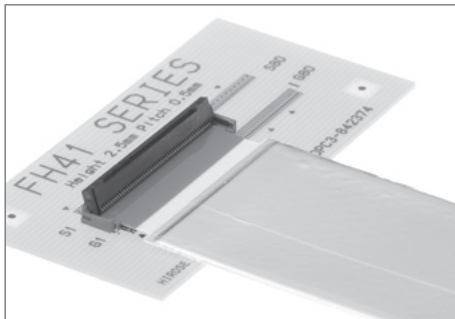
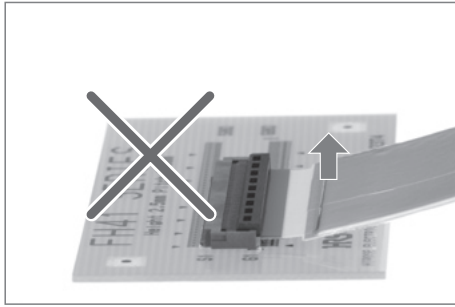

| | |
|--------------------|---|
| Solder method | :Reflow, IR/hot air |
| Environment | :Room air |
| Solder composition | :Paste, 96.5%Sn/3.0%Ag/0.5%Cu (Senju Metal Industry, Co., Ltd.'s Part Number:M705-221CM5-32-10.5) |
| Test board | :Glass epoxy 30mm×60mm×0.8mm thick |
| Land dimensions | :0.3mm×0.65mm, 0.3mm×1.2mm |
| Metal mask | :0.25×0.65, 0.2×0.1mm thick |

The temperature profiles shown are based on the above conditions. In individual applications the actual temperature may vary, depending on solder paste type, volume / thickness and board size / thickness. Consult your solder paste and equipment manufacturer for specific recommendations.

■Operation and Precautions

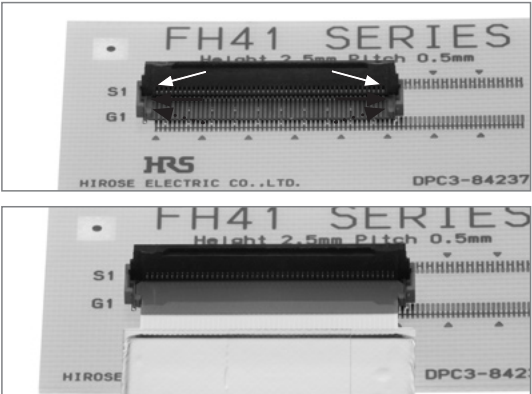
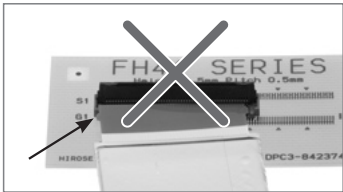
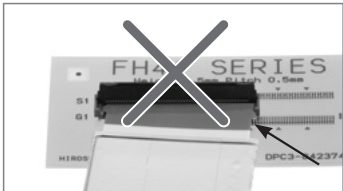
| Operation | Precautions |
|--|---|
| <p>1.FFC insertion procedure. Connector installed on the board.</p> <p>① Lift up the actuator. Use thumb or index finger</p>  <p>② Fully insert the FFC in the connector parallel to mounting surface, with the exposed conductive traces facing down.</p>  <p>③ Rotate down the actuator until firmly closed. It is critical that the inserted FFC is not moved and remains fully inserted.</p>  <p>2.FFC removal Fully open the actuator. Carefully withdraw the FFC exercising caution not to deform or damage it.</p>  | <p>① Do not force the actuator to open beyond its fully open position. Do not use any type of tool to open the actuator.</p>  <p>② Do not forcefully bend the FFC upward. Consult FFC manufacturer for the recommended bend radiuses.</p>  <p>③ For connectors with multiple contacts, such as 80 pos. rotate down the actuator pushing at both ends.</p>  |
| | <p>④ Load to FFC Be very careful not to apply any force to the connector directly after inserting FFC. Otherwise, the connector may become unlocked or the FFC may break. In particular, design the FFC layout with care not to bend it sharply upward in a vertical direction near the insertion opening. Fix the FFC when loads are applied to it continuously.</p> |

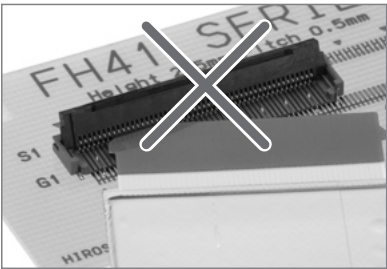
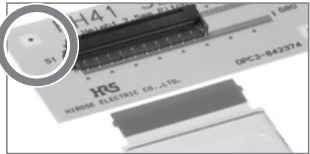
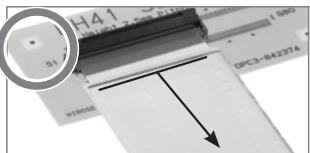
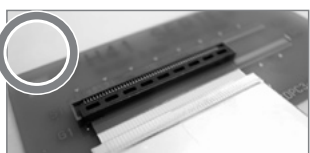
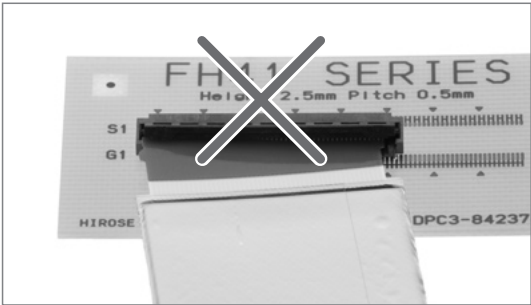
■Precautions (mating/un-mating FFC with the retention tabs)

| Operation | Precautions |
|--|--|
| <p>1.How to insert</p> <p>Insert the cable into the interspace between the mold walls (→) at both ends of entrance where the connector is inserted and the guide walls (⇨) at both ends of interior connector so the cable tabs are properly located.</p>  | <p>② Avoid "ride on"</p> <p>Avoid insertion so the cables ride on any guide. Be sure NOT to close the actuator as the cables ride on any guide. It may cause conduction failure.</p> <p>Ride on a left guide</p>  <p>Ride on a right guide</p>  <p>Correct insertion</p>  |
| <p>2.Precautions when mating /un-mating</p> <p>① Avoid insertion in diagonal direction. Do not insert the cable in diagonal direction. A part of the connector may touches the contacts resulting in deformation of the contacts.</p>  <p>Insert the cable straight into the connector and hook the cable tabs with the guide.</p> <p>After insertion, slightly pull the cables to make sure the cable tabs are firmly secured. No removal of the cable means correct insertion.</p> <p>① Insert the cable straight and obliquely from above.</p>  <p>② Slightly pull the cable to make sure the tabs are firmly secured.</p>  <p>③ Close the actuator.</p>  | <p>Do not close the actuator as the cables ride on.</p>  <p>In the event it is locked as the cables ride on a guide, absolutely avoid moving the cable. In this case, open the actuator and re-insert the cable as instructed in "1.How to insert"</p> <p>Do not move the cables back and forth and around as the cables ride on the guide when the actuator is closed.</p>  |