

Data sheet | Item number: 858-314

Relay module; Nominal input voltage: 24 VDC; 4 changeover contacts;
 Limiting continuous current: 5 A; with gold contacts; with manual operation;
 Red status indicator; Module width: 31 mm; 1,50 mm²

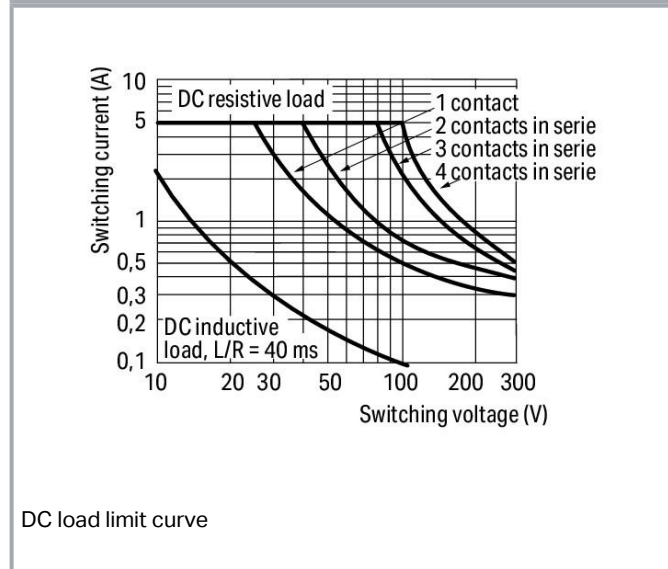

www.wago.com/858-314

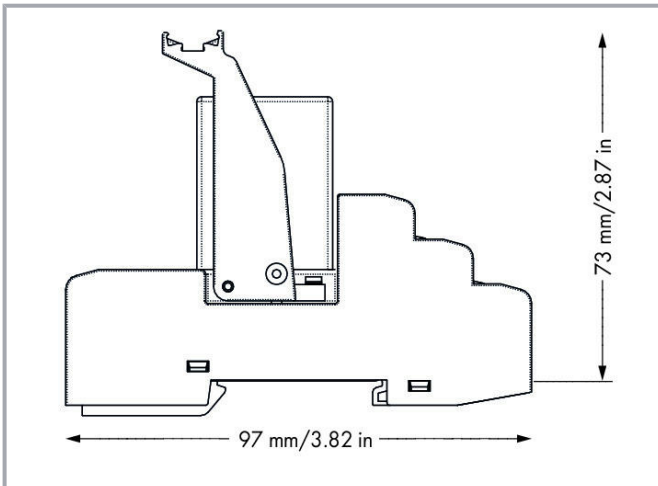
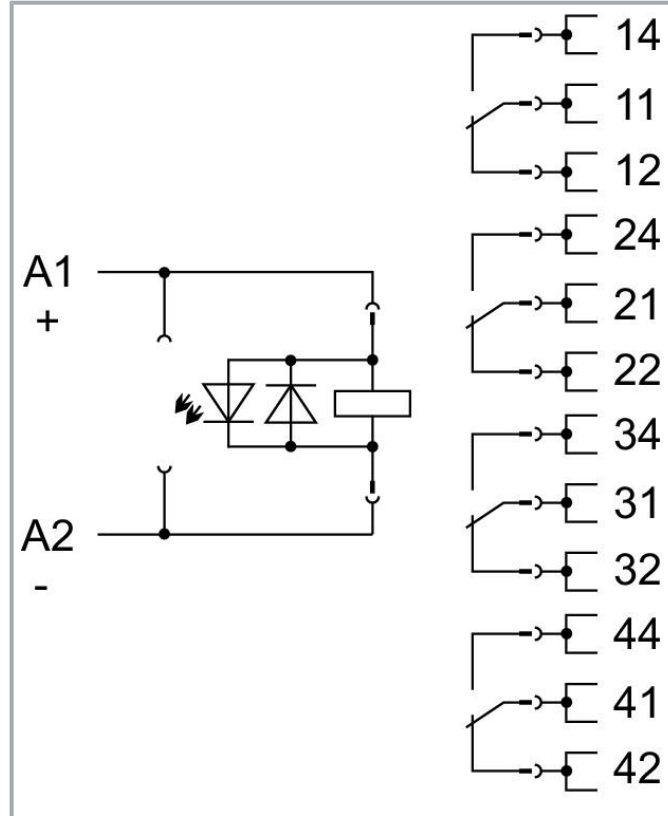
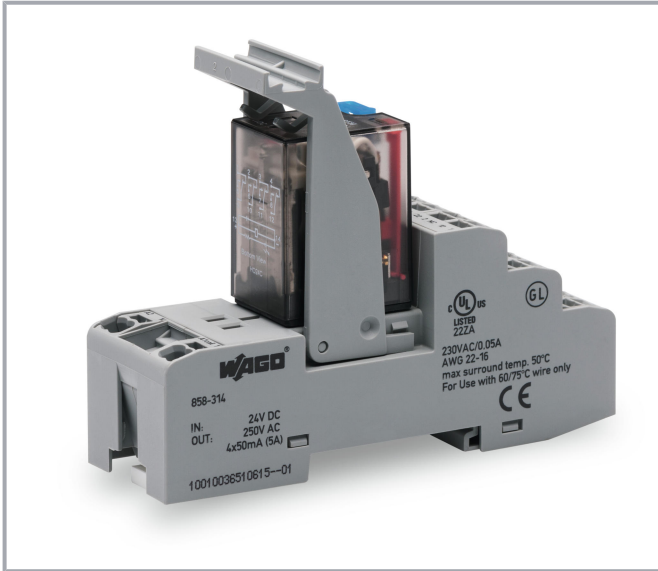

DC load limit curve

Subject to changes. Please also observe the further product documentation!

WAGO Kontakttechnik GmbH & Co. KG
 Hansastr. 27
 32423 Minden
 Phone: +49571 887-0 | Fax: +49571 887-169
 Email: info.de@wago.com | Web: www.wago.com

Do you have any questions about our products?
 We are always happy to take your call at +49 (571) 887-44222.

**Data****Notes**

Note

To prevent damaging the gold layer, 30 VDC switching voltages and 50 mA currents must not be exceeded. Higher switching power eventually evaporates the gold layer. The resulting deposits in the housing may reduce service life.

Technical data**Control circuit**

Nominal input voltage U_N	DC 24 V
Input voltage range	-20 ... +10 %
Nominal input current at U_N	36.9 mA

Load circuit

Number of changeover/switchover contacts	4
Contact material (relay)	AgCe + Au
Limiting continuous current	5 A
Inrush current (resistive) (max.)	(AC) 15 A / 4 s
Switching voltage (max.)	AC 250 V
Switching power (resistive) (max.)	AC 1250 VA; DC (see load limit curve)
Switching capacity	AC-15: 1 A / AC 240 V; DC-13: 2 A / DC 24 V
Recommended minimum load	5 V / 1 mA / 50 mW
Pull-in time (typ.)	25 ms
Drop-out time (typ.)	25 ms
Bounce time (typ.)	4 ms
Electrical life (NO; resistive load; 23 °C)	100 x 10 ³ switching operations
Mechanical life	20 x 10 ⁶ switching operations

Signaling

Status indicator	Red LED Mechanical
------------------	-----------------------

Subject to changes. Please also observe the further product documentation!

Safety and protection

Rated voltage	300 V
Rated surge voltage	2.5 kV
Pollution degree	2
Dielectric strength, control/load circuit (AC, 1 min)	1.5 kVrms
Dielectric strength, open contact (AC, 1 min)	1 kVrms
Dielectric strength, load/load circuit (AC, 1 min)	1.5 kVrms
Insulation type (control/load circuit)	Basic insulation
Insulation type (load/load circuit)	Basic insulation
Insulation type (adjacent devices)	Reinforced insulation (safe isolation)
Protection type	IP20

Connection data

Connection technology	Push-in CAGE CLAMP®
Solid conductor	0.34 ... 1.5 mm ² / 22 ... 16 AWG
Fine-stranded conductor	0.34 ... 1.5 mm ² / 22 ... 16 AWG
Strip length	9 ... 10 mm / 0.35 ... 0.39 inch
Note (conductor cross-section)	2 x 0.34 ... 2 x 1.5 mm ² / 1 x 2.5 mm ² / 2 x 22 ... 2 x 16 AWG

Physical data

Width	31 mm / 1.22 inch
Height	97 mm / 3.819 inch
Depth from upper edge of DIN-rail	73 mm / 2.874 inch

Mechanical data

Mounting type	DIN-35 rail
Mounting position	horizontal (standing/lying); vertical

Material data

Fire load	1.226 MJ
Weight	97.5 g

Environmental requirements

Surrounding air temperature (operation at U_N)	-25 ... 70 °C
Surrounding air (operating) temperature for UL	-25 ... 50 °C

Subject to changes. Please also observe the further product documentation!

Surrounding air temperature (storage)	-40 ... 70 °C
Processing temperature	-25 ... +50 °C
Relative humidity	5 ... 85 %
Operating altitude (max.)	2000 m

Standards and specifications

Standards/Specifications	EN 61010-2-201 EN 61810-1 EN 61373 GL UL 508 (max. 50 °C)
--------------------------	---

Basic relay



WAGO Basic Relay	858-152
------------------	---------

Commercial data

Product Group	6 (Interface Electronics)
PU (SPU)	5 Stück
Packaging type	box
Country of origin	DE
GTIN	4055143567893
Customs tariff number	85364900990

Approvals / Certificates

Ship Approvals

Logo	Approval	Additional Approval Text	Certificate name
	DNV GL Det Norske Veritas, Germanischer Lloyd	-	TAA00001D1
	NK Nippon Kaiji Kyokai	-	TA17255M
	PRS Polski Rejestr Statków	-	TE/2186 /880590/18



UL-Approvals

Certificate















Subject to changes. Please also observe the further product documentation!

Logo	Approval	Additional Approval Text	name
	UL UL International Netherlands B.V. (ORDINARY LOCATIONS)	UL 508	E175199 Sec.6

Optional accessories

Ferrule			
	Item no.: 216-241 Ferrule; Sleeve for 0.5 mm ² / 20 AWG; insulated; electro-tin plated; electrolytic copper; gastight crimped; acc. to DIN 46228, Part 4/09.90; white		www.wago.com/216-241
	Item no.: 216-242 Ferrule; Sleeve for 0.75 mm ² / 18 AWG; insulated; electro-tin plated; electrolytic copper; gastight crimped; acc. to DIN 46228, Part 4/09.90; gray		www.wago.com/216-242
	Item no.: 216-243 Ferrule; Sleeve for 1 mm ² / AWG 18; insulated; electro-tin plated; electrolytic copper; gastight crimped; acc. to DIN 46228, Part 4/09.90; red		www.wago.com/216-243
	Item no.: 216-244 Ferrule; Sleeve for 1.5 mm ² / AWG 16; insulated; electro-tin plated; electrolytic copper; gastight crimped; acc. to DIN 46228, Part 4/09.90; black		www.wago.com/216-244
Indicators			
	Item no.: 788-120 Accessories for relay modules; Operation status indicator: red; Nominal operating voltage: 24 VDC		www.wago.com/788-120
Jumpers			
	Item no.: 858-402 Jumper		www.wago.com/858-402
Mounting			
	Item no.: 858-110 Mounting bracket		www.wago.com/858-110
Tool			
	Item no.: 210-719 Operating tool; Blade: 2.5 x 0.4 mm; with a partially insulated shaft		www.wago.com/210-719
Marking accessories			
	Marking strip		

Subject to changes. Please also observe the further product documentation!

	Item no.: 2009-110 Marking strips; for Smart Printer; on reel; not stretchable; plain; snap-on type; white	www.wago.com/2009-110
Marking device		
	Item no.: 210-110 Fiber-tip pen	www.wago.com/210-110
Double marker carrier		
	Item no.: 209-128 Adaptor; gray	www.wago.com/209-128
Protective marker cover		
	Item no.: 209-184 Protection cover; transparent	www.wago.com/209-184
Marker		
	Item no.: 2009-115 WMB-Inline; for Smart Printer; 1500 pieces on roll; stretchable 5 - 5.2 mm; plain; snap-on type; white	www.wago.com/2009-115
	Item no.: 209-183 Marker card; white	www.wago.com/209-183
	Item no.: 793-501 WMB marking card; as card; not stretchable; plain; snap-on type; white	www.wago.com/793-501
	Item no.: 793-502 WMB marking card; as card; MARKED; 1 ... 10 (10x); not stretchable; Horizontal marking; snap-on type; white	www.wago.com/793-502
	Item no.: 793-503 WMB marking card; as card; MARKED; 11 ... 20 (10x); not stretchable; Horizontal marking; snap-on type; white	www.wago.com/793-503
	Item no.: 793-504 WMB marking card; as card; MARKED; 21 ... 30 (10x); not stretchable; Horizontal marking; snap-on type; white	www.wago.com/793-504
	Item no.: 793-505 WMB marking card; as card; MARKED; 31 ... 40 (10x); not stretchable; Horizontal marking; snap-on type; white	www.wago.com/793-505
	Item no.: 793-506 WMB marking card; as card; MARKED; 41 ... 50 (10x); not stretchable; Horizontal marking; snap-on type; white	www.wago.com/793-506
	Item no.: 793-566 WMB marking card; as card; MARKED; 1 ... 50 (2x); not stretchable; Horizontal marking; snap-on type; white	www.wago.com/793-566
	Item no.: 793-5501 WMB marking card; as card; for terminal block width 5 - 17.5 mm; stretchable 5 - 5.2 mm; plain; snap-on type; white	www.wago.com/793-5501

Subject to changes. Please also observe the further product documentation!

Group marker carrier



Item no.: 209-145
Group marker carrier; white

www.wago.com/209-145



Item no.: 249-105
Group marker carrier; gray

www.wago.com/249-105

Downloads

Documentation

Bid Text

858-314 docx - Datei	2019. 2. 20.	docx 17.5 kB	Download
858-314 X81 - Datei	2019. 2. 19.	xml 5.2 kB	Download

Instruction Leaflet

Stecksocket für Elementarrelais		pdf 2.6 MB	Download
---------------------------------	--	---------------	----------

Additional Information

Disposal; Electrical and electronic equipment, Packaging	V 1.0.0	pdf 265.8 kB	Download
--	---------	-----------------	----------

CAD/CAE-Data

CAD data

2D/3D Models 858-314		URL	Download
----------------------	--	-----	----------

CAE data

EPLAN Data Portal 858-314		URL	Download
---------------------------	--	-----	----------

ZUKEN Portal 858-314		URL	Download
----------------------	--	-----	----------

WSCAD Universe 858-314		URL	Download
------------------------	--	-----	----------

Subject to changes. Please also observe the further product documentation!

Environmental Product Compliance

Compliance Search

Environmental Product Compliance 858-314

URL

Download

Relay module; Nominal input voltage: 24 VDC; 4 changeover contacts; Limiting continuous current: 5 A; with gold contacts; with manual operation; Red status indicator; Module width: 31 mm; 1,50 mm²

Installation Notes

Commoning

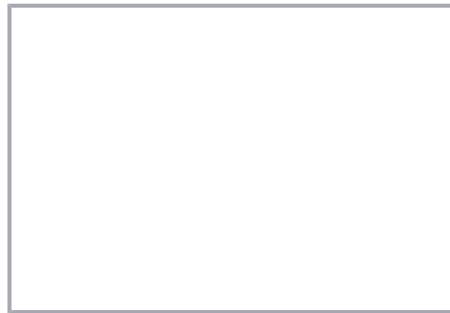

Removing a jumper via screwdriver.

Marking



Marking using WMB Multi markers and group marker carriers.

Subject to changes. Please also observe the further product documentation!