

ELM854xx CMOS Dual operational amplifier

http://www.elm-tech.com

■ General description

ELM854xx is low power consumption CMOS dual OP-AMP with wide range of common mode signal input voltage and push-pull output stage. With 1.2V single power supply, ELM854xx makes it easy to design power circuit. ELM854xx is suitable for circuit of portable equipments which require low power consumption or single power.

■ Features

- Single supply operation
- Low voltage operation : $1.2V \leq V_{dd} \leq 6.0V$
- Low current consumption : Typ. $300\mu A$
($V_{dd}=3.0V$, 2Amp. units total)
- Common-mode input voltage range : V_{ss} to $V_{dd}-0.3V$ ($V_{dd}=1.5V$)
 V_{ss} to $V_{dd}-0.1V$ ($V_{dd}=3.0V$)
- Output stage : Push-pull
- Unity gain bandwidth : Typ. $1MHz$ ($V_{dd}=1.5V$)
Typ. $0.8MHz$ ($V_{dd}=3.0V$)
- Package : SOP-8, TSSOP-8

■ Application

- Battery-operated devices
- Micropower signal process
- Low voltage analog circuit

■ Maximum absolute ratings

Parameter	Symbol	Limit	Unit
Power supply voltage	V _{dd}	10	V
Input voltage	V _{in}	$V_{ss}-0.3$ to $V_{dd}+0.3$	V
Differential input voltage	V _{id}	$V_{dd}-V_{ss}$	V
Output voltage	V _{out}	$V_{ss}-0.3$ to $V_{dd}+0.3$	V
Output short circuit		Continuous	Sec.
Power dissipation	P _d	300	mW
Operating temperature	T _{op}	-20 to +70	°C
Storage temperature	T _{stg}	-55 to +125	°C

■ Selection guide

ELM854xx-x

Symbol		
a, b	Package	AA: SOP-8 BB: TSSOP-8
c	Taping direction	S: Refer to PKG file N: Refer to PKG file

ELM854 x x - x
 $\begin{matrix} \uparrow & \uparrow & \uparrow \\ a & b & c \end{matrix}$

ELM854xx CMOS Dual operational amplifier

<http://www.elm-tech.com>

■ Pin configuration

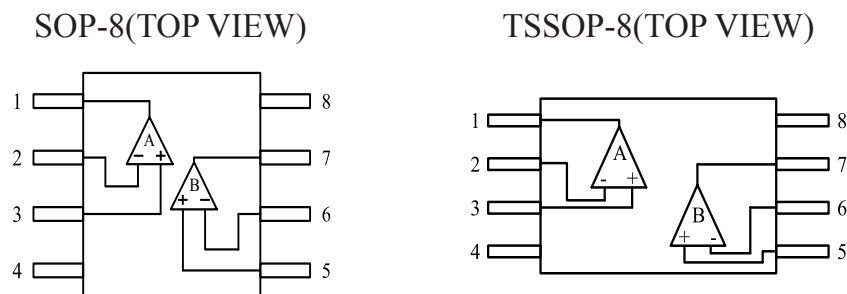

Pin No.	Pin name	Pin No.	Pin name
1	OUTA	5	IN+B
2	IN-A	6	IN-B
3	IN+A	7	OUTB
4	VSS	8	VDD

■ Standard circuit

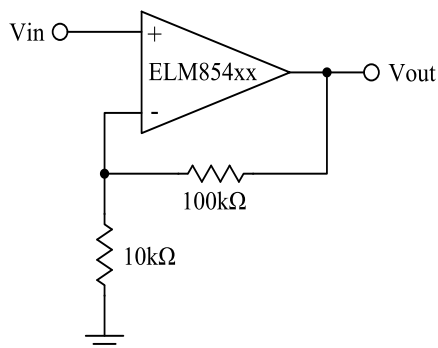

■ Electrical characteristics (Vdd=1.5V)

Vss=0V, Top=25°C

Parameter	Symbol	Condition	Min.	Typ.	Max.	Unit
Input offset voltage	Vio	Vin+=Vdd/2, Unity gain follower			±6	mV
Input bias current	Iib				1.0	nA
Common-mode input voltage range	Vcmr	For CMRR≥45dB	0.00		1.20	V
Maximum output voltage swing	Vouts	Vid=100mV, RL=10kΩ to Vss	1.40			V
Large-signal voltage gain	Avd	RL=10kΩ to Vss		85		dB
Common-mode rejection ratio	CMRR	RL=10kΩ to Vss		65		dB
Supply voltage rejection ratio	PSRR	RL=10kΩ to Vss Vdd=1.35V to 6.0V		85		dB
Current consumption	Iss	Vin+=Vdd/2, Unity gain follower		270	400	μA
Unity gain bandwidth	GBW			1.0		MHz
Slew rate	SR	RL=100kΩ, CL=20pF	0.55	0.85		V/μs

ELM854xx CMOS Dual operational amplifier

<http://www.elm-tech.com>

■Electrical characteristics (V_{dd}=3.0V)

V_{ss}=0V, T_{op}=25°C

Parameter	Symbol	Condition	Min.	Typ.	Max.	Unit
Input offset voltage	V _{io}	V _{in+} =V _{dd} /2, Unity gain follower			±6	mV
Input bias current	I _{ib}				1.0	nA
Common-mode input voltage range	V _{cmr}	For CMRR≥45dB	0.00		2.90	V
Maximum output voltage swing	V _{outs}	V _{id} =100mV, R _L =10kΩ to V _{ss}	2.90			V
Large-signal voltage gain	A _{vd}	R _L =10kΩ to V _{ss}		90		dB
Common-mode rejection ratio	CMRR	R _L =10kΩ to V _{ss}		70		dB
Supply voltage rejection ratio	PSRR	R _L =10kΩ to V _{ss} V _{dd} =2.7V to 6.0V		90		dB
Current consumption	I _{ss}	V _{in+} =V _{dd} /2, Unity gain follower		300	450	μA
Unity gain bandwidth	GBW			0.8		MHz
Slew rate	SR	R _L =100kΩ, C _L =20pF	0.40	0.65		V/μs

■Marking

SOP-8

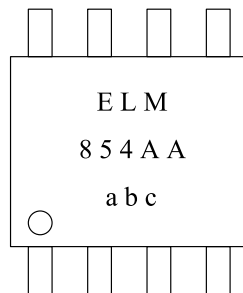

TSSOP-8

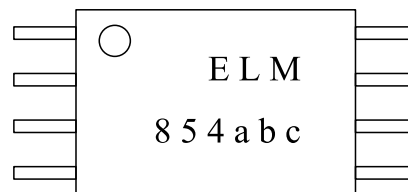

Symbol	Mark	Content
a	0 to 9	Last numeral of A.D.
b	A to M (excepted I)	Assembly month
c	0 to 9	Lot No.

ELM854xx CMOS Dual operational amplifier

<http://www.elm-tech.com>

■Note

1) Common-mode input voltage range

ELM854xx common mode input voltage range is fixed under the condition of $CMRR \geq 45\text{dB}$; ELM854xx is able to accept the input above its specification if the degradation of $CMRR$ is not considered. Even if the input voltage exceeds either positive or negative power voltage, troubles such as reverse of output will not occur.

As maximum absolute rating, the input voltage is possible within $(V_{ss}-0.3)\text{V}$ to $(V_{dd}+0.3)\text{V}$.

2) Operation from single power source

ELM854xx is designed to be most suitable for single power source; therefore, ELM854xx is able to share power supply with logic circuit one. Meanwhile, ELM832BW can also operate from double power sources. To protect power supplies of ELM854xx and logic circuit from noise, please separate wire from power supply and use decoupling (bypass) capacitor. Using the capacitor can improve PSRR characteristics, especially on 10kHz to 100kHz or more.

3) Feedback

When OP-AMP circuit is used with feedback resistor, oscillation may happen in the circuit with loop-gain like unity gain follower.

a) When large feedback resistance is used, the phase margin is decreased by its combination with the parasitic capacitance of the input part of OP-AMP. In this situation, please connect small capacitor parallelly with feedback resistor as shown in fig-1.

b) For capacitive load, external resistor in series connection will be effective as shown in fig-2. ($R=300$ to 500Ω)

c) Being used as an unity gain follow, ELM854xx is able to drive capacitive load of 100pF directly without oscillation.

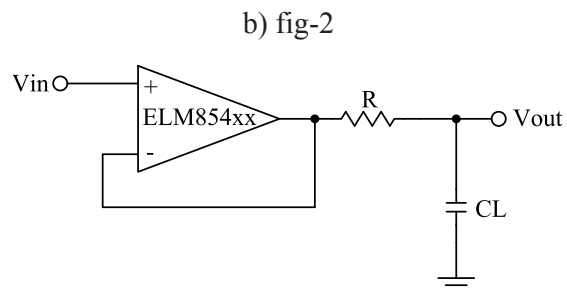
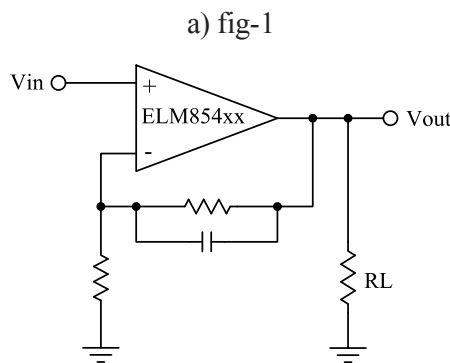

4) Unused Amplifier

Two amplifiers will consume power even if only one amplifier is used.

In order to minimize power consumption by the unused amplifier, ELM recommends to connect this amplifier as voltage follower circuit and the input terminal (IN+) to V_{dd} .

ELM854xx CMOS Dual operational amplifier

<http://www.elm-tech.com>

■ Typical characteristics

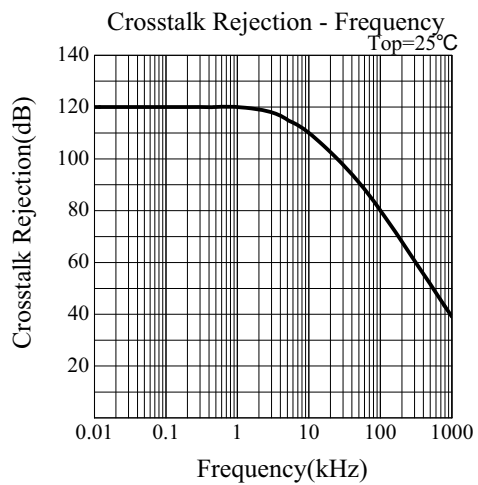
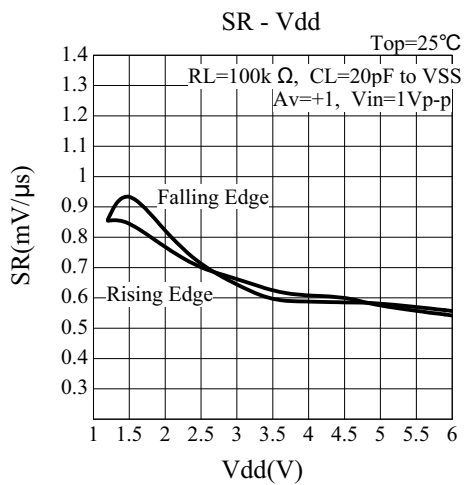
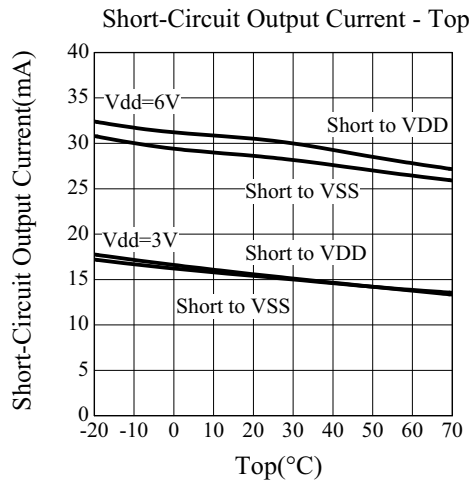
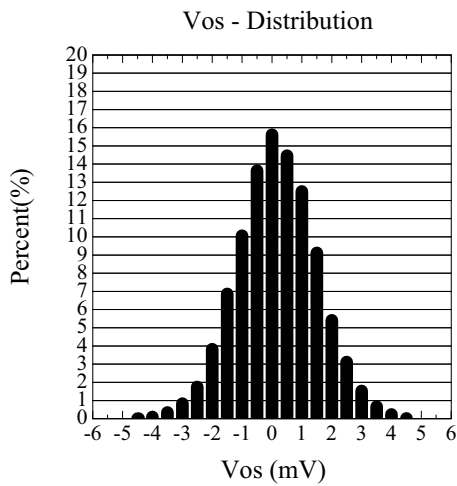
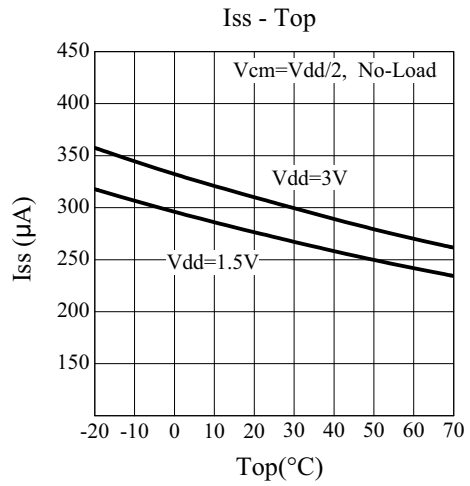
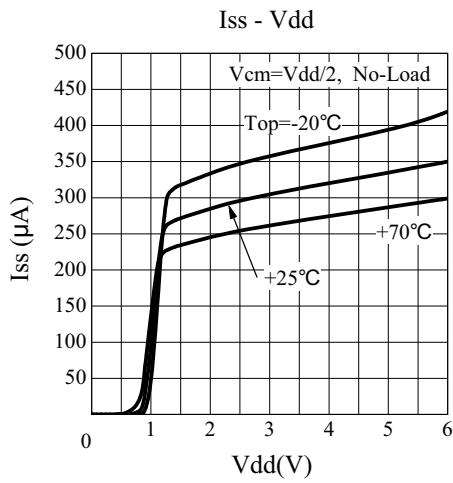

ELM854xx CMOS Dual operational amplifier

<http://www.elm-tech.com>

■ 1.5V Performance

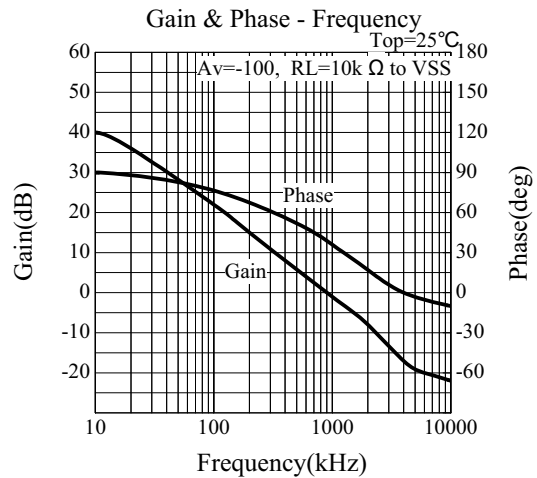
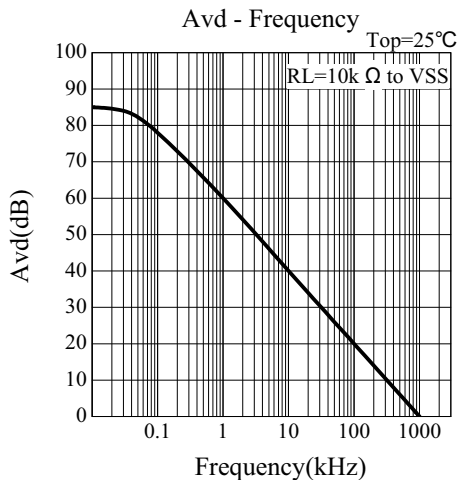
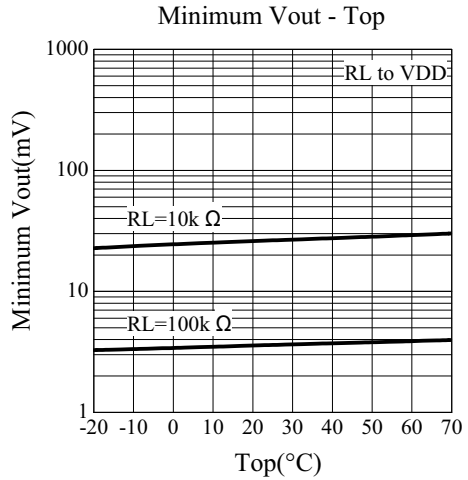
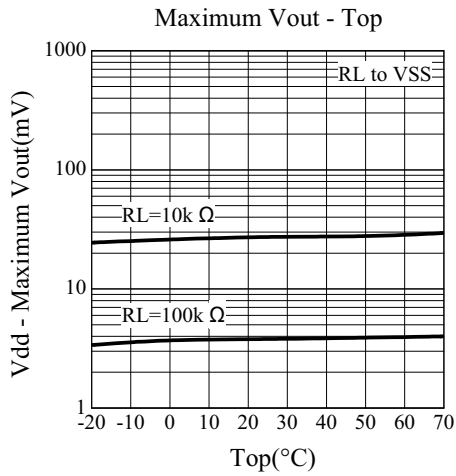
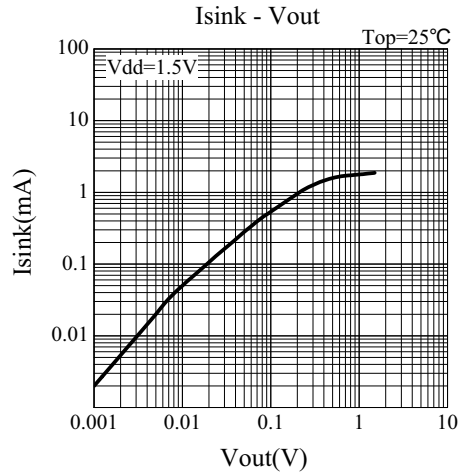
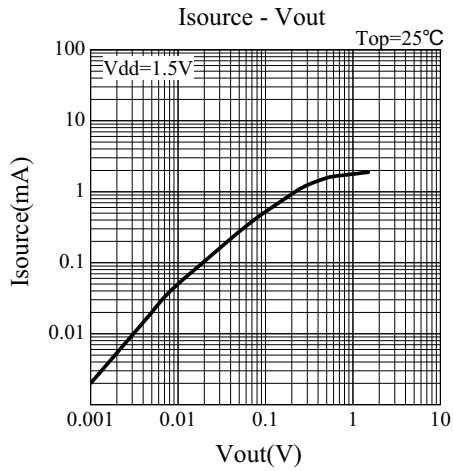

ELM854xx CMOS Dual operational amplifier

<http://www.elm-tech.com>

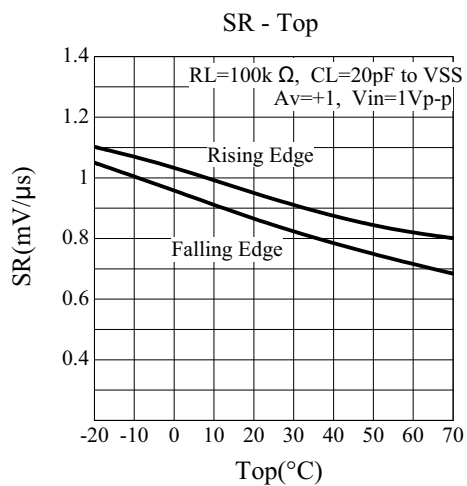
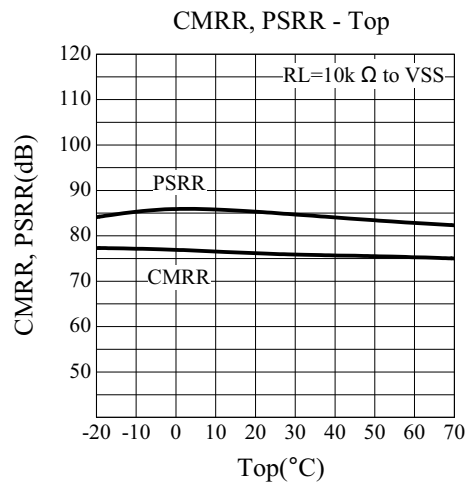
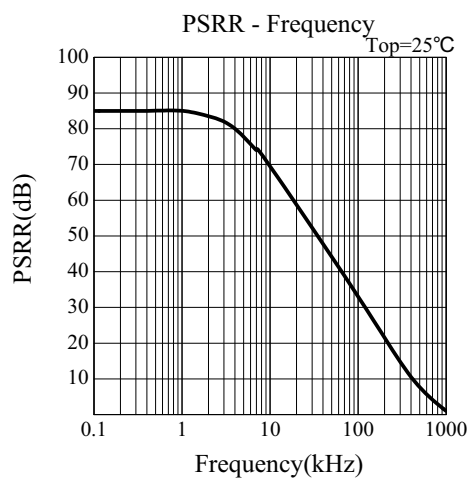
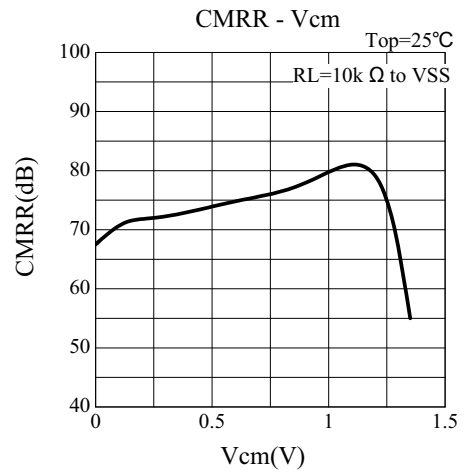
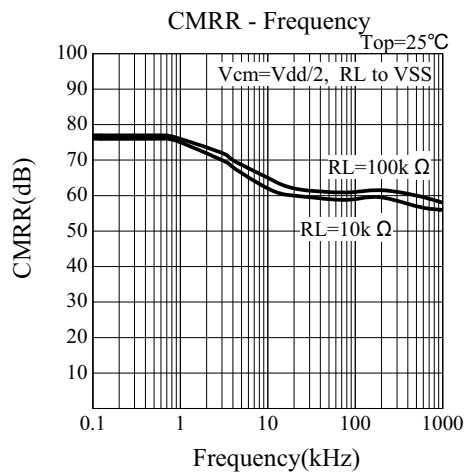

ELM854xx CMOS Dual operational amplifier

<http://www.elm-tech.com>

■ 3.0V Performance

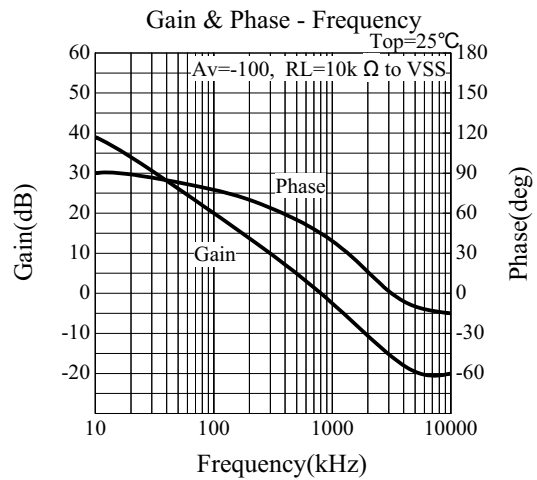
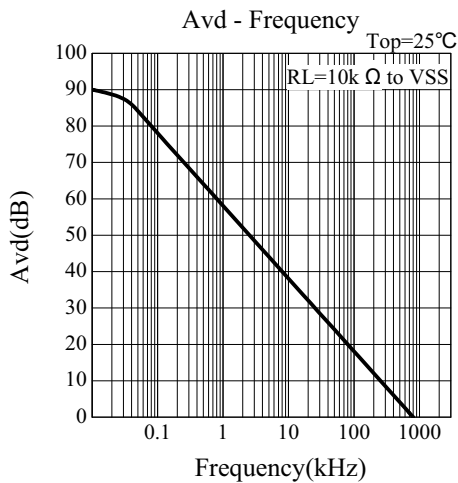
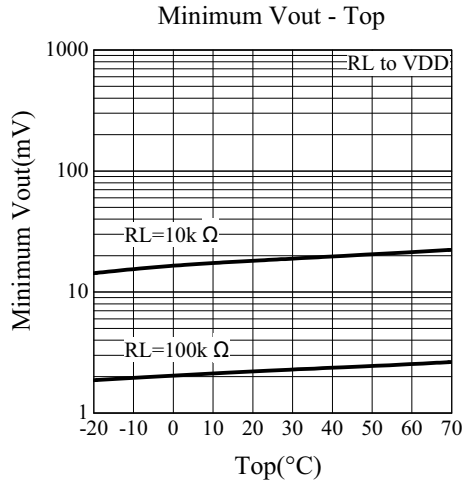
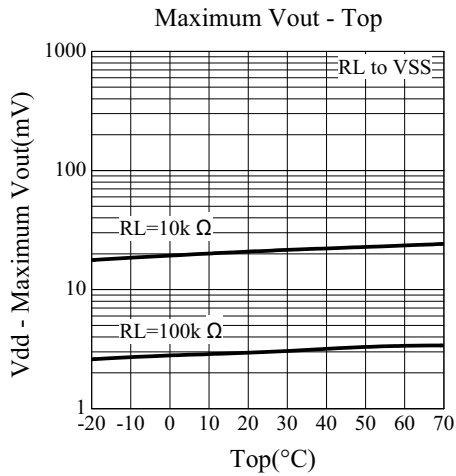
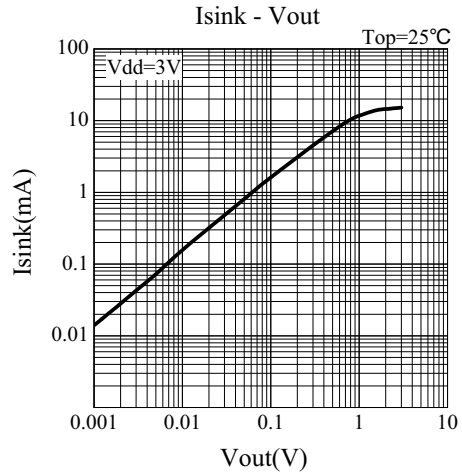
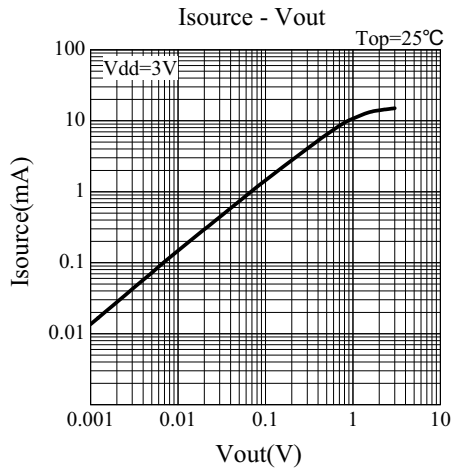

ELM854xx CMOS Dual operational amplifier

<http://www.elm-tech.com>

