

**OBSOLETE PRODUCT**  
 See HA-5127A, HA-5135  
 contact our Technical Support Center at  
 1-888-INTERSIL or www.intersil.com/tsc

**2MHz, Ultra-Low Offset Voltage Operational Amplifier**

The HA-5177 is an all bipolar, precision operational amplifier, utilizing Harris dielectric isolation and advance processing techniques. This design features a combination of precision input characteristics, wide bandwidth (2MHz) and high speed (0.8V/μs).

The HA-5177 uses advanced matching techniques and laser trimming to produce low offset voltage (20μV) and low offset voltage drift (0.2μV/°C). This design also features low voltage noise (9.0nV/√Hz), low current noise (1.2pA/√Hz), nanoamp input currents, and 120dB minimum gain.

These outstanding features along with high CMRR (140dB) and high PSRR (135dB) make this unity gain stable amplifier ideal for high resolution data acquisition systems, precision integrators, and low level transducer amplifiers.

The HA-5177 can be used as a direct replacement for the OP05, OP07, and OP77 while offering higher bandwidth and slew rate. See the HA-5177/883 data sheet for military grade parts and LCC package.

**Features**

- Low Offset Voltage . . . . . 20μV
- Low Offset Voltage Drift . . . . . 0.2μV/°C
- High Voltage Gain . . . . . 150dB
- High CMRR . . . . . 140dB
- High PSRR . . . . . 135dB
- Low Noise . . . . . 9.0nV/√Hz
- Low Power Consumption . . . . . .51mW (Max)

**Applications**

- High Gain Instrumentation Amplifiers
- Precision Control Systems
- Precision Integrators
- High Resolution Data Converters
- Precision Threshold Detectors
- Low Level Transducer Amplifiers

**Part Number Information**

PART NUMBER	TEMP. RANGE (°C)	PACKAGE	PKG. NO.
HA3-5177-5	0 to 75	8 Ld PDIP	E8.3
HA7-5177-5	0 to 75	8 Ld CERDIP	F8.3A

HA-5177  
 (PDIP, CERDIP)  
 TOP VIEW

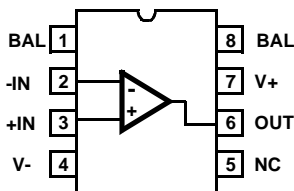

# HA-5177

## Absolute Maximum Ratings

Supply Voltage Between V+ and V- Terminals . . . . . 44V  
 Differential Input Voltage . . . . . 7V  
 Output Current . . . . . Short Circuit Protected

## Operating Conditions

Temperature Range  
 HA-5177-2 . . . . . -55°C to 125°C  
 HA-5177-5 . . . . . 0°C to 75°C

## Thermal Information

Thermal Resistance (Typical, Note 1)  $\theta_{JA}$  (°C/W)  $\theta_{JC}$  (°C/W)  
 CERDIP Package . . . . . 135 50  
 PDIP Package . . . . . 92 N/A  
 Maximum Junction Temperature (Ceramic Package) . . . . . 175°C  
 Maximum Junction Temperature (Plastic Package) . . . . . 150°C  
 Maximum Storage Temperature Range . . . . . -65°C to 150°C  
 Maximum Lead Temperature (Soldering 10s) . . . . . 300°C  
 (SOIC - Lead Tips Only)

*CAUTION: Stresses above those listed in "Absolute Maximum Ratings" may cause permanent damage to the device. This is a stress only rating and operation of the device at these or any other conditions above those indicated in the operational sections of this specification is not implied.*

### NOTE:

- $\theta_{JA}$  is measured with the component mounted on an evaluation PC board in free air.

## Electrical Specifications $V_{SUPPLY} = \pm 15V$ , Unless Otherwise Specified

PARAMETER	TEST CONDITIONS	TEMP. (°C)	MIN	TYP	MAX	UNITS
<b>INPUT CHARACTERISTICS</b>						
Offset Voltage		25	-	20	60	$\mu V$
		Full	-	40	100	$\mu V$
Average Offset Voltage Drift		Full	-	0.2	0.6	$\mu V/^\circ C$
Bias Current		25	-	1.2	6	nA
		Full	-	2.4	8	nA
Bias Current Average Drift		Full	-	15	35	$pA/^\circ C$
Offset Current		25	-	0.6	6	nA
		Full	-	1.0	8	nA
Offset Current Average Drift		Full	-	1.5	50	$pA/^\circ C$
Common Mode Range		Full	$\pm 12$	-	-	V
Differential Input Resistance		25	-	47	-	$M\Omega$
Input Noise Voltage	0.1Hz to 10Hz	25	-	0.35	0.6	$\mu V_{P-P}$
Input Noise Voltage Density	$f_O = 10Hz$	25	-	13	18	$nV/\sqrt{Hz}$
	$f_O = 100Hz$	25	-	10	13	$nV/\sqrt{Hz}$
	$f_O = 1000Hz$	25	-	9	11	$nV/\sqrt{Hz}$
Input Noise Current	0.1Hz to 10Hz	25	-	14	45	$pA_{P-P}$
Input Noise Current Density	$f_O = 10Hz$	25	-	7.1	10	$pA/\sqrt{Hz}$
	$f_O = 100Hz$	25	-	3.3	5	$pA/\sqrt{Hz}$
	$f_O = 1000Hz$	25	-	1.2	2	$pA/\sqrt{Hz}$
<b>TRANSFER CHARACTERISTICS</b>						
Large Signal Voltage Gain (Note 2)		25	126	150	-	dB
		Full	120	140	-	dB
Common Mode Rejection Ratio (Note 3)		Full	110	140	-	dB
Closed Loop Bandwidth	$A_{VCL} = +1$	25	0.6	2	-	MHz

**Electrical Specifications**  $V_{\text{SUPPLY}} = \pm 15\text{V}$ , Unless Otherwise Specified **(Continued)**

PARAMETER	TEST CONDITIONS	TEMP. (°C)	MIN	TYP	MAX	UNITS
<b>OUTPUT CHARACTERISTICS</b>						
Output Voltage Swing	$R_L = 600\Omega$	25	$\pm 10$	$\pm 12.5$	-	V
	$R_L = 2k\Omega$	25	$\pm 12$	$\pm 13$	-	V
	$R_L = 2k\Omega$	Full	$\pm 12$	$\pm 12.5$	-	V
Full Power Bandwidth (Note 5)		25	8	10	-	kHz
Output Current (Note 6)		25	15	20	-	mA
Output Resistance		25	-	60	-	$\Omega$
<b>TRANSIENT RESPONSE</b>						
Rise Time (Note 10)		25	-	310	420	ns
Slew Rate (Note 11)		25	0.5	0.8	-	V/ $\mu\text{s}$
Settling Time (Notes 7, 8)		25	-	14	-	$\mu\text{s}$
Overshoot (Note 10)		25	-	10	40	%
<b>POWER SUPPLY CHARACTERISTICS</b>						
Supply Current		Full	-	1.2	1.7	mA
Power Supply Rejection Ratio (Note 9)		Full	110	135	-	dB

NOTES:

2.  $V_{\text{OUT}} = \pm 10\text{V}$ ,  $R_L = 2k\Omega$ .
3.  $\Delta V_{\text{CM}} = \pm 10\text{V}$ .
4.  $R_L = 2k\Omega$ .
5. Full power bandwidth guaranteed based on slew rate measurement using:  $\text{FPBW} = \frac{\text{Slew Rate}}{2\pi V_{\text{PEAK}}}$ ;  $V_{\text{PEAK}} = 10\text{V}$ .
6.  $V_{\text{OUT}} = \pm 10\text{V}$ .
7. Refer to test circuits section of the data sheet.
8. Settling time is measured to 0.1% of final value for a 10V output step and  $A_V = +1$ .
9.  $\Delta V_{\text{SUPPLY}} = \pm 10\text{V}$  to  $\pm 20\text{V}$ .
10.  $A_V = 1$ ,  $R_L = 2k\Omega$ ,  $V_{\text{OUT}} = \pm 200\text{mV}$ .
11.  $A_V = 1$ ,  $R_L = 2k\Omega$ ,  $V_{\text{OUT}} = 0$  to  $\pm 3\text{V}$ .

Test Circuits and Waveforms

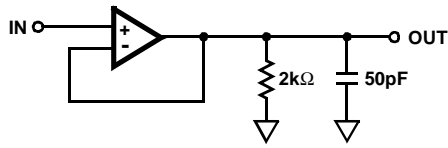
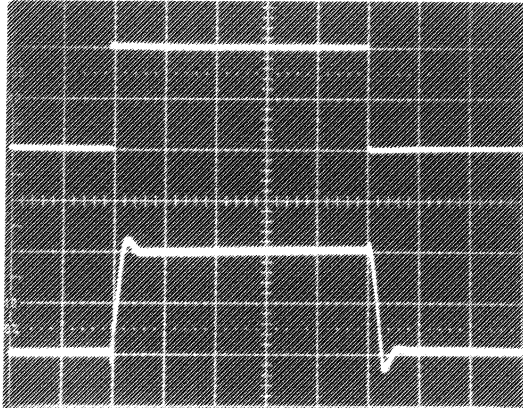
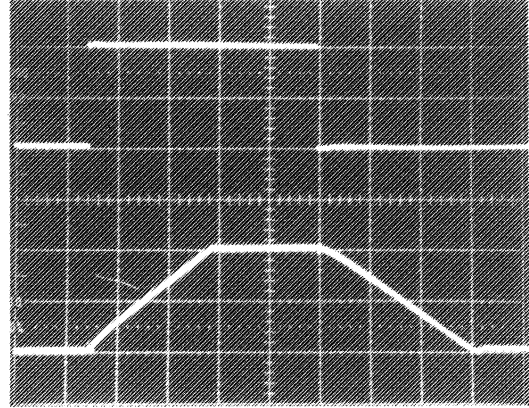

FIGURE 1. SLEW RATE AND TRANSIENT RESPONSE TEST CIRCUIT



Vertical Scale: 100mV/Div.  
Horizontal Scale: 2μs/Div.

FIGURE 2. SMALL SIGNAL RESPONSE



Vertical Scale: 5V/Div.  
Horizontal Scale: 5μs/Div.

FIGURE 3. LARGE SIGNAL RESPONSE

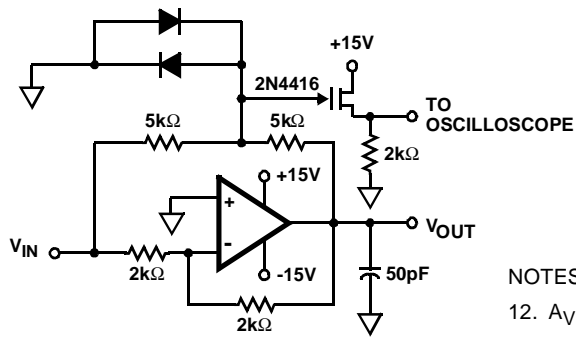

- NOTES:
- 12.  $A_V = -1$ .
  - 13. Feedback and summing resistors should be 0.1% matched.
  - 14. Clipping diodes are optional. HP5082-2810 recommended.

FIGURE 4. SETTLING TIME CIRCUIT

Schematic Diagram

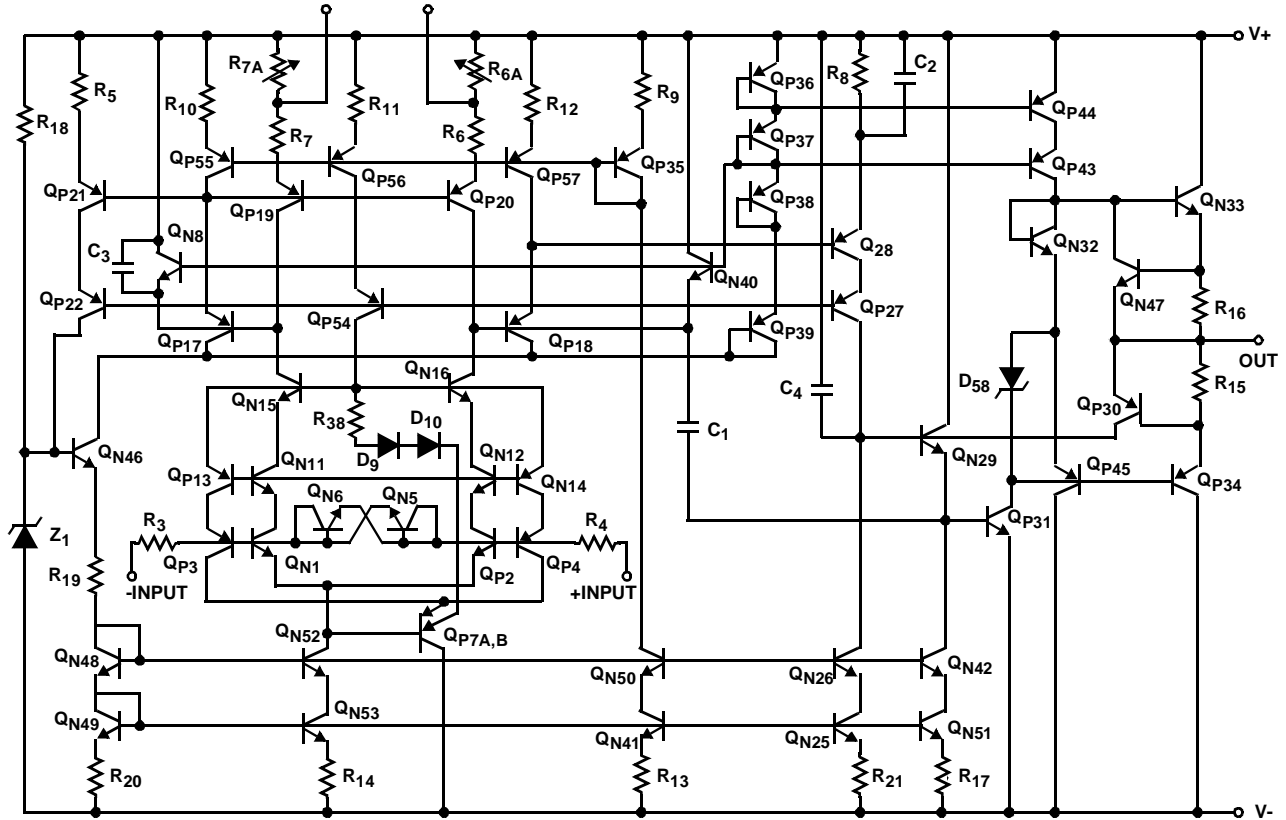

## Typical Applications

### Operation Below 15V Supply

The HA-5177 performs well down to  $\pm 5V$  supplies. At  $\pm 5V$  supplies there is a slight degradation of slew rate and open loop gain. There is very little change in bias currents and offset voltage.

### Offset Adjustment

The following is the recommended  $V_{IO}$  adjust configuration:

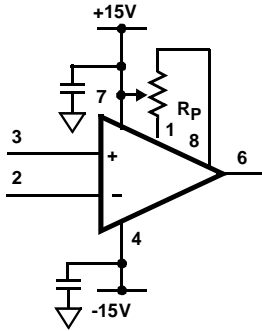

Setting  $R_P = 20K$  will give an adjustment range of  $\pm 2.6mV$ .

### Input Protection

### Typical Performance Curves $V_{SUPPLY} = \pm 15V, T_A = 25^\circ C$

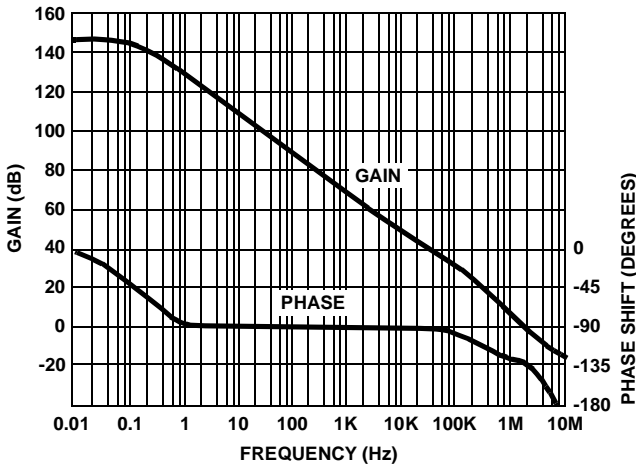
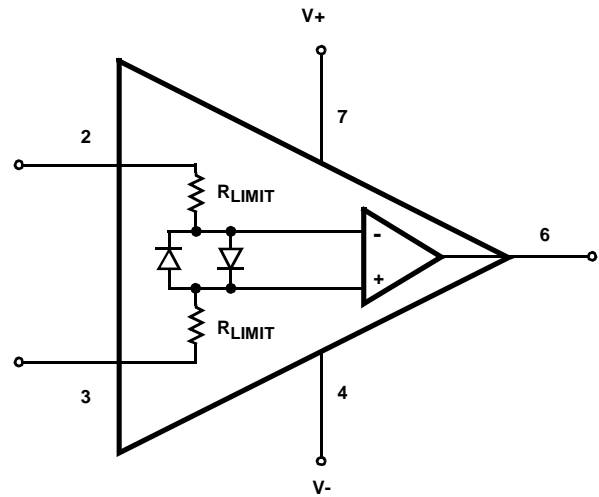

FIGURE 5. OPEN LOOP GAIN AND PHASE vs FREQUENCY

The HA-5177 input stage has built in back-to-back protection diodes with series current limiting resistors.



The Bias currents will increase when a differential voltage of 0.7V is exceeded.

The internal current limiting resistors sufficiently limit current therefore, no external resistors are required.

Refer to the "Bias Current vs Differential Input Voltage" curve in the Typical Performance Curves.

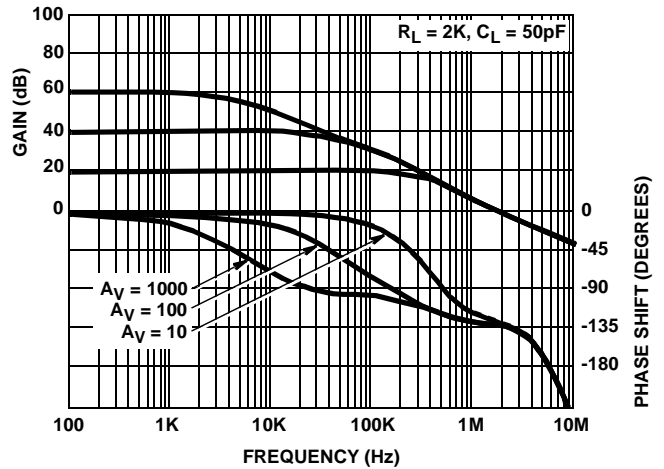

FIGURE 6. VARIOUS CLOSED LOOP GAINS vs FREQUENCY

Typical Performance Curves  $V_{SUPPLY} = \pm 15V, T_A = 25^\circ C$  (Continued)

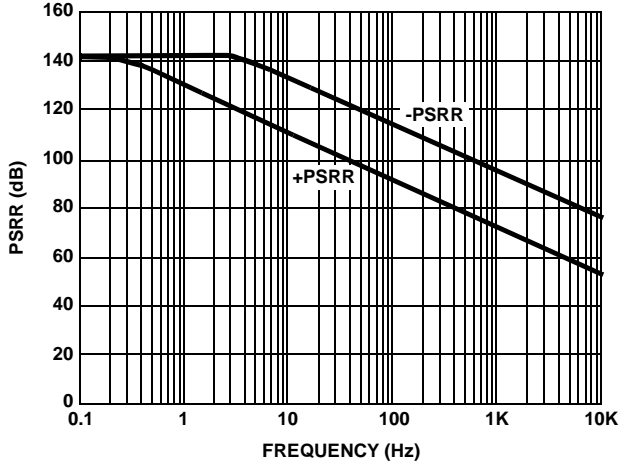

FIGURE 7. PSRR vs FREQUENCY

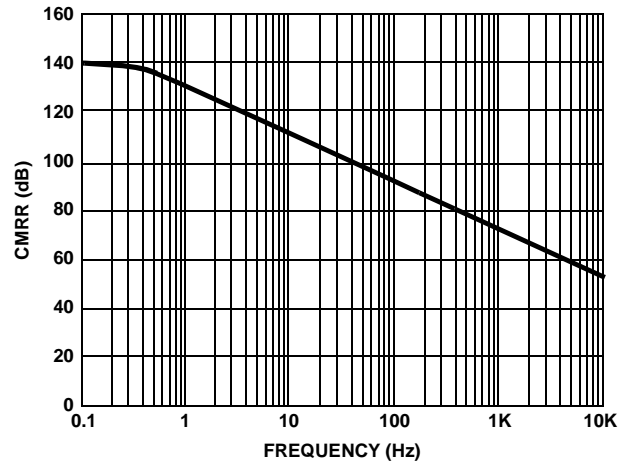

FIGURE 8. CMRR vs FREQUENCY

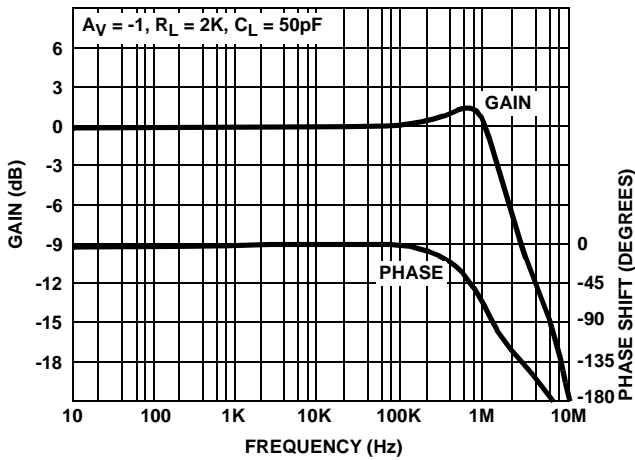

FIGURE 9. CLOSED LOOP GAIN AND PHASE vs FREQUENCY

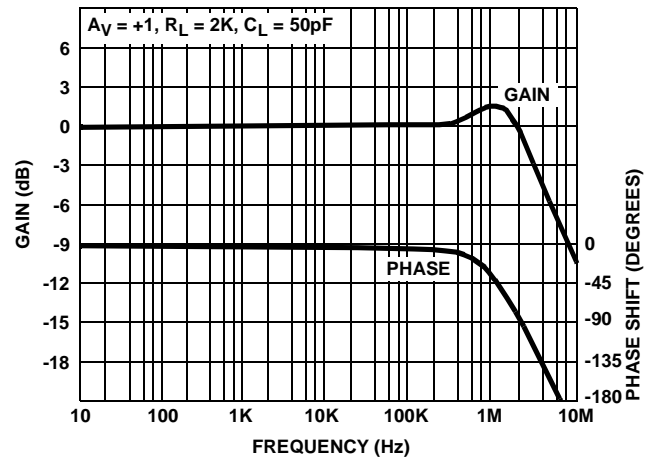

FIGURE 10. CLOSED LOOP GAIN AND PHASE vs FREQUENCY

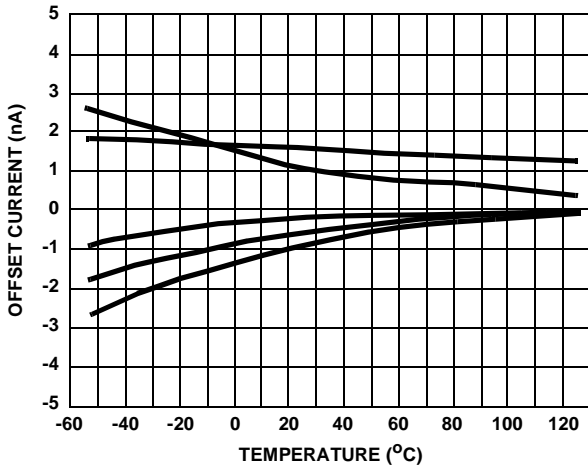

FIGURE 11. OFFSET CURRENT vs TEMPERATURE (FIVE REPRESENTATIVE UNITS)

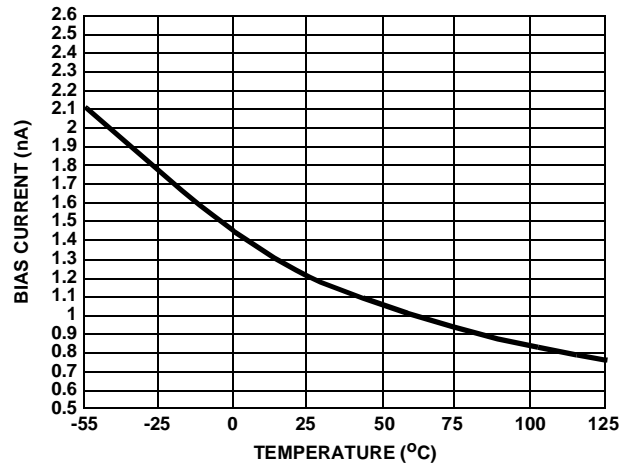

FIGURE 12. BIAS CURRENT vs TEMPERATURE

Typical Performance Curves  $V_{SUPPLY} = \pm 15V, T_A = 25^\circ C$  (Continued)

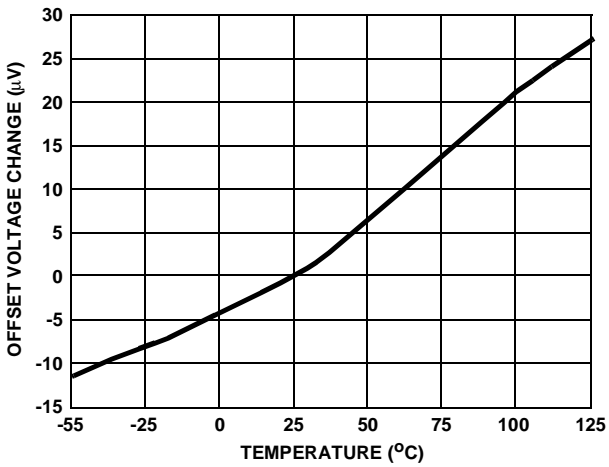

FIGURE 13. OFFSET VOLTAGE vs TEMPERATURE

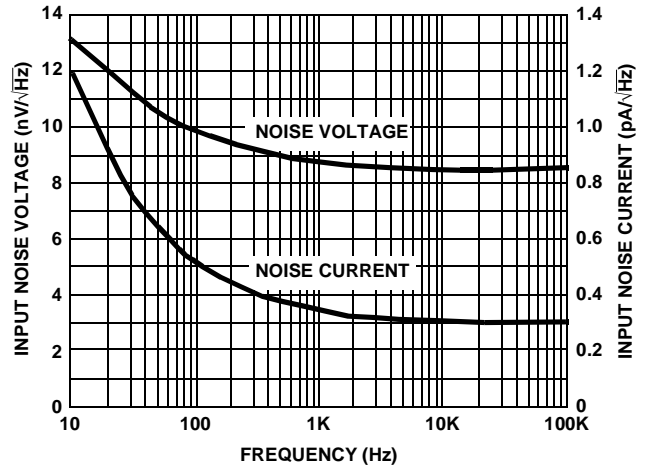

FIGURE 14. INPUT NOISE vs FREQUENCY

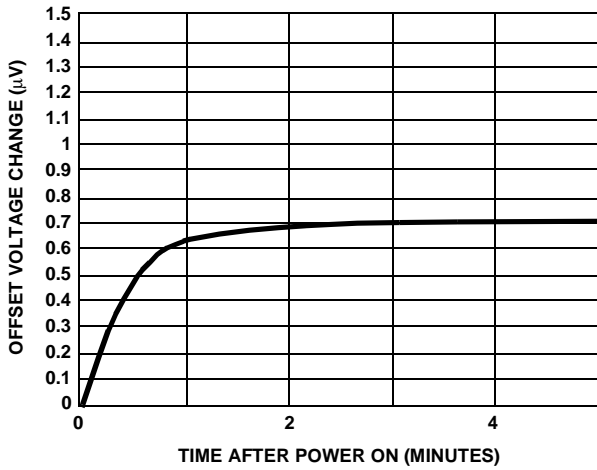

FIGURE 15. OFFSET VOLTAGE WARM-UP DRIFT

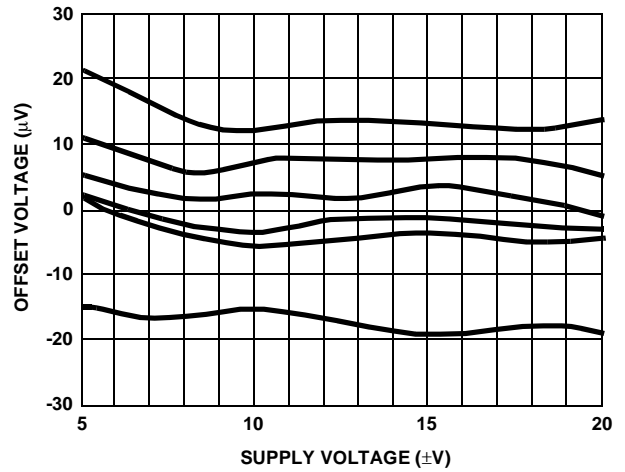

FIGURE 16. OFFSET VOLTAGE vs SUPPLY VOLTAGE (SIX REPRESENTATIVE UNITS)



Typical Performance Curves  $V_{SUPPLY} = \pm 15V, T_A = 25^\circ C$  (Continued)

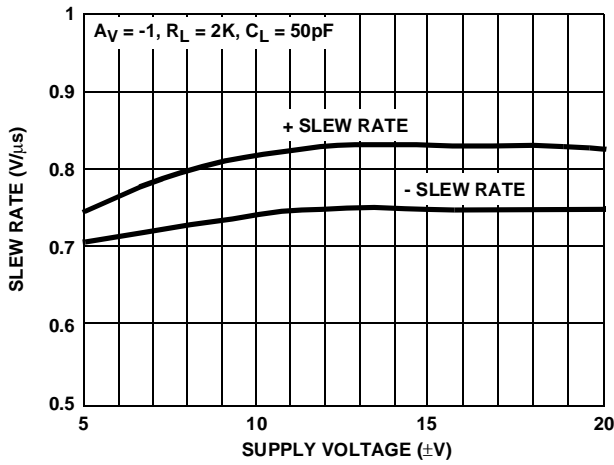

FIGURE 17. SLEW RATE vs. SUPPLY VOLTAGE

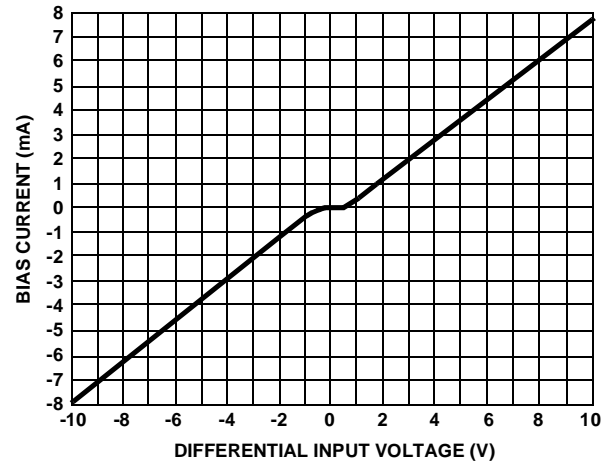

FIGURE 18. BIAS CURRENT vs DIFFERENTIAL INPUT VOLTAGE

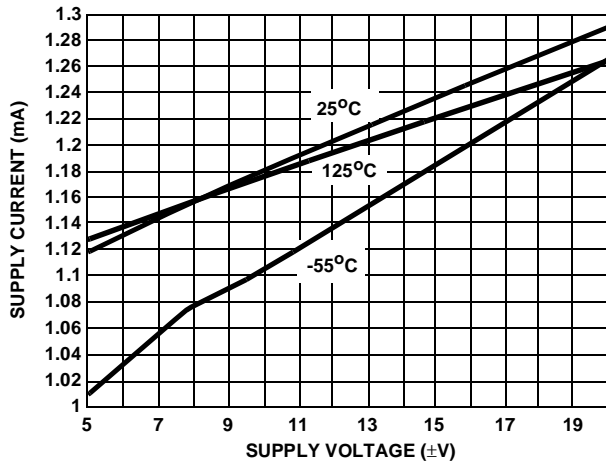

FIGURE 19. SUPPLY CURRENT vs SUPPLY VOLTAGE

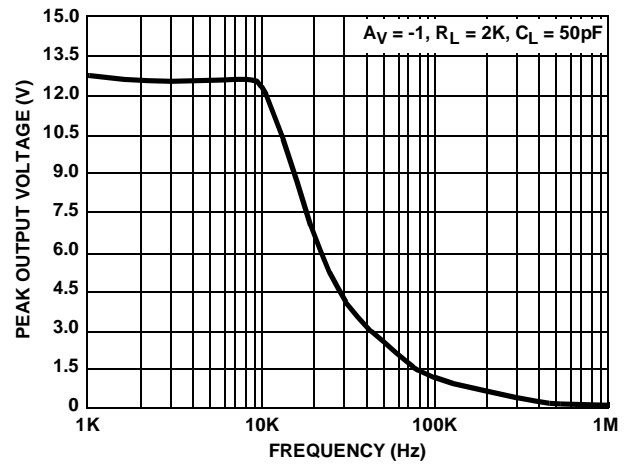

FIGURE 20. OUTPUT VOLTAGE vs FREQUENCY

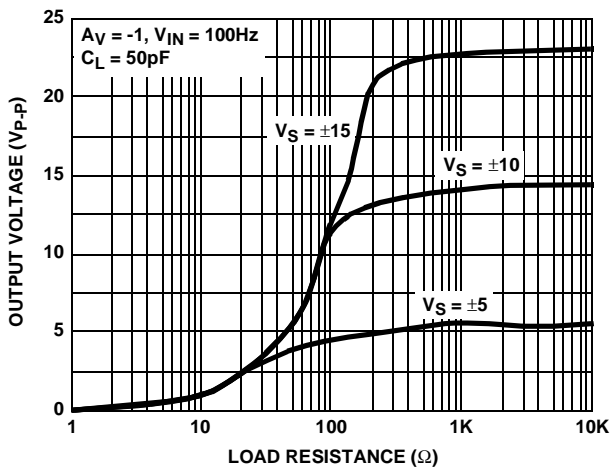

FIGURE 21. OUTPUT VOLTAGE vs LOAD RESISTANCE

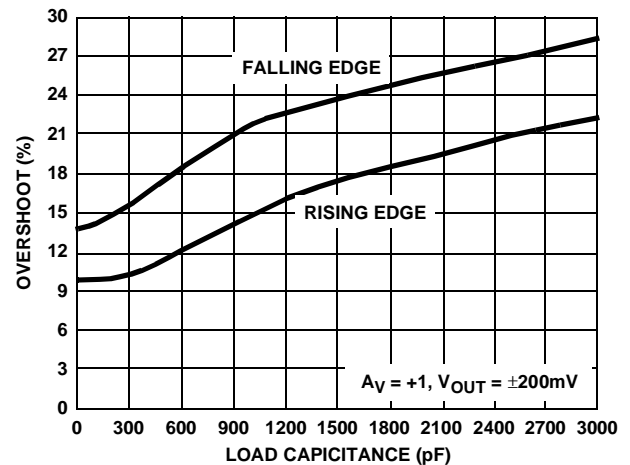

FIGURE 22. OVERSHOOT vs LOAD CAPACITANCE

Typical Performance Curves  $V_{SUPPLY} = \pm 15V, T_A = 25^\circ C$  (Continued)

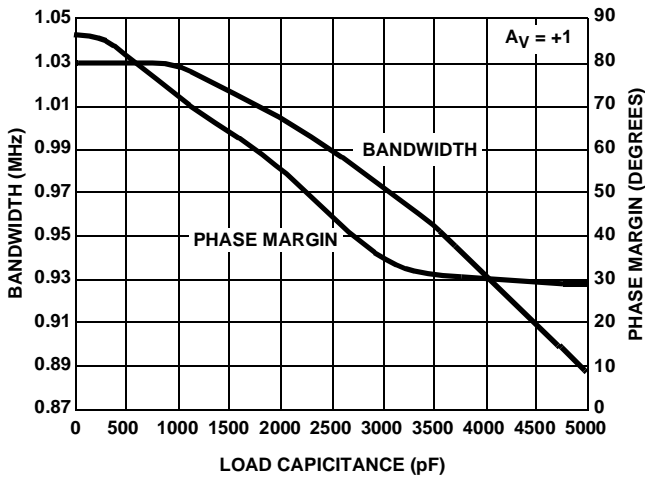
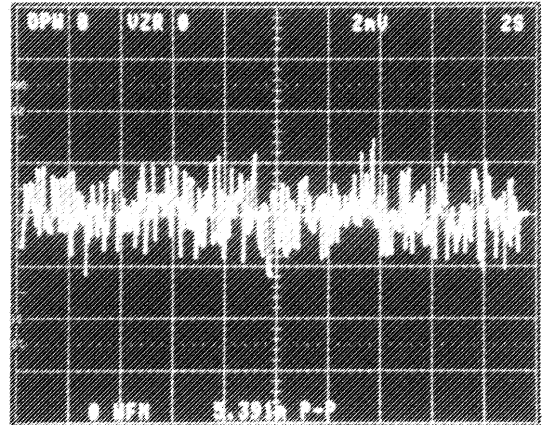

FIGURE 23. SMALL SIGNAL BANDWIDTH AND PHASE MARGIN



$A_V = 25,000, E_N = 0.22\mu V_{P-P} RTI$

FIGURE 24. PEAK-TO-PEAK NOISE (0.1Hz TO 10Hz)

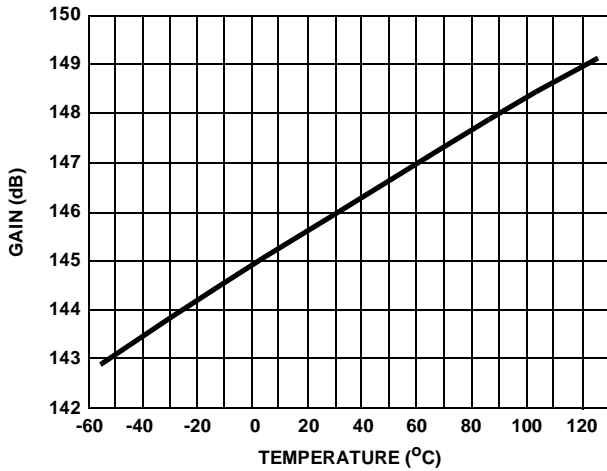

FIGURE 25. OPEN LOOP GAIN vs TEMPERATURE

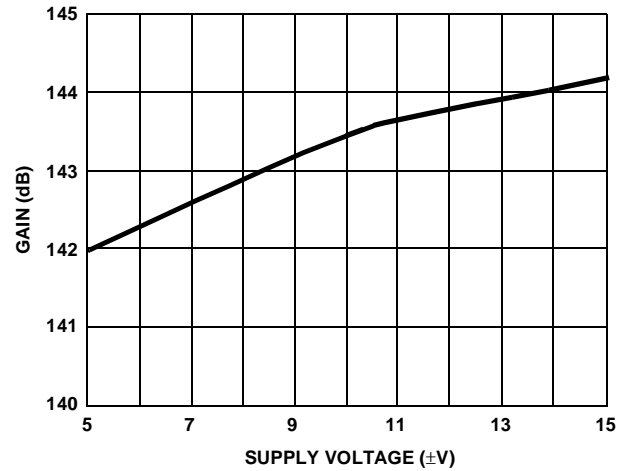

FIGURE 26. OPEN LOOP GAIN vs SUPPLY VOLTAGE

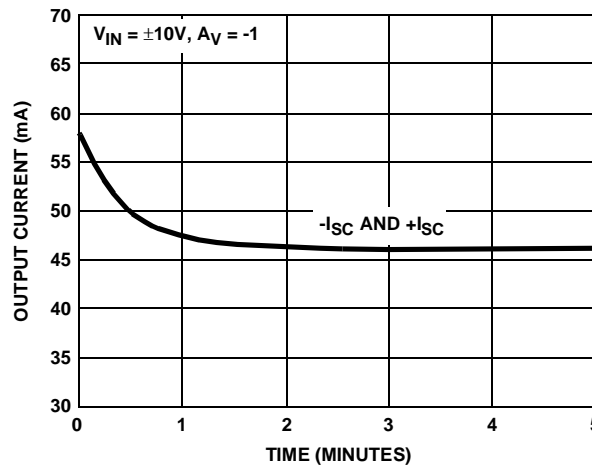

FIGURE 27. OUTPUT SHORT CIRCUIT CURRENT vs TIME