

**Programmable Quick Turn Clock™**

**FEATURES**

- Advanced programmable PLL design
- Very low Jitter and Phase Noise (30-70ps Pk-Pk typical)
- Up to 3 programmable outputs
- Output frequency up to 200MHz CMOS.
- Accepts Crystal or reference clock inputs
  - Fundamental crystal: 10MHz-30MHz
  - 3<sup>RD</sup> overtone crystal: Up to 75MHz
  - Reference input: Up to 200MHz
- Accepts <1.0V reference signal input voltage
- One programmable I/O pin can be configured as Programmable clock, or Frequency Selection input, or output Enable (OE) or Power Down (PDB) input.
- Single 2.5V or 3.3V ± 10% power supply
- Operating temperature range from -40°C to 85°C
- Available in 8-pin MSOP/SOIC, and 6-pin SOT Green/ RoHS compliant Packages

**PIN CONFIGURATION**

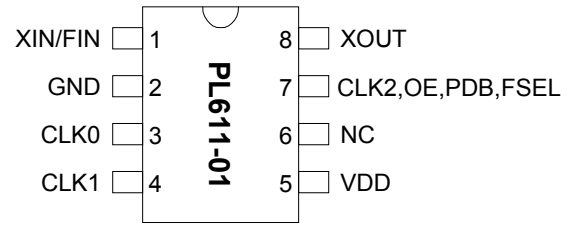

**SOP-8  
MSOP-8**

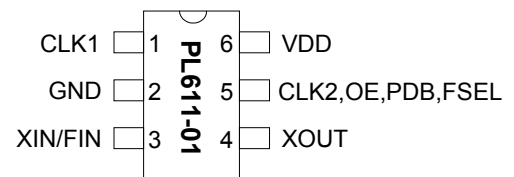

**SOT-6**

**DESCRIPTION**

The PL611-01 is a low-cost general purpose frequency synthesizer and a member of PhaseLink's Factory Programmable 'Quick Turn Clock (QTC)' family. PhaseLink's PL611-01 product family offers the versatility of using a single Crystal or Reference Clock input and producing up to three different system clocks. They can generate any output frequency up to 200 MHz from fundamental crystal input between 10 MHz - 30 MHz, or a 3rd overtone crystal of up to 75MHz, or a Reference clock input of up to 200 MHz. Cascading of the ICs to produce additional clock frequencies is also supported.

**BLOCK DIAGRAM**

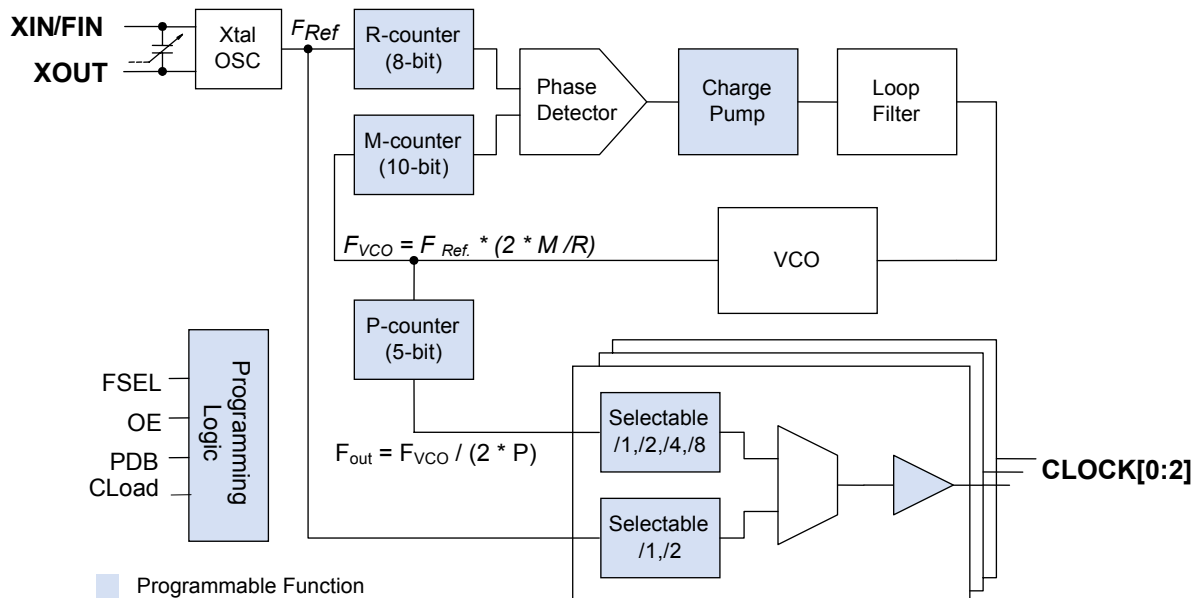

**Programmable Quick Turn Clock™**
**KEY PROGRAMMING PARAMETERS**

CLK[ 0:2 ] Output Frequency	Output Drive Strength	Crystal Load	Programmable Input/Output	Charge-Pump Current
$F_{out} = F_{IN} * M / (R * P)$ where M=10 bit R= 8 bit P= 5 bit 1. CLK[0:2]= $F_{out}/[1,2,4,8]$ 2. CLK[0:2]= $F_{IN}$ or $F_{IN}/2$	Std: 10mA (default)  High: 24mA	+/- 200ppm tuning.	One output pin can be configured as 1. CLK2 - output 2. FSEL - input 3. OE - input 4. PDB - input	4 levels of pump current settings

**PIN DESCRIPTION**

Name	Pin #		Type	Description												
	MSOP-8 SOIC-8	SOT-23														
XIN/FIN	1	3	I	Crystal or Reference input pin												
GND	2	2	P	GND connection												
CLK[0:1]	3,4	1	O	Programmable Clock Output												
VDD	5	6	P	VDD connection (2.25~3.63V)												
NC	6			No Connect												
CLK2, OE, PDB, FSEL	7	5	B	This programmable I/O pin can be configured as a programmable clock output (CLK2), or Output Enable (OE) input, or Power Down input (PDB), or Frequency Selection (FSEL) input pin. This pin has an internal 60KΩ pull up resistor. <table border="1" data-bbox="873 1331 1377 1566"> <thead> <tr> <th>State</th> <th>OE</th> <th>PDB</th> <th>FSEL</th> </tr> </thead> <tbody> <tr> <td>0</td> <td>Tristate CLK[0:1]</td> <td>Power Down Mode</td> <td>Select Freq. '1'</td> </tr> <tr> <td>1 (default)</td> <td>Normal mode</td> <td>Normal mode</td> <td>Select Freq. '2'</td> </tr> </tbody> </table>	State	OE	PDB	FSEL	0	Tristate CLK[0:1]	Power Down Mode	Select Freq. '1'	1 (default)	Normal mode	Normal mode	Select Freq. '2'
State	OE	PDB	FSEL													
0	Tristate CLK[0:1]	Power Down Mode	Select Freq. '1'													
1 (default)	Normal mode	Normal mode	Select Freq. '2'													
XOUT	8	4	O	Crystal output pin												

**Programmable Quick Turn Clock™**
**ELECTRICAL SPECIFICATIONS**
**ABSOLUTE MAXIMUM RATINGS**

PARAMETERS	SYMBOL	MIN.	MAX.	UNITS
Supply Voltage Range	V <sub>DD</sub>	-0.5	4.6	V
Input Voltage Range	V <sub>I</sub>	-0.5	V <sub>DD</sub> +0.5	V
Output Voltage Range	V <sub>O</sub>	-0.5	V <sub>DD</sub> +0.5	V
Soldering Temperature (Green package)			260	°C
Data Retention @ 85°C		10		Year
Storage Temperature	T <sub>S</sub>	-65	150	°C
Ambient Operating Temperature		-40	85	°C

Exposure of the device under conditions beyond the limits specified by Maximum Ratings for extended periods may cause permanent damage to the device and affect product reliability. These conditions represent a stress rating only, and functional operations of the device at these or any other conditions above the operational limits noted in this specification is not implied.

**AC SPECIFICATIONS**

PARAMETERS	CONDITIONS	MIN.	TYP.	MAX.	UNITS
Crystal Input Frequency(XIN)	Fundamental Crystal	10		30	MHz
	3 <sup>rd</sup> Overtone Crystal			75	MHz
Input (FIN) Frequency				200	MHz
Input (FIN) Signal Amplitude	Internally AC coupled	0.9		V <sub>DD</sub>	V <sub>pp</sub>
PLL Settling Time	After Crystal Start Up (Crystal Input)			100	μs
	After Reference Input Present (FIN)			100	μs
Output Rise Time	15pF Load, 10/90%V <sub>DD</sub> , Standard drive		2.5	3.5	ns
	15pF Load, 10/90%V <sub>DD</sub> , High drive		1.0	1.5	ns
Output Fall Time	15pF Load, 90/10%V <sub>DD</sub> , Standard drive		2.5	3.5	ns
	15pF Load, 90/10%V <sub>DD</sub> , High drive		1.0	1.5	ns
Duty Cycle	At V <sub>DD</sub> /2	45	50	55	%
Max. output skew between same frequency clocks	Equal loading (15 pF). Equal frequency & drive strength			500	ps
Period Jitter, peak-to-peak* (measured from 10,000 samples)	With capacitive decoupling between V <sub>DD</sub> and GND. Operating only one output.		70		ps

\* Note: Jitter performance depends on the programming parameters.

**Programmable Quick Turn Clock™**
**DC SPECIFICATIONS**

PARAMETERS	SYMBOL	CONDITIONS	MIN.	TYP.	MAX.	UNITS
Supply Current, Dynamic, with Loaded Outputs	I <sub>DD</sub>	At 10MHz, load=15pF (PDB=1)			15	mA
		PDB=0			5	μA
Operating Voltage	V <sub>DD</sub>		2.25		3.63	V
Output Low Voltage	V <sub>OL</sub>	I <sub>OL</sub> = +4mA Standard drive			0.4	V
Output High Voltage	V <sub>OH</sub>	I <sub>OH</sub> = -4mA Standard drive	V <sub>DD</sub> - 0.4			V
Output Current, Standard drive	I <sub>OSD</sub>	V <sub>OL</sub> = 0.4V, V <sub>OH</sub> = 2.4V			10	mA
Output Current, High drive	I <sub>OHD</sub>	V <sub>OL</sub> = 0.4V, V <sub>OH</sub> = 2.4V			24	mA
Short-circuit Current	I <sub>S</sub>			±50		mA

**CRYSTAL SPECIFICATIONS**

PARAMETERS	SYMBOL	MIN.	TYP.	MAX.	UNITS
Fundamental Crystal Resonator Frequency	F <sub>XIN</sub>	10		30	MHz
3 <sup>rd</sup> Overtone Crystal Resonator Frequency	F <sub>XIN</sub>			75	MHz
Crystal Loading Rating (The IC can be programmed for any value in this range.)	C <sub>L (xtal)</sub>	5		20	pF
Maximum Sustainable Drive Level				500	μW
Operating Drive Level			100		μW
Crystal Shunt Capacitance	C <sub>0</sub>			6	pF
Effective Series Resistance, Fundamental, 10-30MHz	ESR			30	Ω
Effective Series Resistance, 3 <sup>rd</sup> Overtone, 30-50MHz [C <sub>0</sub> < 4pF, C <sub>L</sub> =(5pF)/(8pF)]	ESR			100/70	Ω
Effective Series Resistance, 3 <sup>rd</sup> Overtone, 50-65MHz, [C <sub>0</sub> < 4pF, C <sub>L</sub> =5pF(5pF)/(8pF)]	ESR			60/40	Ω
Effective Series Resistance, 3 <sup>rd</sup> Overtone, 65-75MHz [C <sub>0</sub> < 4pF, C <sub>L</sub> =(5pF)/(8pF)]	ESR			45/30	Ω

Note: A detailed crystal specification document is also available for this part

**Programmable Quick Turn Clock™**

**PACKAGE DRAWINGS (GREEN PACKAGE COMPLIANT)**

**MSOP 8L**

Symbol	Dimension in MM	
	Min.	Max.
A	---	1.10
A1	0.05	0.15
A2	0.81	0.91
B	0.25	0.40
C	0.13	0.23
D	2.90	3.10
E	2.90	3.10
H	4.90 BSC	
L	0.445	0.648
e	0.65 BSC	

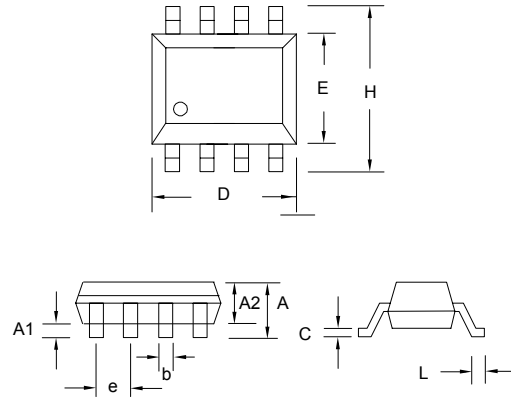

**SOIC 8L**

Symbol	Dimension in MM	
	Min.	Max.
A	1.35	1.75
A1	0.10	0.25
A2	1.25	1.50
B	0.33	0.53
C	0.19	0.27
D	4.80	5.00
E	3.80	4.00
H	5.80	6.20
L	0.40	0.89
e	1.27 BSC	

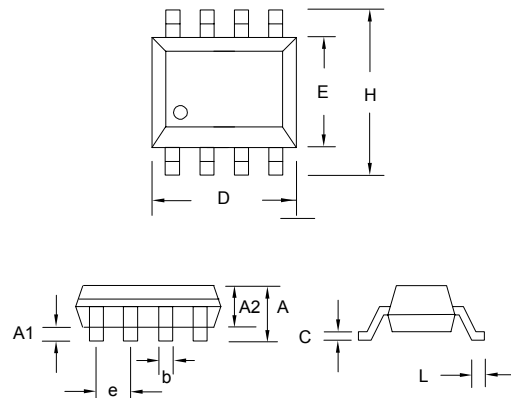

**SOT-23 6 L**

Symbol	Dimension in MM	
	Min.	Max.
A	1.05	1.35
A1	0.05	0.15
A2	1.00	1.20
B	0.30	0.50
C	0.08	0.20
D	2.80	3.00
E	1.50	1.70
H	2.60	3.0
L	0.35	0.55
e	0.95 BSC	

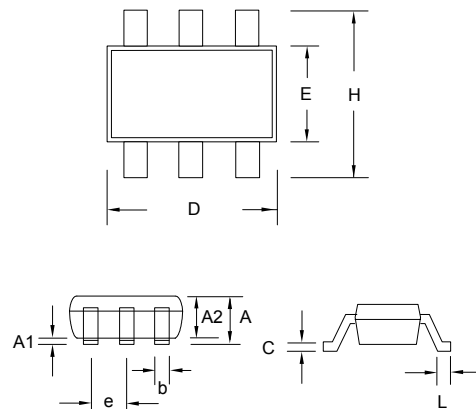

**Programmable Quick Turn Clock™**

**ORDERING INFORMATION**

**For part ordering, please contact our Sales Department:**

47745 Fremont Blvd., Fremont, CA 94538, USA

Tel: (510) 492-0990 Fax: (510) 492-0991

**PART NUMBER**

The order number for this device is a combination of the following:  
Device number, Package type and Operating temperature range

**PL611-XXX X X-R**

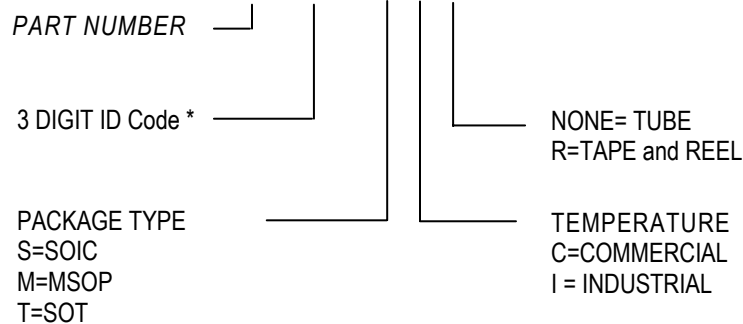

- \* PhaseLink will assign a unique 3-digit ID code for each approved programmed part number.
- \* PhaseLink offers Green Package Only for this product family.

Part / Order Number*	Marking	Package Option
PL611-01-XXXSC	C1XXX	8-Pin SOIC (Tube)
PL611-01-XXXSC-R	C1XXX	8-Pin SOIC (Tape and Reel)
PL611-01-XXXMC	C1XXX	8-Pin MSOP (Tube)
PL611-01-XXXMC-R	C1XXX	8-Pin MSOP (Tape and Reel)
PL611-01-XXXTC-R	C1XXX	6-Pin SOT-23 (Tape and Reel)

\* Ordering will include Programming ID number that will be supplied at the time the samples are provided.

PhaseLink Corporation, reserves the right to make changes in its products or specifications, or both at any time without notice. The information furnished by Phaselink is believed to be accurate and reliable. However, PhaseLink makes no guarantee or warranty concerning the accuracy of said information and shall not be responsible for any loss or damage of whatever nature resulting from the use of, or reliance upon this product.

**LIFE SUPPORT POLICY:** PhaseLink's products are not authorized for use as critical components in life support devices or systems without the express written approval of the President of PhaseLink Corporation.