

Applications

- Military radar
- Civilian radar
- Professional and military radio communications
- Test instrumentation
- Wideband or narrowband amplifiers
- Jammers



Product Features

- Frequency: DC to 3.5 GHz
- Output Power (P_{3dB}): 260 W Peak (48 Watts Avg.) at 2.9 GHz
- Linear Gain: 16 dB typical at 2.9 GHz
- Operating Voltage: 36 V
- Low thermal resistance package

Functional Block Diagram

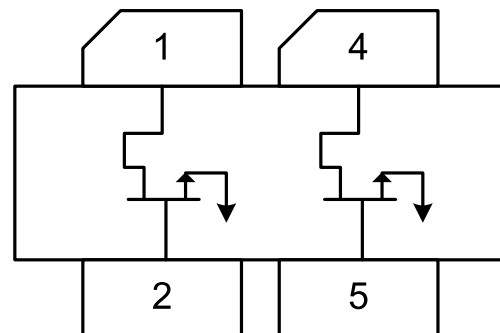

General Description

The TriQuint T1G4020036-FS is a 240 W Peak (48 W Avg.) (P_{3dB}) discrete GaN on SiC HEMT which operates from DC to 3.5 GHz. The device is constructed with TriQuint's proven TQGaN25HV process, which features advanced field plate techniques to optimize power and efficiency at high drain bias operating conditions. This optimization can potentially lower system costs in terms of fewer amplifier line-ups and lower thermal management costs.

Lead-free and ROHS compliant

Evaluation boards are available upon request.

Pin Configuration

Pin No.	Label
1, 4	V_D / RF OUT
2, 5	V_G / RF IN
Flange	Source

Ordering Information

Part	ECCN	Description
T1G4020036-FS	3A001b.3.b	Packaged part Flangeless
T1G4020036-FS-EVB1	EAR99	2.9-3.3 GHz Evaluation Board

Absolute Maximum Ratings

Parameter	Value
Breakdown Voltage (V_{D0})	145 V min.
Gate Voltage Range (V_G)	-10 to 0 V
Drain Current (I_D)	24 A
Gate Current (I_G)	-57.6 to 67.2 mA
Power Dissipation (CW P_D)	236 W
RF Input Power, CW, $T = 25^\circ\text{C}$ (P_{IN})	47.5 dBm
Channel Temperature (T_{CH})	275 $^\circ\text{C}$
Mounting Temperature (30 Seconds)	320 $^\circ\text{C}$
Storage Temperature	-40 to 150 $^\circ\text{C}$

Operation of this device outside the parameter ranges given above may cause permanent damage. These are stress ratings only, and functional operation of the device at these conditions is not implied.

Recommended Operating Conditions

Parameter	Value
Drain Voltage (V_D)	36 V (Typ.)
Drain Quiescent Current (I_{DQ})	520 mA (Typ.)
Peak Drain Current (I_D), Pulse	12 A (Typ.)
Gate Voltage (V_G)	-2.9 V (Typ.)
Channel Temperature (T_{CH})	250 $^\circ\text{C}$ (Max.)
Power Dissipation (P_D), CW, 85 $^\circ\text{C}$ Tbase	211 W (Max)
Power Dissipation (P_D), Pulse, 85 $^\circ\text{C}$ Tbase	374 W (Max)

Electrical specifications are measured at specified test conditions. Specifications are not guaranteed over all recommended operating conditions.

Pulse signal: 100 μs pulse width, 20% duty cycle

RF Characterization – Load Pull Performance at 3.1 GHz ⁽¹⁾

Test conditions unless otherwise noted: $T_A = 25^\circ\text{C}$, $V_D = 36\text{ V}$, $I_{DQ} = 260\text{ mA}$ (half device)

Symbol	Parameter	Min	Typical	Max	Units
G_{LIN}	Linear Gain, Power Tuned		16.1		dB
P_{3dB}	Output Power at 3 dB Gain Compression, Power Tuned		155		W
PAE_{3dB}	Power-Added Efficiency at 3 dB Gain Compression, Efficiency Tuned		64		%
G_{3dB}	Gain at 3 dB Compression, Power Tuned		13.1		dB

Notes:

1. Pulse: 100 μs pulse width, 20% duty cycle

RF Characterization – Load Pull Performance at 3.5 GHz ⁽¹⁾

Test conditions unless otherwise noted: $T_A = 25^\circ\text{C}$, $V_D = 36\text{ V}$, $I_{DQ} = 260\text{ mA}$ (half device)

Symbol	Parameter	Min	Typical	Max	Units
G_{LIN}	Linear Gain, Power Tuned		16.8		dB
P_{3dB}	Output Power at 3 dB Gain Compression, Power Tuned		140		W
PAE_{3dB}	Power-Added Efficiency at 3 dB Gain Compression, Efficiency Tuned		58.5		%
G_{3dB}	Gain at 3 dB Compression, Power Tuned		13.8		dB

Notes:

1. Pulse: 100 μs pulse width, 20% duty cycle

RF Characterization – Narrow Band Performance at 2.9 GHz^(1,2,3)

Test conditions unless otherwise noted: $T_A = 25\text{ }^\circ\text{C}$, $V_D = 36\text{ V}$, $I_{DQ} = 520\text{ mA}$ (combined), Pulsed

Symbol	Parameter	Typical
VSWR	Impedance Mismatch Ruggedness	10:1

Notes:

1. Performance at 2.9 GHz in the 2.9 to 3.3 GHz Evaluation Board
2. Pulse: 100 μs , 20%
3. Tested input power established at P3dB at power match condition

RF Characterization – Performance at 2.9 GHz^(1, 2)

Test conditions unless otherwise noted: $T_A = 25\text{ }^\circ\text{C}$, $V_D = 36\text{ V}$, $I_{DQ} = 520\text{ mA}$ (combined)

Symbol	Parameter	Min	Typical	Max	Units
G_{LIN}	Linear Gain		16.1		dB
P_{3dB}	Output Power at 3 dB Gain Compression		260.0		W
DE_{3dB}	Drain Efficiency at 3 dB Gain Compression		52.0		%
G_{3dB}	Gain at 3 dB Compression		13.1		dB

Notes:

1. Performance at 2.9 GHz in the 2.9 to 3.3 GHz Evaluation Board
2. Pulse: 100 μs , 20%

Thermal and Reliability Information

Parameter	Test Conditions	Value	Units
Thermal Resistance (θ_{JC})	Tbase = 85°C, Pdiss = 211W	0.78	°C/W
Channel Temperature (T_{CH})	CW	250	°C
Thermal Resistance (θ_{JC})	Tbase = 85°C, Pdiss = 230.4W	0.40	°C/W
Channel Temperature (T_{CH})	Pulse: 100uS, 20%	177	°C
Thermal Resistance (θ_{JC})	Tbase = 85°C, Pdiss = 230.4W	0.36	°C/W
Channel Temperature (T_{CH})	Pulse: 100uS, 10%	168	°C
Thermal Resistance (θ_{JC})	Tbase = 85°C, Pdiss = 230.4W	0.47	°C/W
Channel Temperature (T_{CH})	Pulse: 300uS, 20%	194	°C
Thermal Resistance (θ_{JC})	Tbase = 85°C, Pdiss = 230.4W	0.43	°C/W
Channel Temperature (T_{CH})	Pulse: 300uS, 10%	185	°C

Notes:

Thermal resistance measured to bottom of package.

Median Lifetime

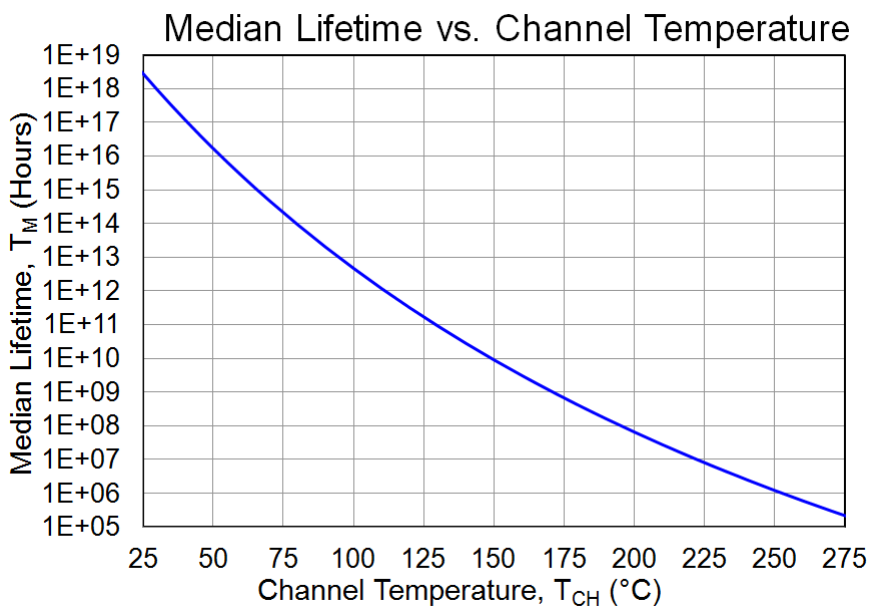

Maximum Channel Temperature

$T_{BASE} = 85^{\circ}C$, $P_D = 230 W$

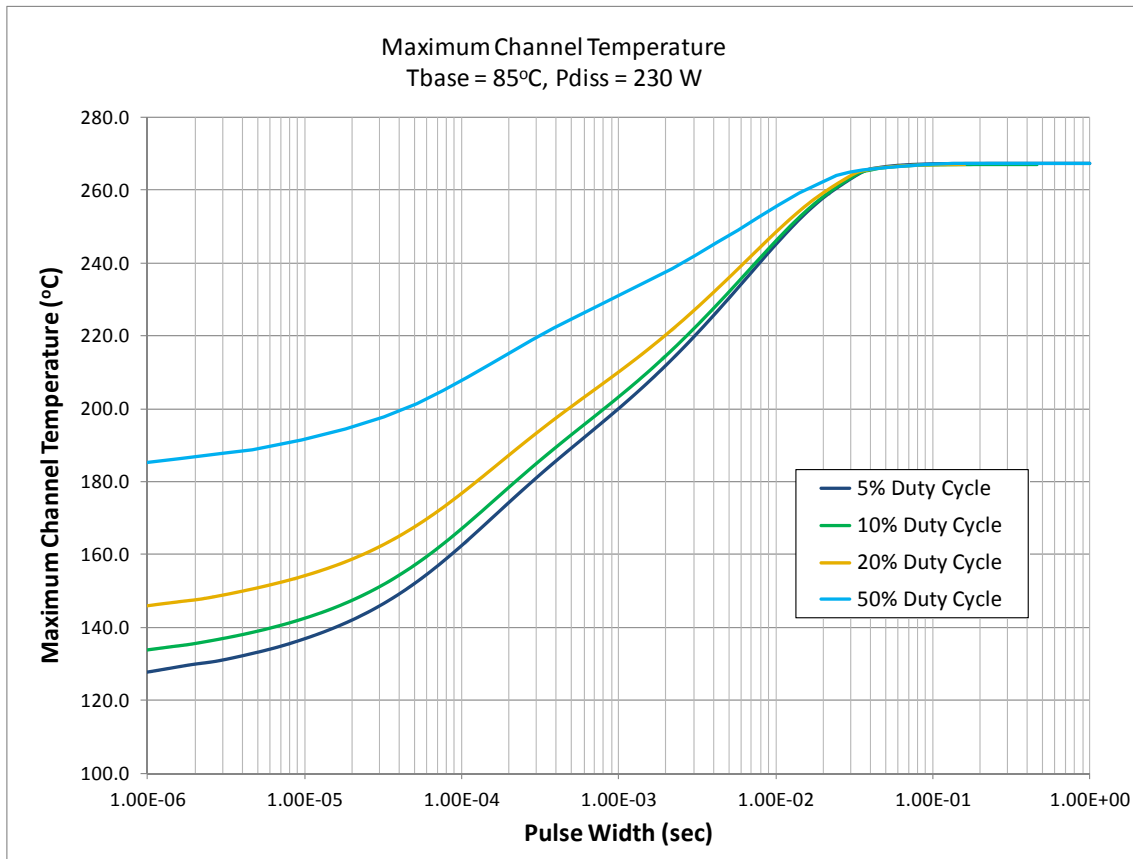

Load Pull Smith Charts (1, 2)

RF performance that the device typically exhibits when placed in the specified impedance environment. The impedances are not the impedances of the device, they are the impedances presented to the device via an RF circuit or load-pull system. The impedances listed follow an optimized trajectory to maintain high power and high efficiency. The impedances are for one independent half of the device only.

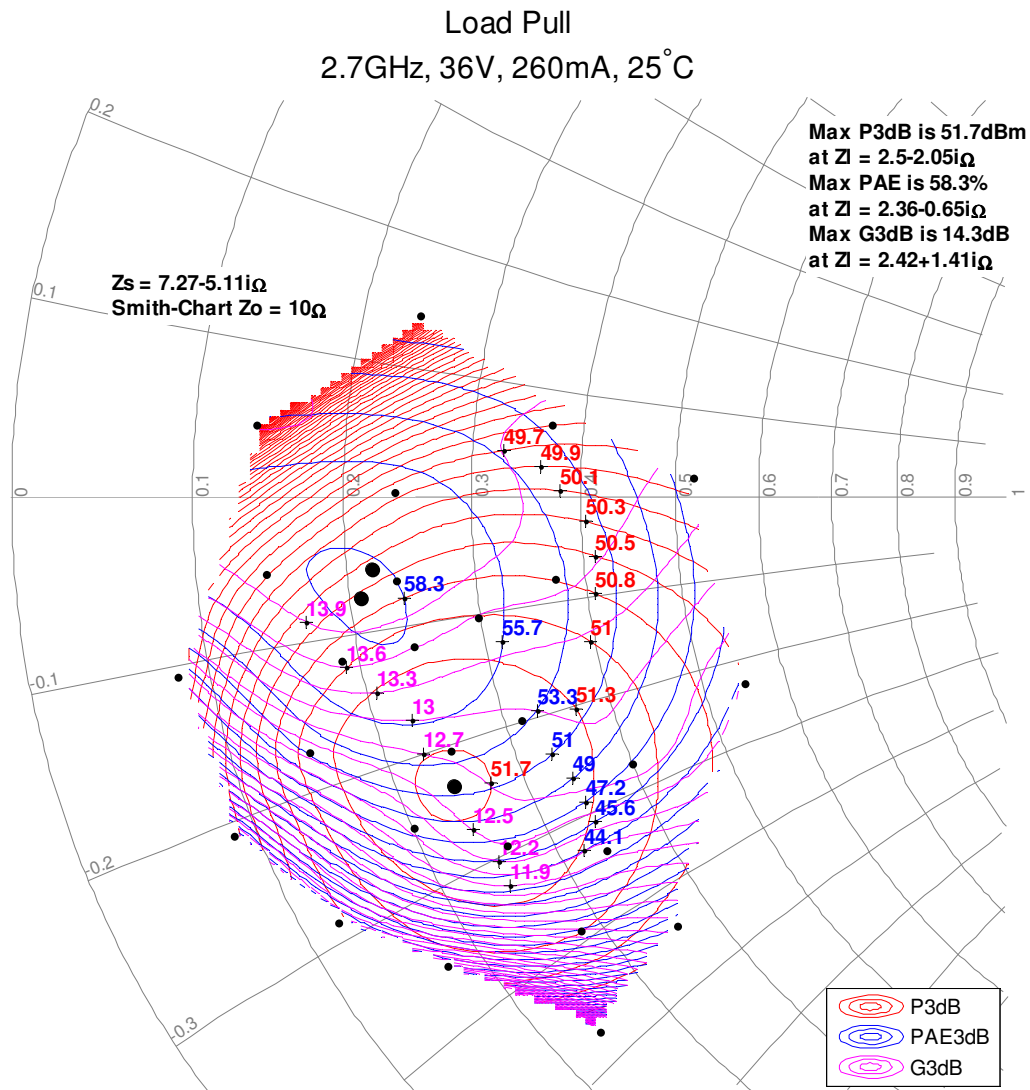

Notes:

1. Only half of device was load pulled. Load-pull reference planes are shown on page 18.
2. Load-pull condition: $V_{ds} = 36V$, $I_{dq} = 260mA$, Pulsed: 100uS pulse width, 20% duty cycle

Load Pull Smith Charts (1, 2)

RF performance that the device typically exhibits when placed in the specified impedance environment. The impedances are not the impedances of the device, they are the impedances presented to the device via an RF circuit or load-pull system. The impedances listed follow an optimized trajectory to maintain high power and high efficiency. The impedances are for one independent half of the device only.

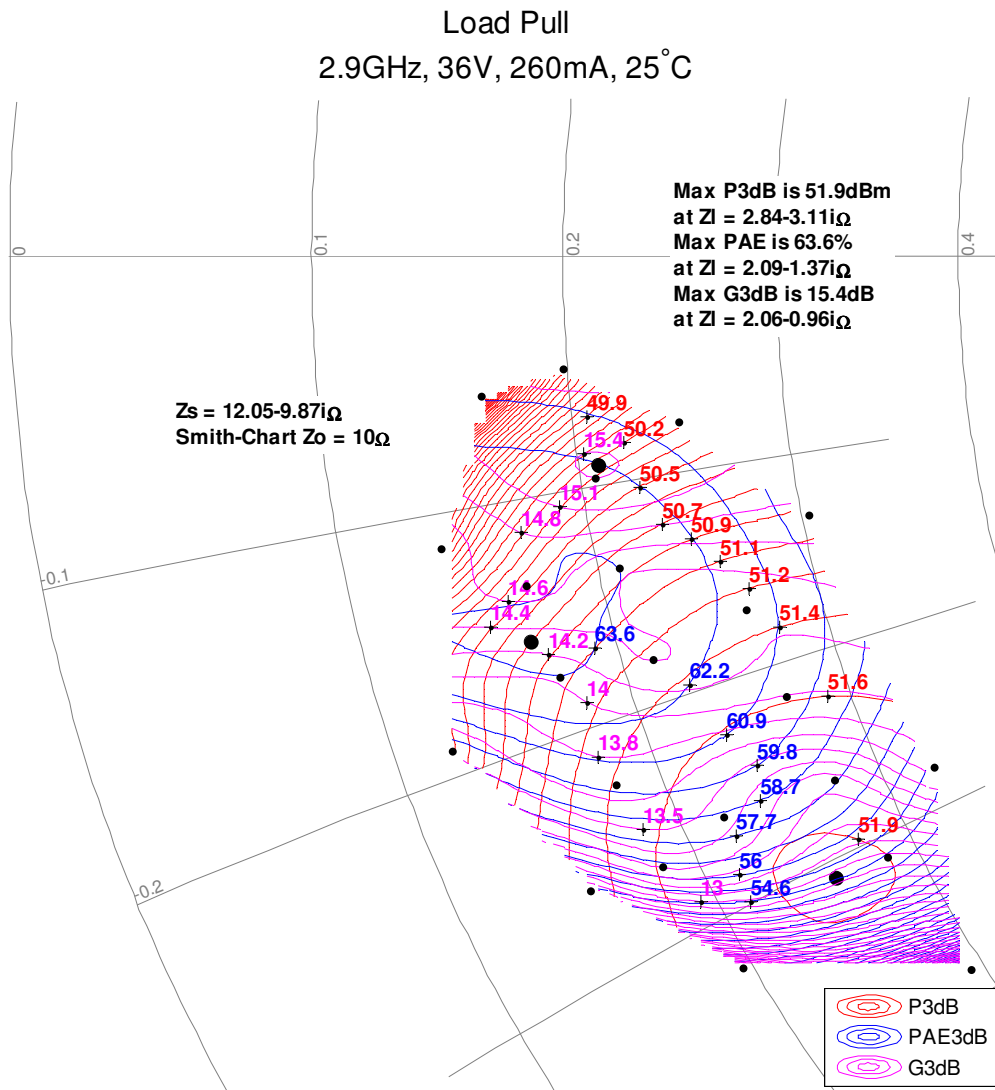

Notes:

1. Only half of device was load pulled. Load-pull reference planes are shown on page 18.
2. Load-pull condition: $V_{ds} = 36V$, $I_{dq} = 260mA$, Pulsed: 100uS pulse width, 20% duty cycle

Load Pull Smith Charts (1, 2)

RF performance that the device typically exhibits when placed in the specified impedance environment. The impedances are not the impedances of the device, they are the impedances presented to the device via an RF circuit or load-pull system. The impedances listed follow an optimized trajectory to maintain high power and high efficiency. The impedances are for one independent half of the device only.

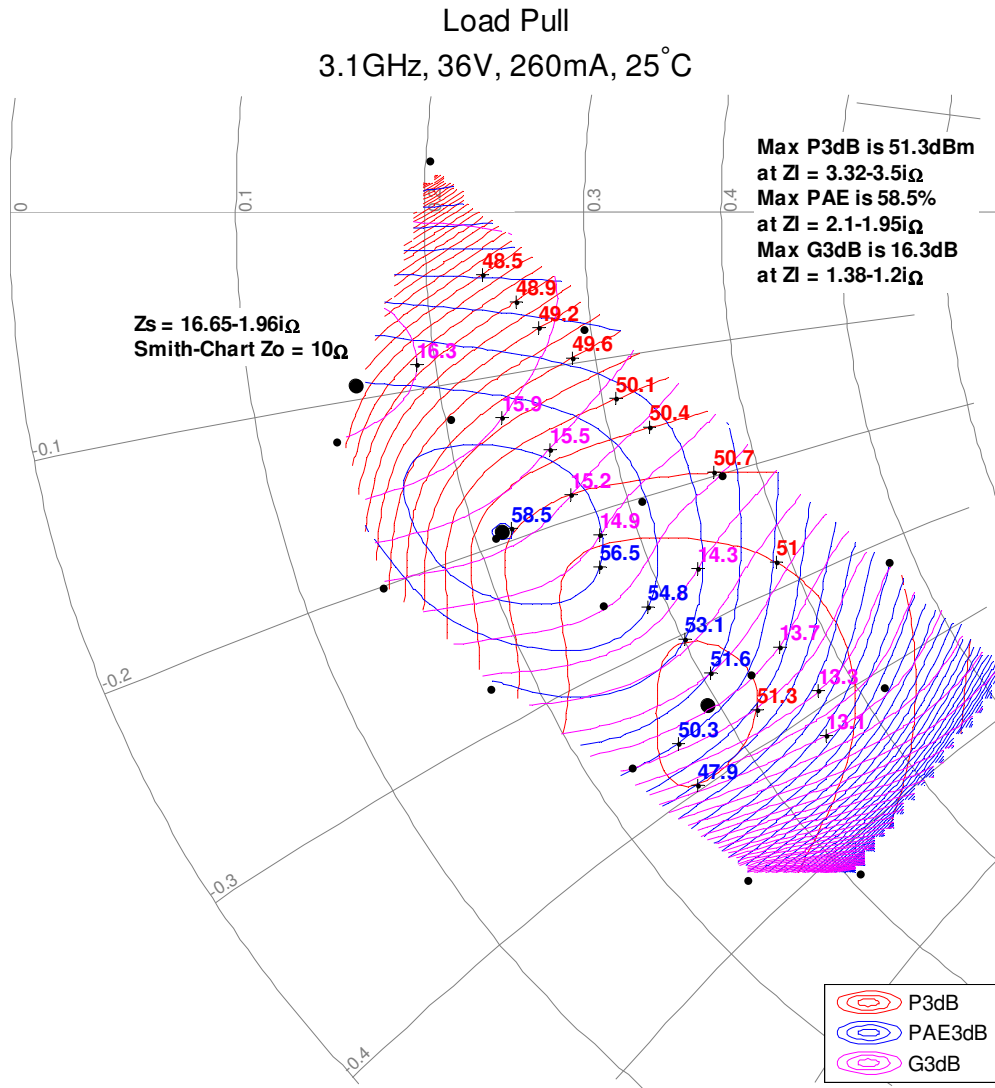

Notes:

1. Only half of device was load pulled. Load-pull reference planes are shown on page 18.
2. Load-pull condition: $V_{ds} = 36V$, $I_{dq} = 260mA$, Pulsed: 100uS pulse width, 20% duty cycle

Load Pull Smith Charts (1, 2)

RF performance that the device typically exhibits when placed in the specified impedance environment. The impedances are not the impedances of the device, they are the impedances presented to the device via an RF circuit or load-pull system. The impedances listed follow an optimized trajectory to maintain high power and high efficiency. The impedances are for one independent half of the device only.

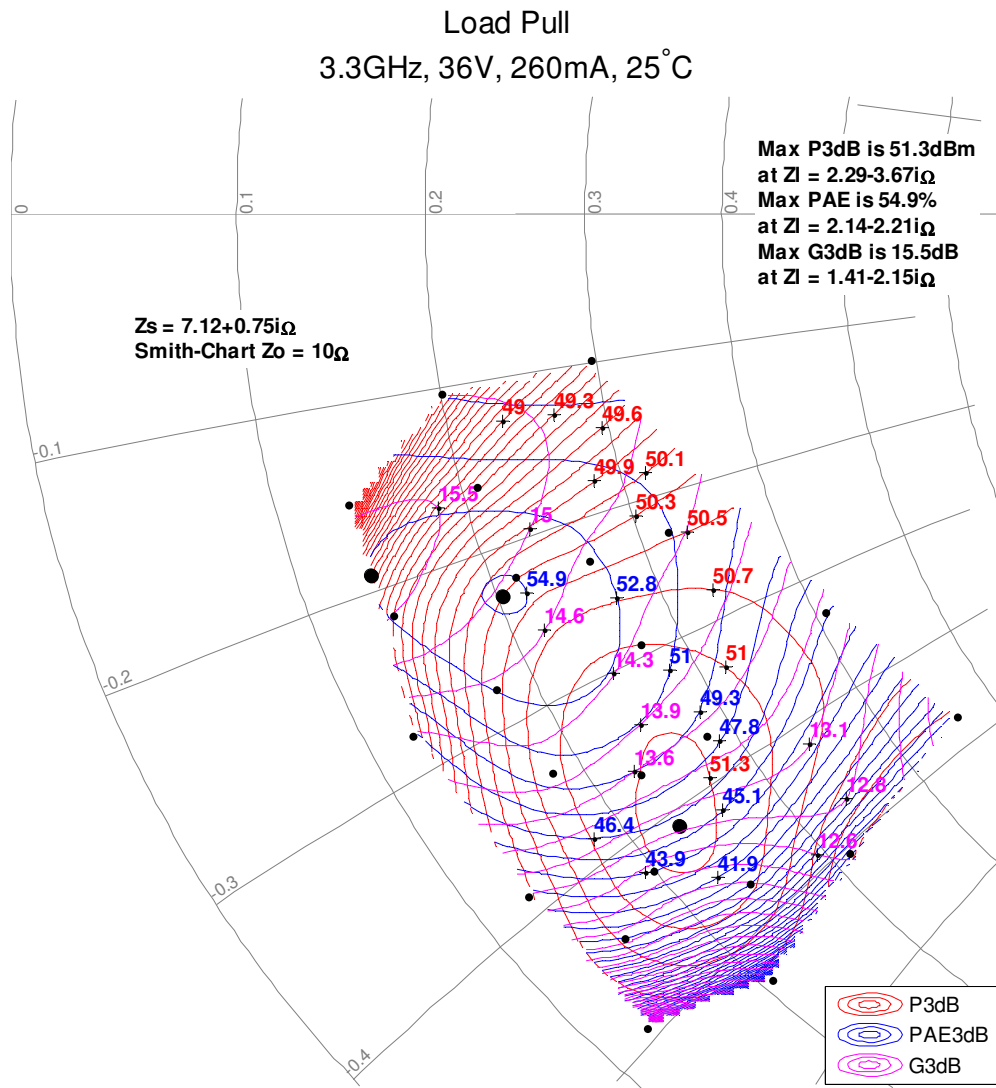

Notes:

1. Only half of device was load pulled. Load-pull reference planes are shown on page 18.
2. Load-pull condition: Vds = 36V, Idq = 260mA, Pulsed: 100uS pulse width, 20% duty cycle

Load Pull Smith Charts (1, 2)

RF performance that the device typically exhibits when placed in the specified impedance environment. The impedances are not the impedances of the device, they are the impedances presented to the device via an RF circuit or load-pull system. The impedances listed follow an optimized trajectory to maintain high power and high efficiency. The impedances are for one independent half of the device only.

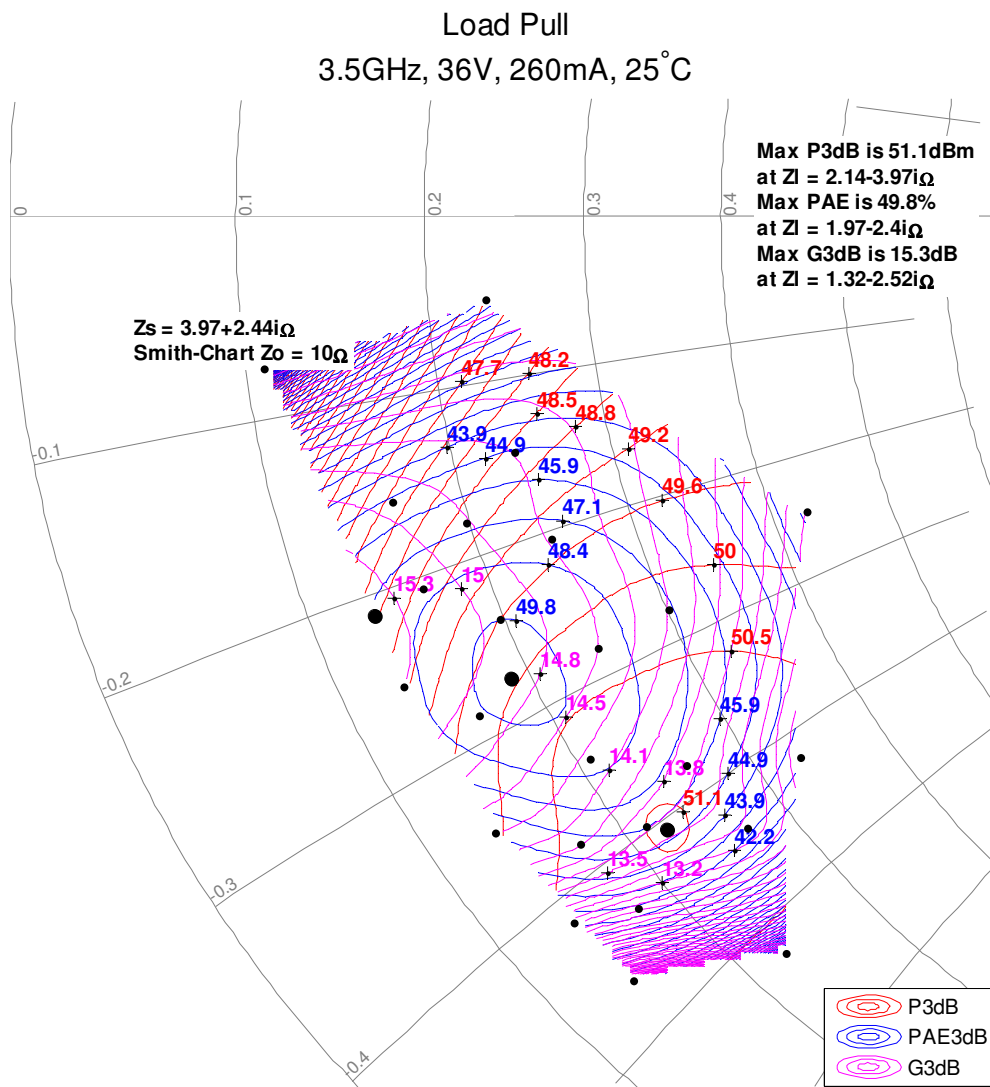

Notes:

1. Only half of device was load pulled. Load-pull reference planes are shown on page 18.
2. Load-pull condition: $V_{ds} = 36V$, $I_{dq} = 260mA$, Pulsed: 100uS pulse width, 20% duty cycle

Typical Performance^(1,2)

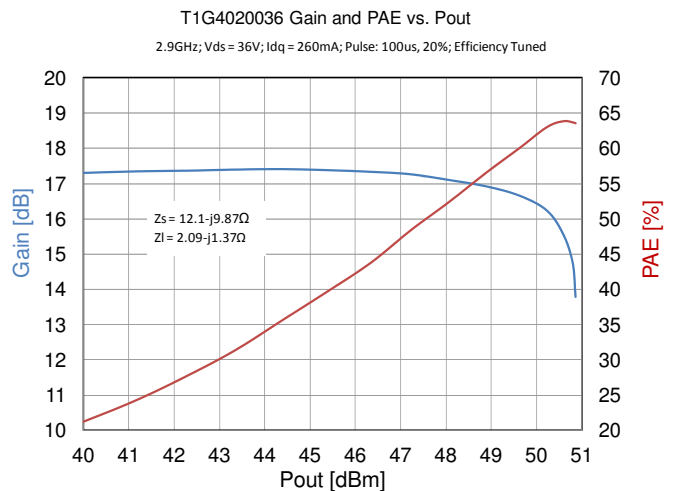
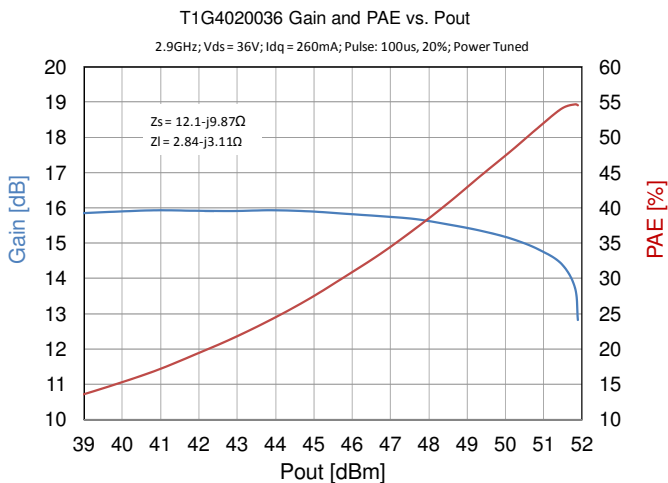
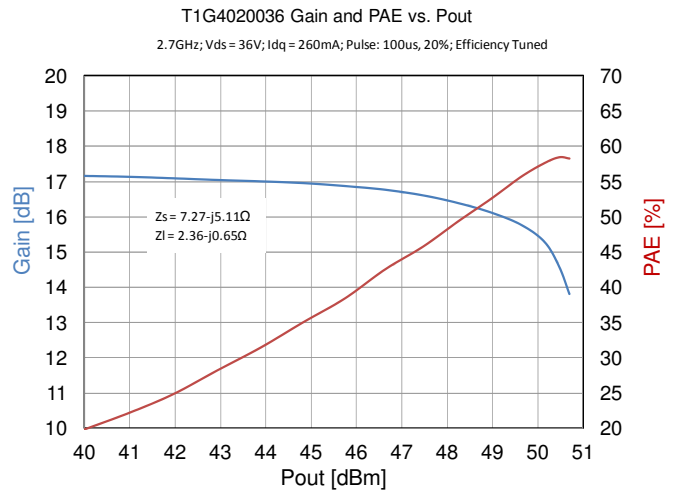
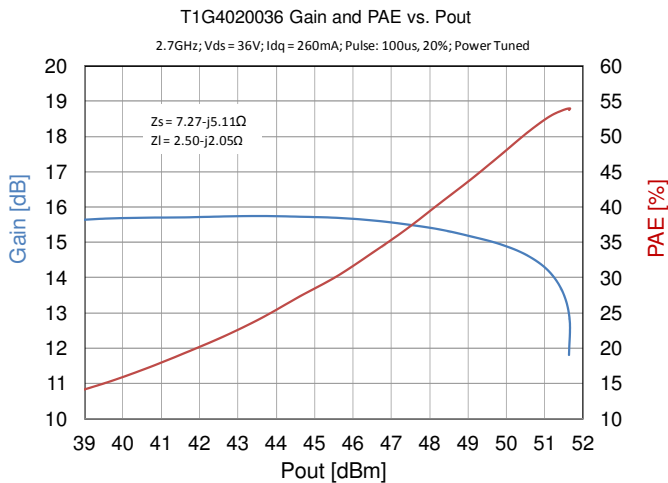

1. Only half of the device was tested. Impedances were presented at device reference planes.
2. Drive-up condition: Vds = 36V, Idq = 260mA, Pulsed: 100uS pulse width, 20% duty cycle

Typical Performance^(1,2)

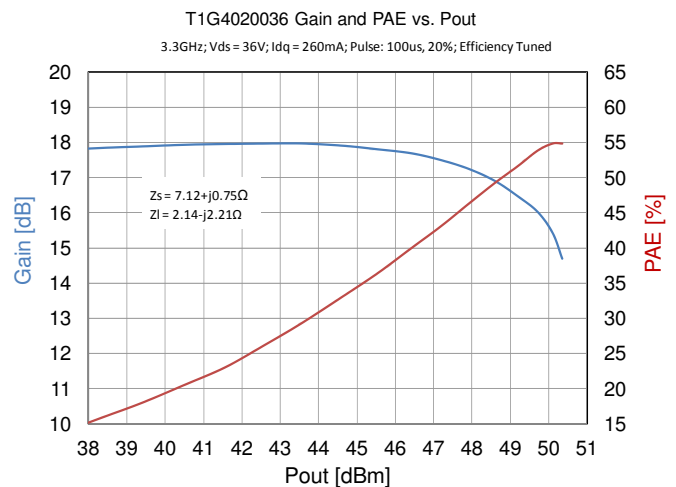
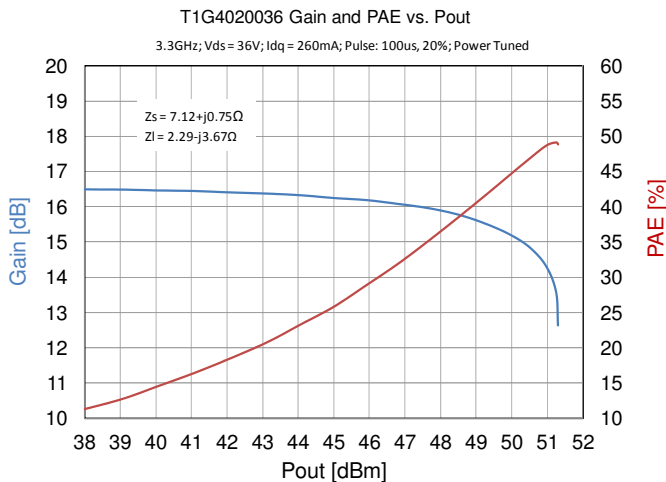
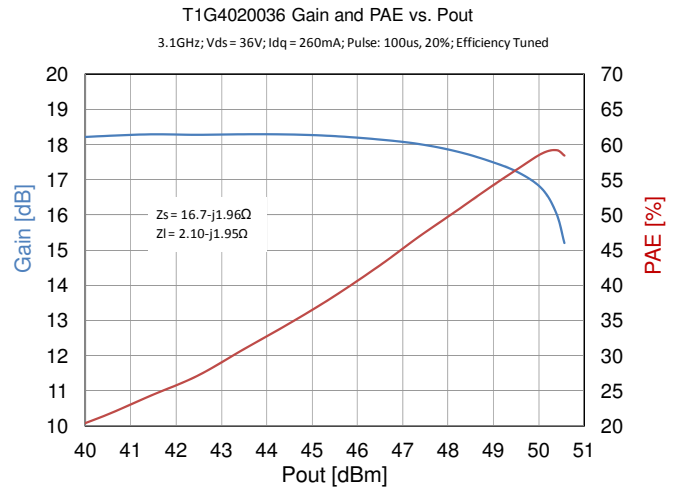
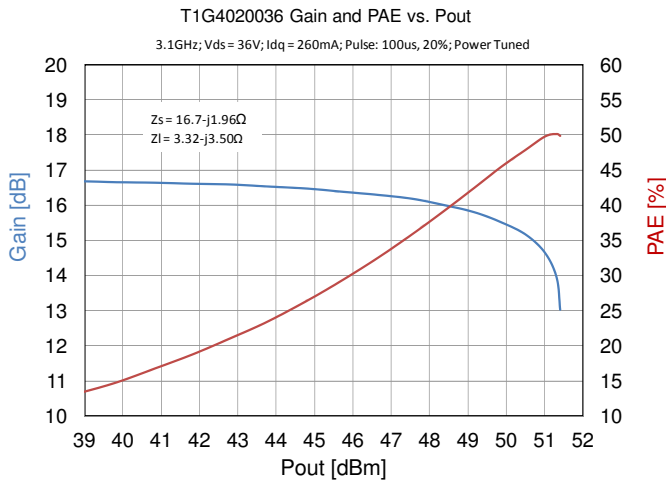

1. Only half of the device was tested. Impedances were presented at device reference planes.
2. Drive-up condition: Vds = 36V, Idq = 260mA, Pulsed: 100uS pulse width, 20% duty cycle

Typical Performance^(1,2)

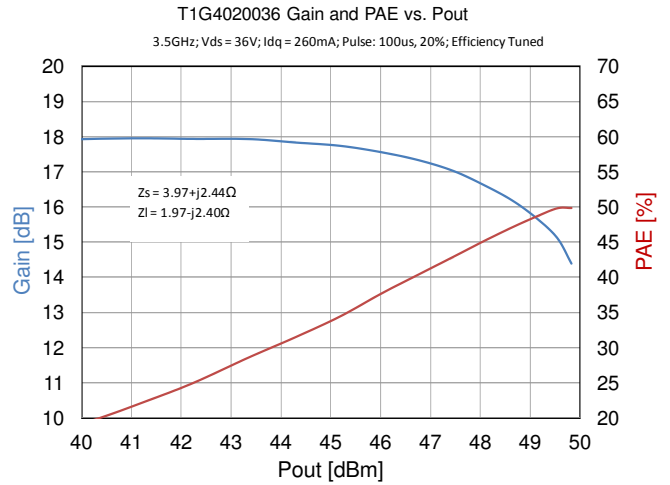
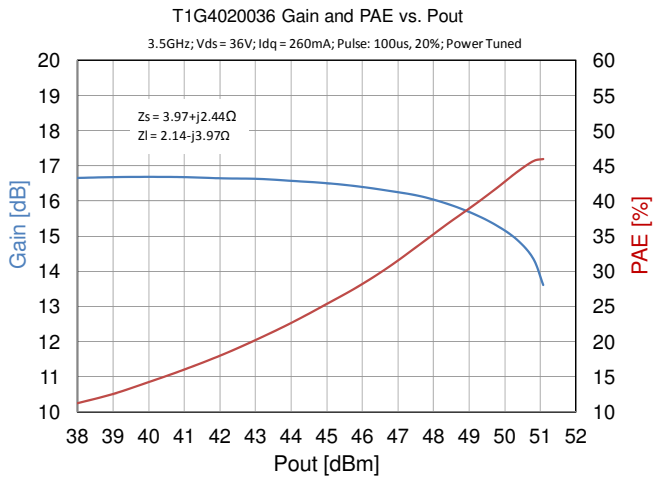

- (1) Only half of the device was tested. Impedances were presented at device reference planes.
- (2) Drive-up condition: Vds = 36V, Idq = 260mA, Pulsed: 100uS pulse width, 20% duty cycle

EVB Performance Over Temperature (1, 2)

Performance measured in TriQuint's 2.9 GHz to 3.3 GHz Evaluation Board at 3 dB compression.

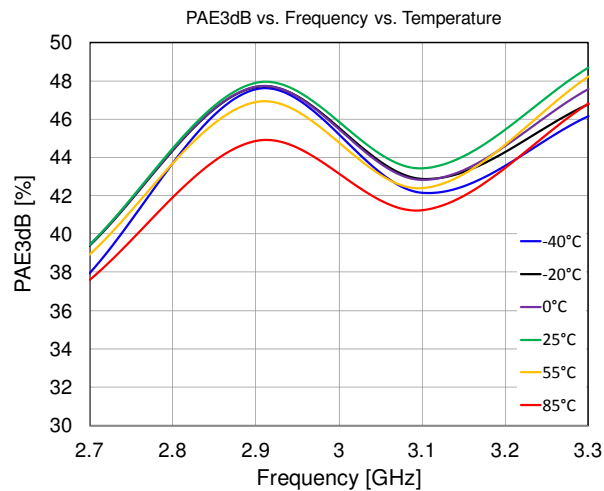
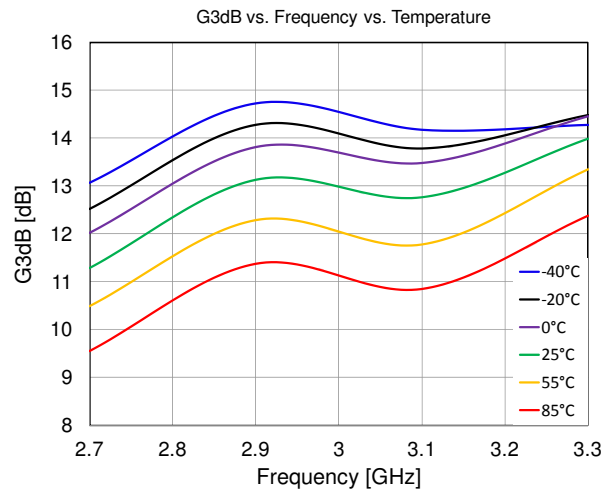
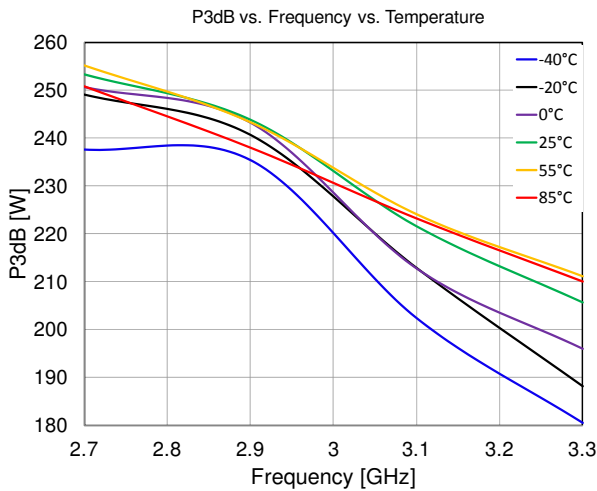

Notes:

1. Test Conditions: $V_{DS} = 36\text{ V}$, $I_{DQ} = 520\text{ mA}$
2. Test Signal: Pulse Width = 100 μs , Duty Cycle = 20%

EVB Performance Over Temperature (1, 2)

Performance measured in TriQuint's 2.9 GHz to 3.3 GHz Evaluation Board at 3 dB compression.

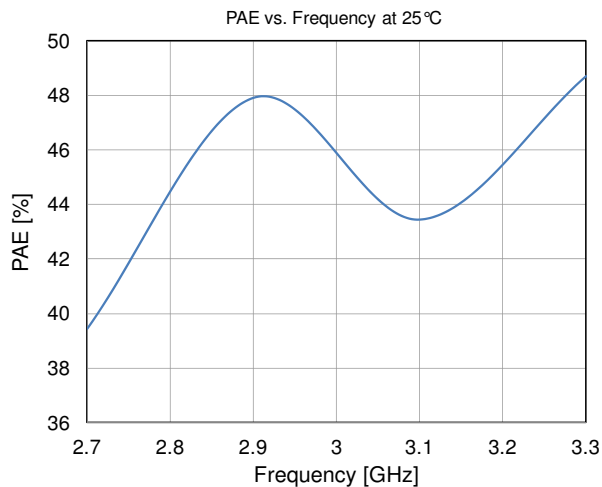
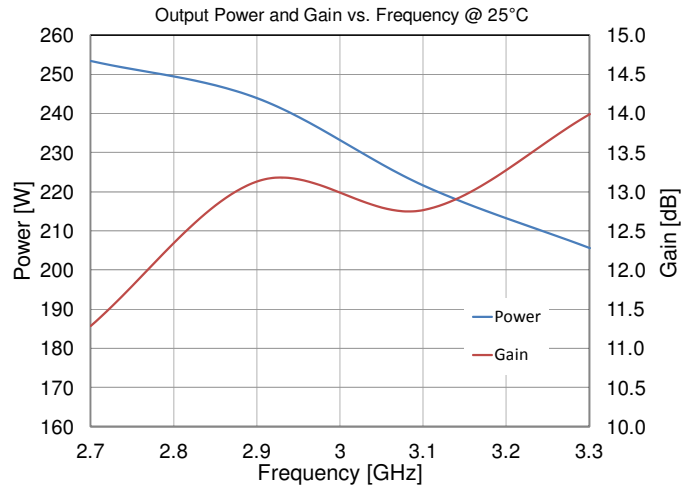

Notes:

1. Test Conditions: $V_{DS} = 36\text{ V}$, $I_{DQ} = 520\text{ mA}$
2. Test Signal: Pulse Width = 100 μs , Duty Cycle = 20%

Application Circuit

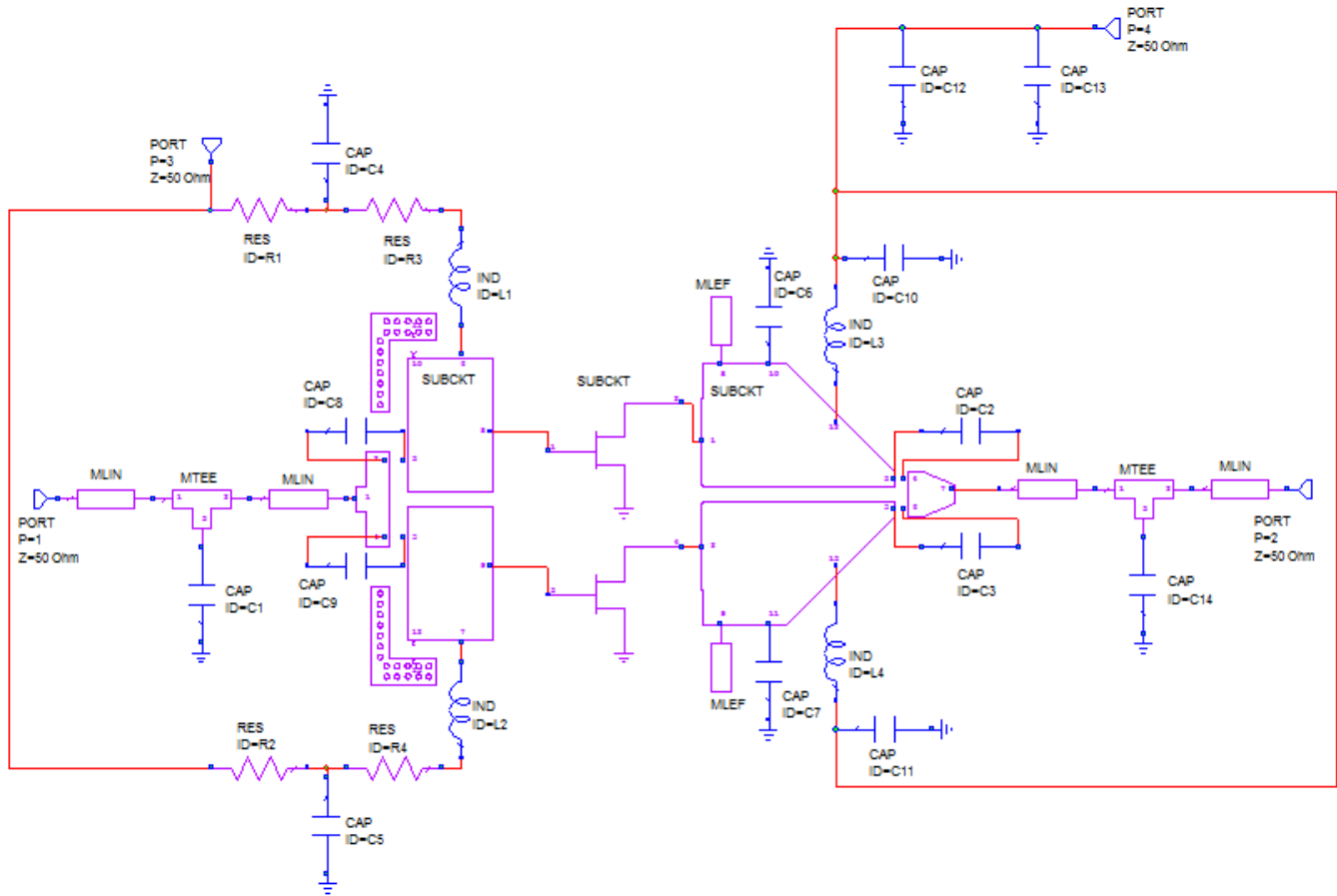

Bias-up Procedure

- Set gate voltage (V_G) to -5.0V
- Set drain voltage (V_D) to 36 V
- Slowly increase V_G until quiescent I_D is 520 mA.
- Apply RF signal

Bias-down Procedure

- Turn off RF signal
- Turn off V_D and wait 1 second to allow drain capacitor dissipation
- Turn off V_G

Evaluation Board Layout

Top RF layer is 0.020" thick Rogers RO4350B, $\epsilon_r = 3.48$. The pad pattern shown has been developed and tested for optimized assembly at TriQuint Semiconductor. The PCB land pattern has been developed to accommodate lead and package tolerances.

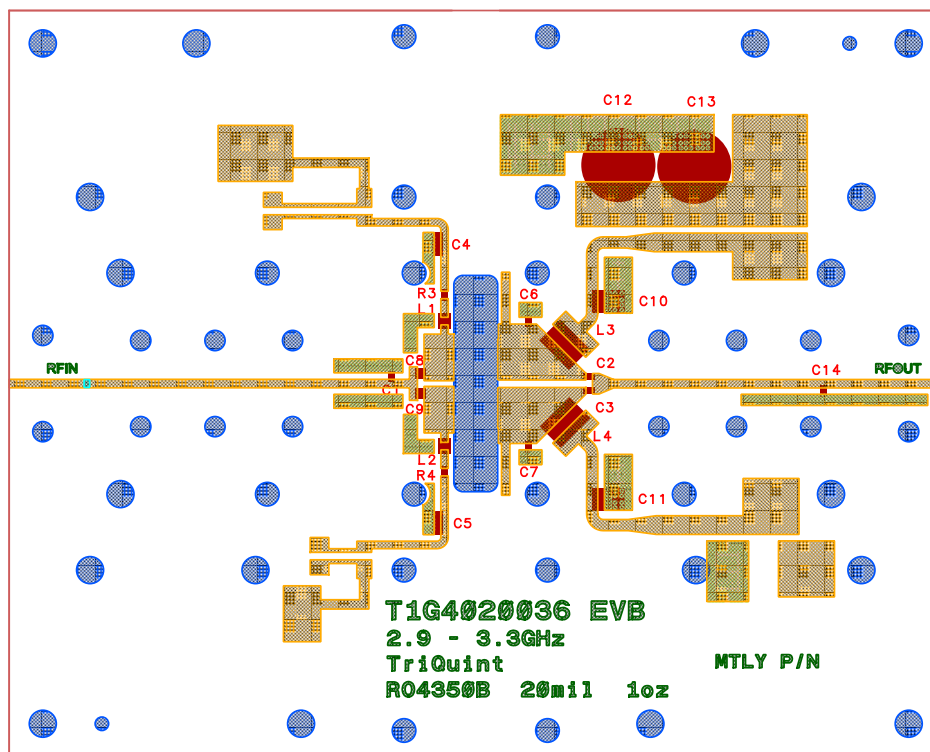

Bill of Materials

Reference Design	Value	Qty	Manufacturer	Part Number
C4, C5	10uF, 6.3V	2	TDK	C1632X5R0J106M130AC
C10, C11	1uF, 50V	2	AVX	18121C105KAT2A
C12, C13	220uF, 50V	2	United Chemi-Con	EMVY500ADA221MJA0G
C8, C9	2.7pF	2	ATC	600F2R7AT250X
C2, C3	5.6pF	2	ATC	600S5R6AT250X
C1	1.6pF	1	ATC	600S1R6AT250X
C14	0.8pF	1	ATC	600S0R8AT250X
C6, C7	0.5pF	2	ATC	600S0R5AT250X
R3, R4	10Ohms	2	Vishay	CRCW060310R0FKEA
R1, R2	0.001Ohms	2	Stackpole Electronics	CSNL1206FT1L00
L1, L2	22nH	2	Coilcraft	0805CS-220X_L
L3, L4	6.6nH	2	Coilcraft	GA3093
Connectors	SMA	2	Gigalane	1101055

Pin Layout

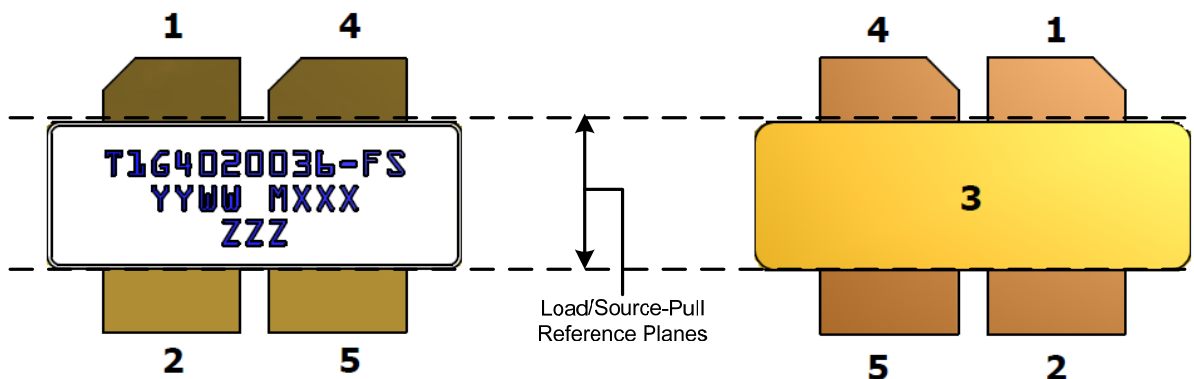

Note:

The T1G4020036-FS will be marked with the “20036” designator and a lot code marked below the part designator. The “YY” represents the last two digits of the calendar year the part was manufactured, the “WW” is the work week of the assembly lot start, the “MXXX” is the production lot number, and the “ZZZ” is an auto-generated serial number.

Pin Description

Pin	Symbol	Description
1, 4	V_D / RF OUT	Drain voltage / RF Output matched to 50 ohms; see EVB Layout on page 9 as an example.
2, 5	V_G / RF IN	Gate voltage / RF Input matched to 50 ohms; see EVB Layout on page 9 as an example.
3	Flange	Source connected to ground; see EVB Layout on page 9 as an example.

Note:

Thermal resistance measured to bottom of package

Mechanical Information

All dimensions are in inches.

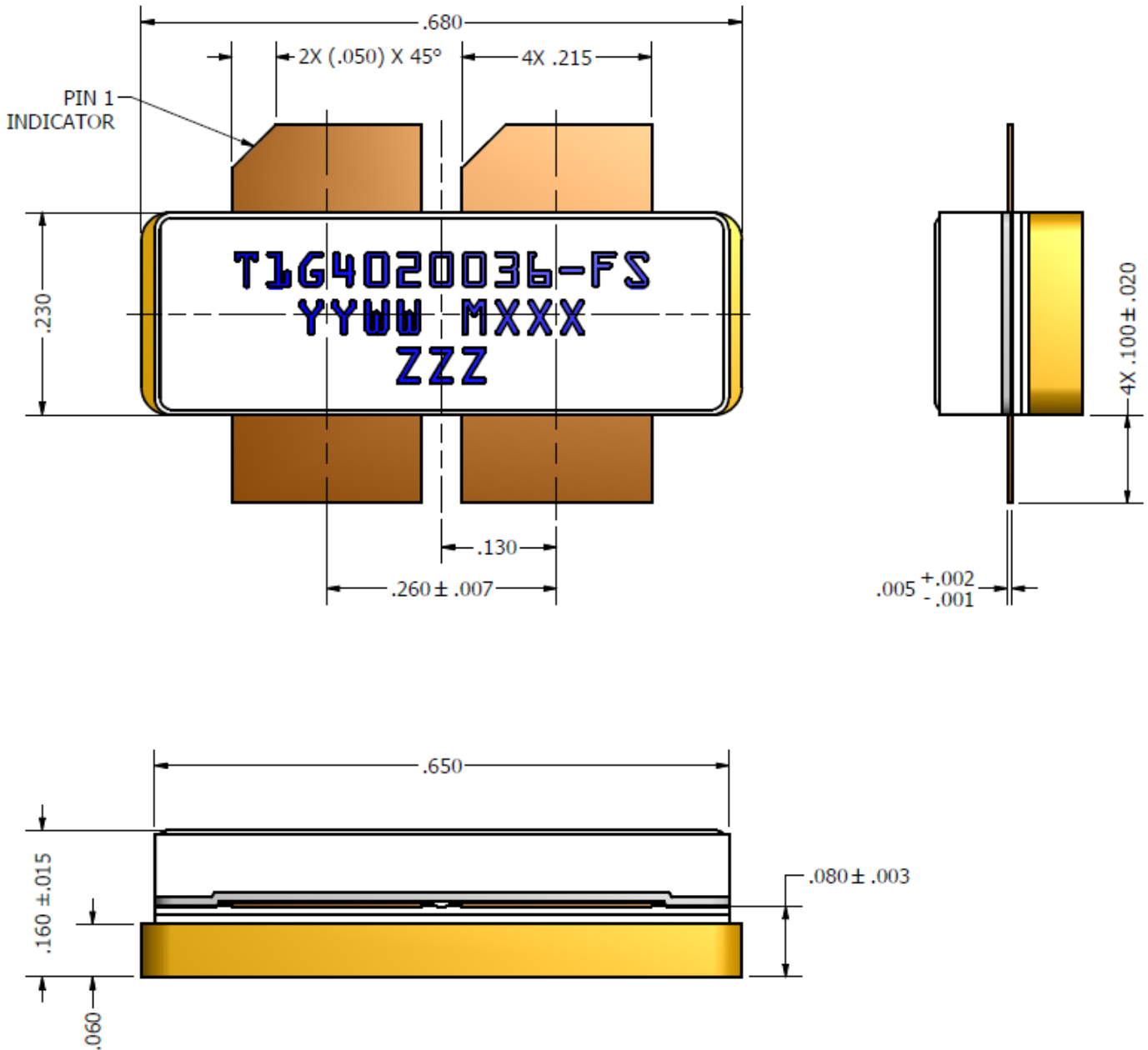

Notes:

This package is lead-free/RoHS-compliant. The plating material on the leads is NiAu. It is compatible with both lead-free and tin-lead soldering processes.

Unless otherwise noted all tolerances are ±0.005.

Product Compliance Information

ESD Sensitivity Ratings



Caution! ESD-Sensitive Device

ESD Rating: Class 1B
 Value: Passes $\geq 950V$ min.
 Test: Human Body Model (HBM)
 Standard: JEDEC Standard JESD22-A114

MSL Rating

The part is rated Moisture Sensitivity Level 3 at 260°C per JEDEC standard IPC/JEDEC J-STD-020.

ECCN

US Department of Commerce EAR99

Solderability

Compatible with the latest version of J-STD-020, Lead free solder, 260°C

RoHS Compliance

This part is compliant with EU 2002/95/EC RoHS directive (Restrictions on the Use of Certain Hazardous Substances in Electrical and Electronic Equipment).

This product also has the following attributes:

- Lead Free
- Halogen Free (Chlorine, Bromine)
- Antimony Free
- TBBP-A (C₁₅H₁₂Br₄O₂) Free
- PFOS Free
- SVHC Free

Recommended Soldering Temperature Profile

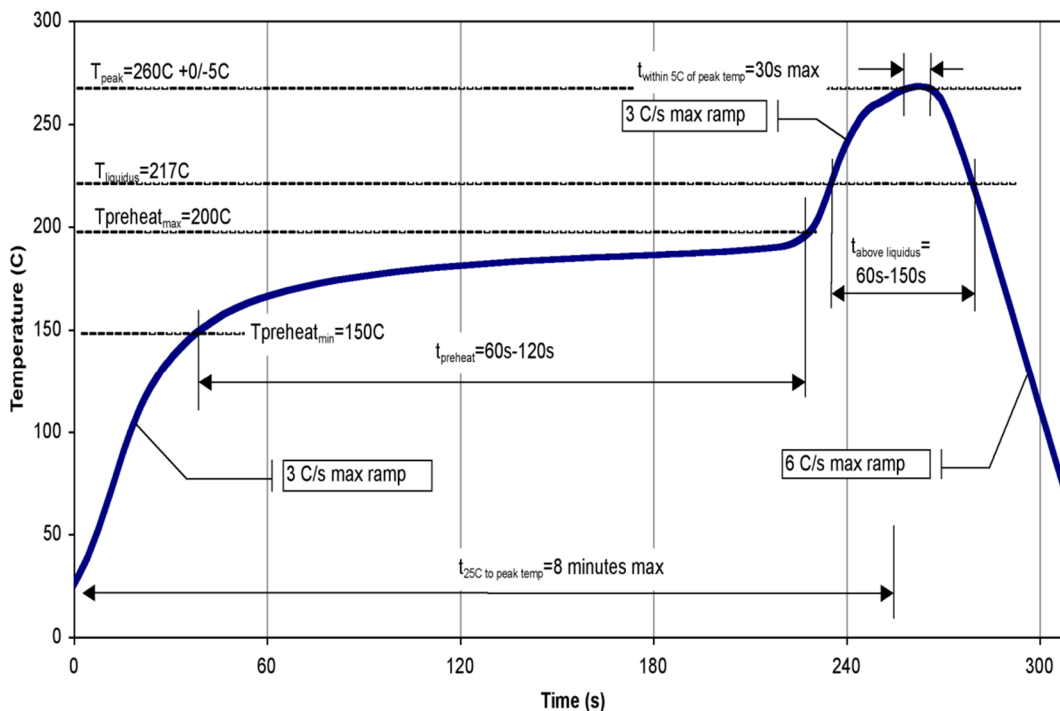

Contact Information

For the latest specifications, additional product information, worldwide sales and distribution locations, and information about TriQuint:

Web: www.triquint.com

Tel: +1.972.994.8465

Email: info-sales@triquint.com

Fax: +1.972.994.8504

For technical questions and application information:

Email: info-products@triquint.com

Important Notice

The information contained herein is believed to be reliable. TriQuint makes no warranties regarding the information contained herein. TriQuint assumes no responsibility or liability whatsoever for any of the information contained herein. TriQuint assumes no responsibility or liability whatsoever for the use of the information contained herein. The information contained herein is provided "AS IS, WHERE IS" and with all faults, and the entire risk associated with such information is entirely with the user. All information contained herein is subject to change without notice. Customers should obtain and verify the latest relevant information before placing orders for TriQuint products. The information contained herein or any use of such information does not grant, explicitly or implicitly, to any party any patent rights, licenses, or any other intellectual property rights, whether with regard to such information itself or anything described by such information.

TriQuint products are not warranted or authorized for use as critical components in medical, life-saving, or life-sustaining applications, or other applications where a failure would reasonably be expected to cause severe personal injury or death.