



### General Description

The MIC5233 is a 100mA highly accurate, low dropout regulator with high input voltage and ultra-low ground current. This combination of high voltage and low ground current makes the MIC5233 ideal for multi-cell Li-Ion battery systems.

A  $\mu$ Cap LDO design, the MIC5233 is stable with either ceramic or tantalum output capacitor. It only requires a 2.2 $\mu$ F capacitor for stability.

Features of the MIC5233 include enable input, thermal shutdown, current limit, reverse battery protection, and reverse leakage protection.

Available in fixed and adjustable output voltage versions, the MIC5233 is offered in the IttyBitty™ SOT-23-5 package with a junction temperature range of  $-40^{\circ}\text{C}$  to  $+125^{\circ}\text{C}$ .

### Features

- Wide input voltage range: 2.3V to 36V
- Ultra low ground current: 18 $\mu$ A
- Low dropout voltage of 270mV at 100mA
- High output accuracy of  $\pm 2.0\%$  over temperature
- $\mu$ Cap: stable with ceramic or tantalum capacitors
- Excellent line and load regulation specifications
- Zero shutdown current
- Reverse battery protection
- Reverse leakage protection
- Thermal shutdown and current limit protection
- IttyBitty™ SOT-23-5 package

### Applications

- Keep-alive supply in notebook and portable computers
- USB power supply
- Logic supply for high-voltage batteries
- Automotive electronics
- Battery powered systems
- 3-4 cell Li-Ion battery input range

### Ordering Information

Part Number	Marking	Voltage	Junction Temp. Range	Package
MIC5233-1.8BM5	L318	1.8V	$-40^{\circ}\text{C}$ to $+125^{\circ}\text{C}$	SOT-23-5
MIC5233-2.5BM5	L325	2.5V	$-40^{\circ}\text{C}$ to $+125^{\circ}\text{C}$	SOT-23-5
MIC5233-3.0BM5	L330	3.0V	$-40^{\circ}\text{C}$ to $+125^{\circ}\text{C}$	SOT-23-5
MIC5233-3.3BM5	L333	3.3V	$-40^{\circ}\text{C}$ to $+125^{\circ}\text{C}$	SOT-23-5
MIC5233-5.0BM5	L350	5.0V	$-40^{\circ}\text{C}$ to $+125^{\circ}\text{C}$	SOT-23-5
MIC5233BM5	L3AA	ADJ.	$-40^{\circ}\text{C}$ to $+125^{\circ}\text{C}$	SOT-23-5

### Typical Application

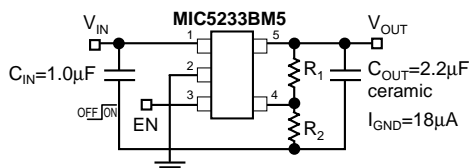

#### Ultra-Low Current Adjustable Regulator Application

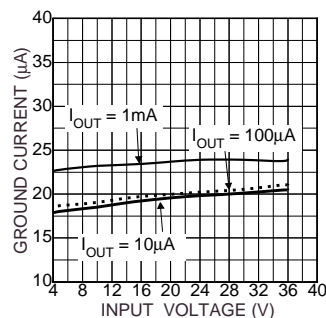

Ground Current vs. Input Voltage

## Pin Configuration

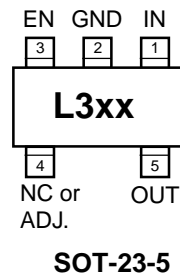

## Pin Description

SOT-23-5	Pin Name	Pin Function
1	IN	Supply Input.
2	GND	Ground.
3	EN	Enable (Input): Logic low = shutdown; logic high = enable
4	NC (fixed)	No Connect.
	ADJ (ADJ.)	Adjust (Input): Feedback input. Connect to resistive voltage-divider network.
5	OUT	Regulator Output.

**Absolute Maximum Ratings (Note 1)**

Input Supply Voltage .....	-20V to 38V
Enable Input Voltage .....	-0.3V to 38V
Power Dissipation .....	Internally Limited
Junction Temperature .....	-40°C to +125°C
Storage Temperature .....	-65°C to +150°C
ESD Rating, <b>Note 3</b>	

**Operating Ratings (Note 2)**

Input Supply Voltage .....	2.3V to 36V
Enable Input Voltage .....	0V to 36V
Junction Temperature (T <sub>J</sub> ) .....	-40°C to +125°C
Package Thermal Resistance	
SOT-23-5 (θ <sub>JA</sub> ) .....	235°C/W

**Electrical Characteristics (Note 4)**

T<sub>A</sub> = 25°C with V<sub>IN</sub> = V<sub>OUT</sub> + 1V; I<sub>OUT</sub> = 100μA; V<sub>EN</sub> ≥ 2V; **Bold** values indicate -40°C < T<sub>J</sub> < +125°C; unless otherwise specified.

Parameter	Condition	Min	Typ	Max	Units
Output Voltage Accuracy	Variation from nominal V <sub>OUT</sub>	-1.0		+1.0	%
		<b>-2.0</b>		<b>+2.0</b>	%
Line Regulation	V <sub>IN</sub> = V <sub>OUT</sub> + 1V to 36V		0.04	0.5	%
Load Regulation	I <sub>OUT</sub> = 100μA to 100mA		0.25	1	%
Dropout Voltage	I <sub>OUT</sub> = 100μA		50		mV
	I <sub>OUT</sub> = 50mA		230	300	mV
				<b>400</b>	mV
	I <sub>OUT</sub> = 100mA		270	400	mV
				<b>450</b>	mV
Ground Current	I <sub>OUT</sub> = 100μA		18	30	μA
	I <sub>OUT</sub> = 50mA		0.35	0.70	mA
	I <sub>OUT</sub> = 100mA		1	2	mA
Ground Current in Shutdown	V <sub>EN</sub> ≤ 0.6V; V <sub>IN</sub> = 36V		0.1	1	μA
Short Circuit Current	V <sub>OUT</sub> = 0V		190	<b>350</b>	mA
Output Leakage, Reverse Polarity Input	Load = 500Ω; V <sub>IN</sub> = -15V		-0.1		μA

**Enable Input**

Input Low Voltage	Regulator OFF			<b>0.6</b>	V
Input High Voltage	Regulator ON	<b>2.0</b>			V
Enable Input Current	V <sub>EN</sub> = 0.6V; Regulator OFF	-1.0	0.01	1.0	μA
	V <sub>EN</sub> = 2.0V; Regulator ON		0.1	1.0	μA
	V <sub>EN</sub> = 36V; Regulator ON		0.5	2.5	μA

**Note 1.** Exceeding the absolute maximum rating may damage the device.

**Note 2.** The device is not guaranteed to function outside its operating rating.

**Note 3.** Devices are ESD sensitive. Handling precautions recommended. Human body model, 1.5k in series with 100pF.

**Note 4.** Specification for packaged product only.

# Typical Characteristics

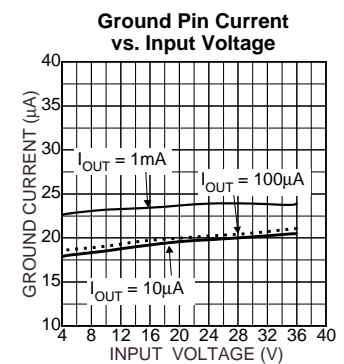
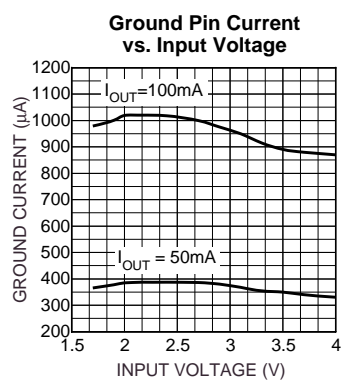
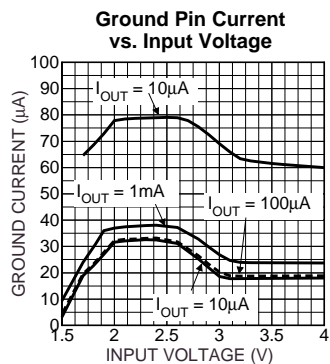
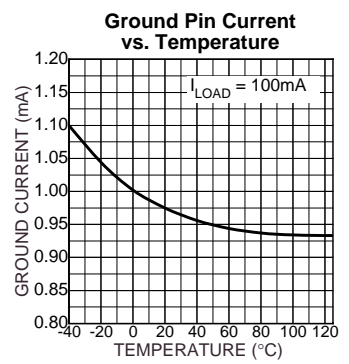
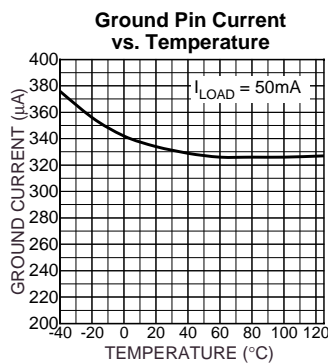
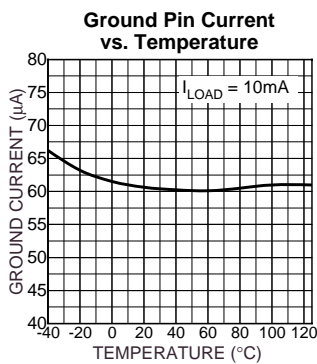
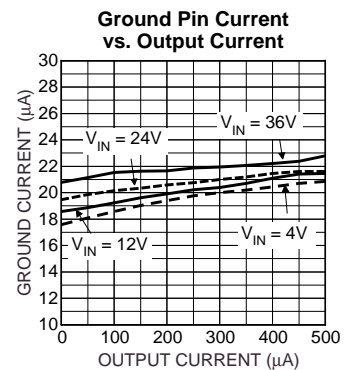
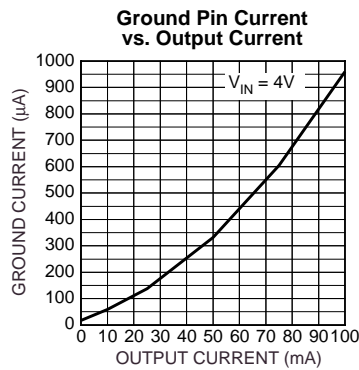
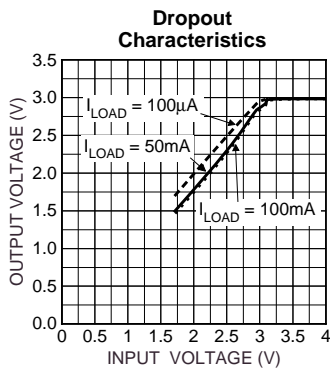
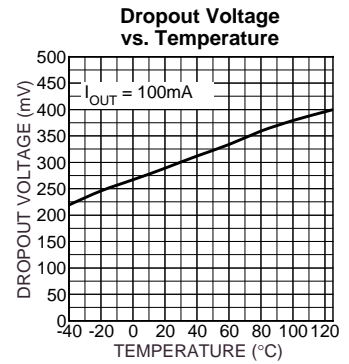
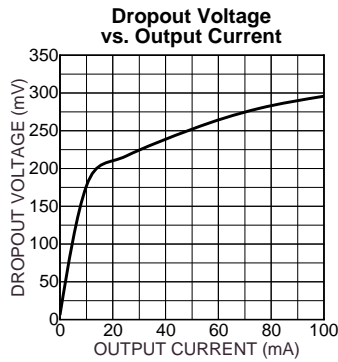
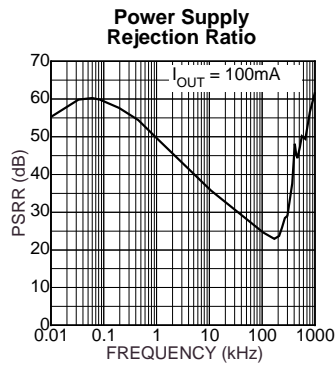

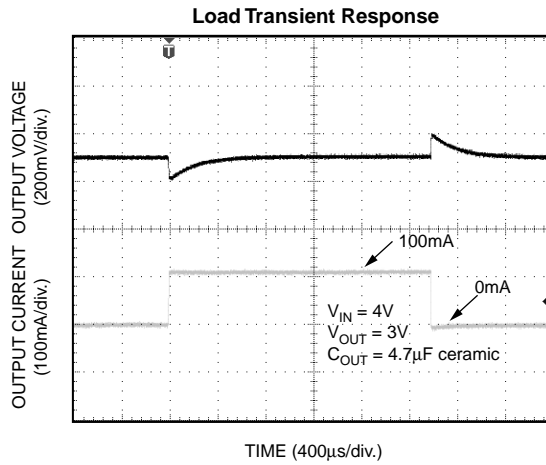
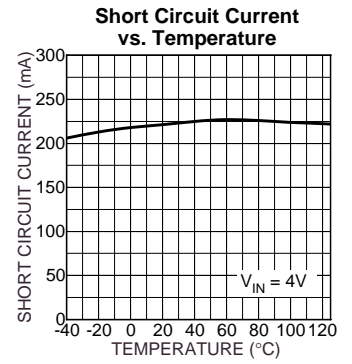
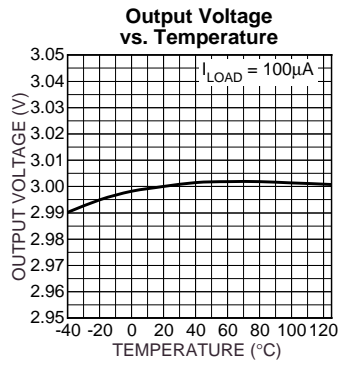
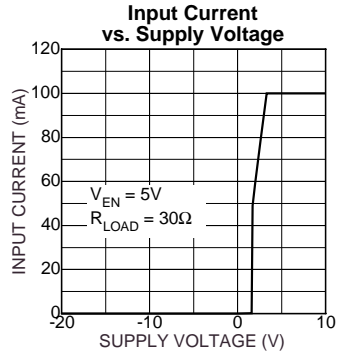

## Functional Diagrams

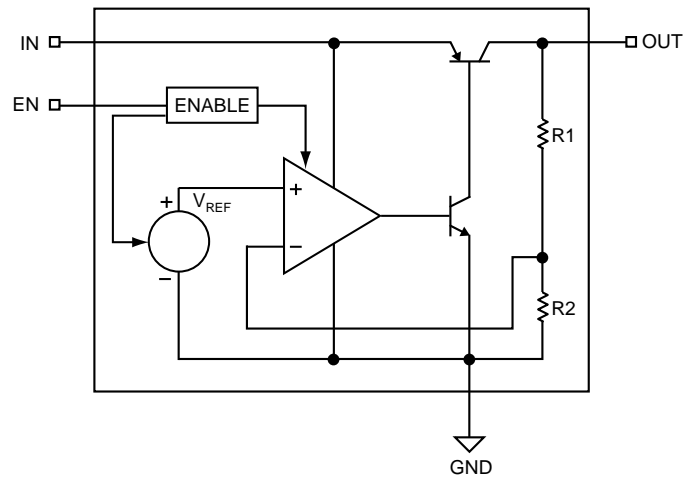

**Block Diagram – Fixed Output Voltage**

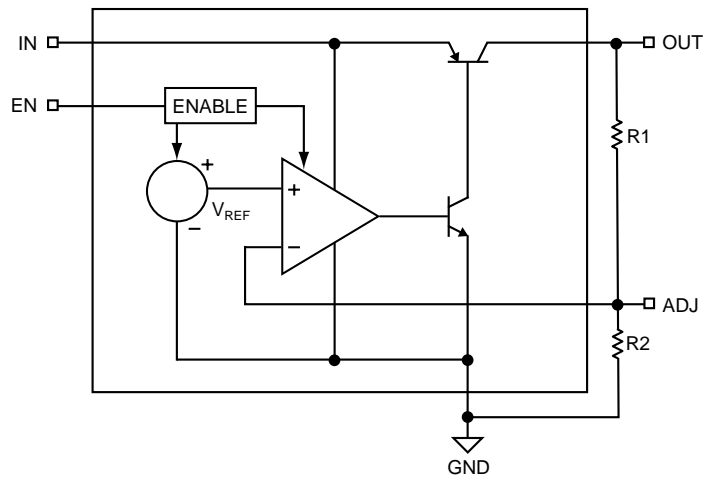

**Block Diagram – Adjustable Output Voltage**

## Applications Information

### Enable/Shutdown

The MIC5233 comes with an active-high enable pin that allows the regulator to be disabled. Forcing the enable pin low disables the regulator and sends it into a “zero” off-mode-current state. In this state, current consumed by the regulator goes nearly to zero. Forcing the enable pin high enables the output voltage.

### Input Capacitor

The MIC5233 has high input voltage capability up to 36V. The input capacitor must be rated to sustain voltages that may be used on the input. An input capacitor may be required when the device is not near the source power supply or when supplied by a battery. Small, surface mount, ceramic capacitors can be used for bypassing. A larger value may be required if the source supply has high ripple.

### Output Capacitor

The MIC5233 requires an output capacitor for stability. The design requires 2.2 $\mu$ F or greater on the output to maintain stability. The design is optimized for use with low-ESR ceramic chip capacitors. High-ESR capacitors may cause high frequency oscillation. The maximum recommended ESR is 3 $\Omega$ . The output capacitor can be increased without limit. Larger valued capacitors help to improve transient response.

X7R/X5R dielectric-type ceramic capacitors are recommended because of their temperature performance. X7R-type capacitors change capacitance by 15% over their operating temperature range and are the most stable type of ceramic capacitors. Z5U and Y5V dielectric capacitors change value by as much as 50% and 60% respectively over their operating temperature ranges. To use a ceramic chip capacitor with Y5V dielectric, the value must be much higher than an X7R ceramic capacitor to ensure the same minimum capacitance over the equivalent operating temperature range.

### No-Load Stability

The MIC5233 will remain stable and in regulation with no load unlike many other voltage regulators. This is especially important in CMOS RAM keep-alive applications.

### Thermal Consideration

The MIC5233 is designed to provide 100mA of continuous current in a very small package. Maximum power dissipation can be calculated based on the output current and the voltage drop across the part. To determine the maximum power dissipation of the package, use the junction-to-ambient thermal resistance of the device and the following basic equation:

$$P_{D(MAX)} = \left( \frac{T_{J(MAX)} - T_A}{\theta_{JA}} \right)$$

$T_{J(MAX)}$  is the maximum junction temperature of the die, 125°C, and  $T_A$  is the ambient operating temperature.  $\theta_{JA}$  is layout dependent; Table 1 shows examples of the junction-to-ambient thermal resistance for the MIC5233.

Package	$\theta_{JA}$ Recommended Minimum Footprint
SOT-23-5	235°C/W

**Table 1. SOT-23-5 Thermal Resistance**

The actual power dissipation of the regulator circuit can be determined using the equation:

$$P_D = (V_{IN} - V_{OUT})I_{OUT} + V_{IN} \times I_{GND}$$

Substituting  $P_{D(MAX)}$  for  $P_D$  and solving for the operating conditions that are critical to the application will give the maximum operating conditions for the regulator circuit. For example, when operating the MIC5233-3.0BM5 at 50°C with a minimum footprint layout, the maximum input voltage for a set output current can be determined as follows:

$$P_{D(MAX)} = \left( \frac{125^\circ\text{C} - 50^\circ\text{C}}{235^\circ\text{C/W}} \right)$$

$$P_{D(MAX)} = 319\text{mW}$$

The junction-to-ambient ( $\theta_{JA}$ ) thermal resistance for the minimum footprint is 235°C/W, from Table 1. It is important that the maximum power dissipation not be exceeded to ensure proper operation. Since the MIC5233 was designed to operate with high input voltages, careful consideration must be given so as not to overheat the device. With very high input-to-output voltage differentials, the output current is limited by the total power dissipation. Total power dissipation is calculated using the following equation:

$$P_D = (V_{IN} - V_{OUT})I_{OUT} + V_{IN} \times I_{GND}$$

Due to the potential for input voltages up to 36V, ground current must be taken into consideration.

If we know the maximum load current, we can solve for the maximum input voltage using the maximum power dissipation calculated for a 50°C ambient, 319mW.

$$P_{D(MAX)} = (V_{IN} - V_{OUT})I_{OUT} + V_{IN} \times I_{GND}$$

$$319\text{mW} = (V_{IN} - 3\text{V})100\text{mA} + V_{IN} \times 2.8\text{mA}$$

Ground pin current is estimated using the typical characteristics of the device.

$$619\text{mW} = V_{IN} (102.8\text{mA})$$

$$V_{IN} = 6.02\text{V}$$

For higher current outputs only a lower input voltage will work for higher ambient temperatures.

Assuming a lower output current of 10mA, the maximum input voltage can be recalculated:

$$319\text{mW} = (V_{IN} - 3\text{V})10\text{mA} + V_{IN} \times 0.1\text{mA}$$

$$349\text{mW} = V_{IN} \times 10.1\text{mA}$$

$$V_{IN} = 34.9\text{V}$$

Maximum input voltage for a 10mA load current at 50°C ambient temperature is 34.9V, utilizing virtually the entire operating voltage range of the device.

### Adjustable Regulator Application

The MIC5233BM5 can be adjusted from 1.24V to 20V by using two external resistors (Figure 1). The resistors set the output voltage based on the following equation:

$$V_{\text{OUT}} = V_{\text{REF}} \left( 1 + \left( \frac{R_1}{R_2} \right) \right)$$

Where  $V_{\text{REF}} = 1.24\text{V}$ .

Feedback resistor R2 should be no larger than 300k $\Omega$ .

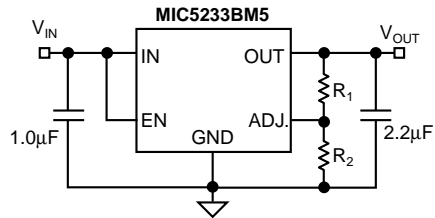

**Figure 1. Adjustable Voltage Application**



**Package Information**

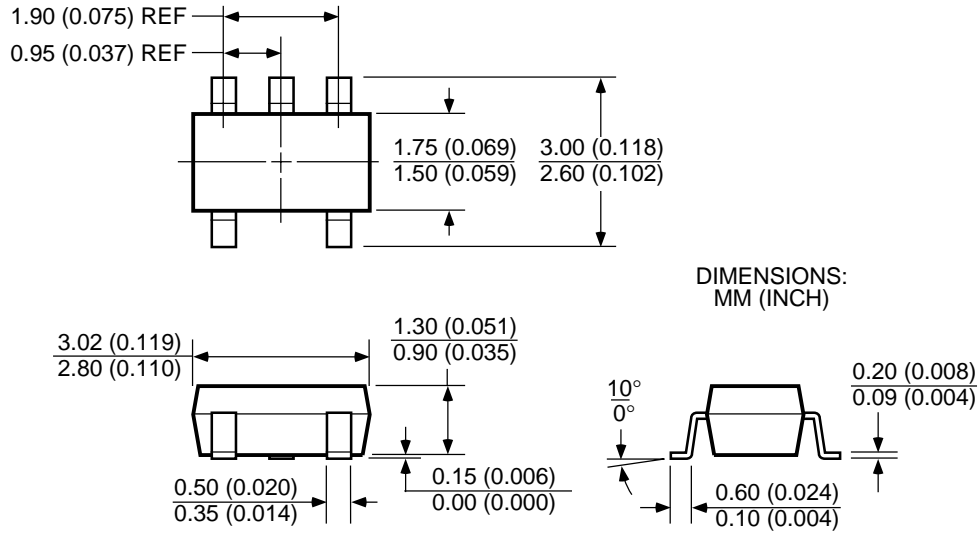

**SOT-23-5 (M5)**

**MICREL, INC. 1849 FORTUNE DRIVE SAN JOSE, CA 95131 USA**

TEL + 1 (408) 944-0800 FAX + 1 (408) 944-0970 WEB <http://www.micrel.com>

The information furnished by Micrel in this datasheet is believed to be accurate and reliable. However, no responsibility is assumed by Micrel for its use. Micrel reserves the right to change circuitry and specifications at any time without notification to the customer.

Micrel Products are not designed or authorized for use as components in life support appliances, devices or systems where malfunction of a product can reasonably be expected to result in personal injury. Life support devices or systems are devices or systems that (a) are intended for surgical implant into the body or (b) support or sustain life, and whose failure to perform can be reasonably expected to result in a significant injury to the user. A Purchaser's use or sale of Micrel Products for use in life support appliances, devices or systems is at Purchaser's own risk and Purchaser agrees to fully indemnify Micrel for any damages resulting from such use or sale.

© 2003 Micrel, Incorporated.