

ANT-418-MHW-xxx-x

Data Sheet

Product Description

MHW Series dipole antennas feature a durable, unobtrusive housing that sticks permanently with integral adhesive to flat, non-conductive surfaces such as windows, drywall, ceiling tiles, plastic, etc. The antennas are well suited to low-power devices, but are capable of operation at levels to 10 watts. The MHW is supplied with either 79" [2m] or 180" [4.6m] of RG-174 cable and attaches via a standard SMA or Part 15 compliant RP-SMA connector. Custom cable lengths and connectors are available for volume OEM customers.

Features

- Compact & unobtrusive
- Adhesive for flat surfaces
- Excellent performance
- Omni-directional pattern
- Very low VSWR
- Two flexible radiating elements
- Rugged & damage-resistant
- Standard SMA or Part 15 compliant RP-SMA connector

Electrical Specifications

Center frequency:	418MHz
Recommended Oper. Freq:	408–428MHz
Wavelength:	1/2-wave
VSWR:	≤ 1.9 typical at center
Peak Gain:	2.1 dBi
Impedance:	50-ohms
Connection:	SMA or RP-SMA
Cable:	79" or 180" RG-174 coax

Ordering Information

- ANT-418-MHW-RPS-L (RP-SMA connector, 180" [4.6m] coax)
- ANT-418-MHW-RPS-S (RP-SMA connector, 79" [2m] coax)
- ANT-418-MHW-SMA-L (SMA connector, 180" [4.6m] coax)
- ANT-418-MHW-SMA-S (SMA connector, 79" [2m] coax)

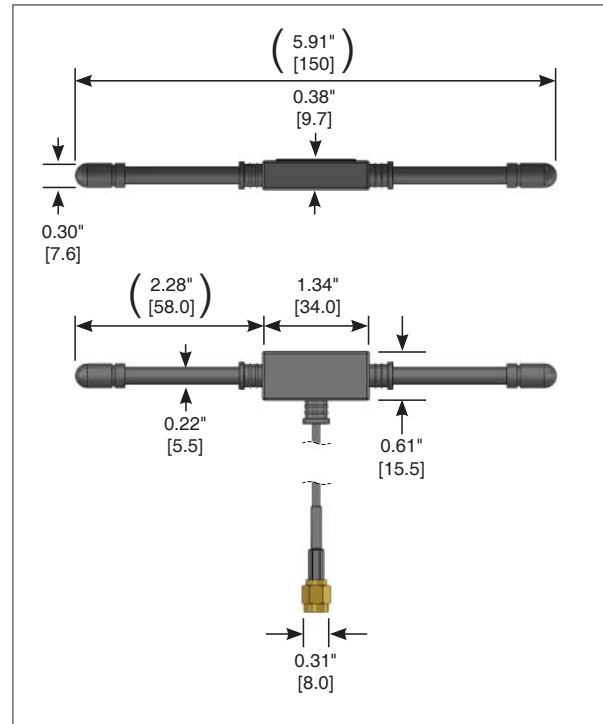

VSWR Graph

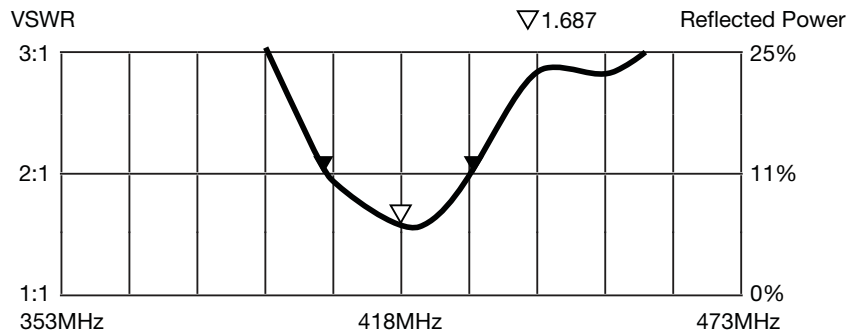

What is VSWR?

The Voltage Standing Wave Ratio (VSWR) is a measurement of how well an antenna is matched to a source impedance, typically 50-ohms. It is calculated by measuring the voltage wave that is headed toward the load versus the voltage wave that is reflected back from the load. A perfect match will have a VSWR of 1:1. The higher the first number, the worse the match, and the more inefficient the system. Since a perfect match cannot ever be obtained, some benchmark for performance needs to be set. In the case of antenna VSWR, this is usually 2:1. At this point, 88.9% of the energy sent to the antenna by the transmitter is radiated into free space and 11.1% is either reflected back into the source or lost as heat on the structure of the antenna. In the other direction, 88.9% of the energy recovered by the antenna is transferred into the receiver. As a side note, since the “:1” is always implied, many data sheets will remove it and just display the first number.

How to Read a VSWR Graph

VSWR is usually displayed graphically versus frequency. The lowest point on the graph is the antenna’s operational center frequency. In most cases, this will be different than the designed center frequency due to fabrication tolerances. The VSWR at that point denotes how close to 50-ohms the antenna gets. Linx specifies the recommended bandwidth as the range where the typical antenna VSWR is less than 2:1.

Gain Plots

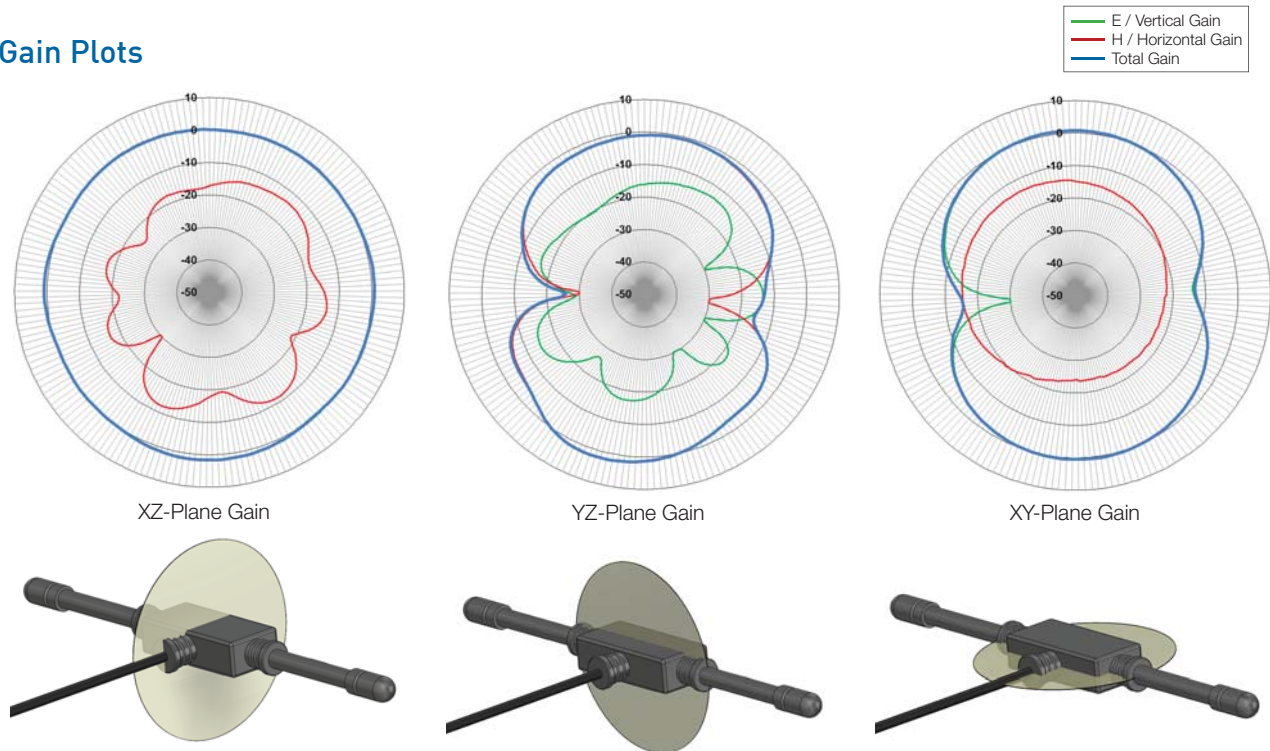

About Gain Plots

The true measure of the effectiveness of an antenna in any given application is determined by the gain and radiation pattern measurement. For antennas gain is typically measured relative to a perfect (isotropic) radiator having the same source power as the antenna under test, the units of gain in this case will be decibels isotropic (dBi). The radiation pattern is a graphical representation of signal strength measured at fixed distance from the antenna.

Gain when applied to antennas is a measure of how the antenna radiates and focuses the energy received into free space. Much like a flashlight focuses light from a bulb into a specific direction, antennas can focus RF energy into specific directions. Gain in this sense refers to an increase in energy in one direction over others.

It should also be understood that gain is not “free”, gain above 0dBi in one direction means that there must be less gain in another direction. Pictorially this can be pictured as shown in the figures to the right. The orange pattern represents the radiation pattern for a perfect dipole antenna, which is shaped like a donut. The pattern for an omnidirectional antenna with gain is shown in blue. The gain antenna is able to work with a device located further from the center along the axis of the pattern, but not with devices closer to the center when they are off the axis – the donut has been squished.

Gain is also related to the overall physical size of the antenna, as well as surrounding materials. As the geometry of the antenna is reduced below the effective wavelength (considered an electrically small antenna) the gain will decrease. As well, the relative distance between an electrically small antenna and its associated ground will impact antenna gain.

