

# 4 mm Oval Precision Optical Performance LED Lamps

## Data Sheet

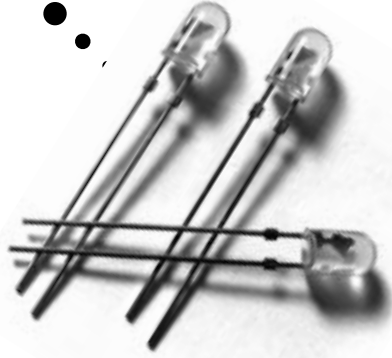
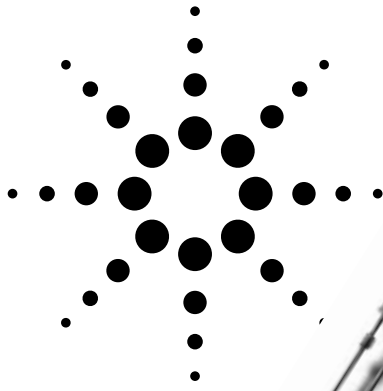

### SunPower Series

**Agilent HLMP-RG10, HLMP-SG10, HLMP-RL10, HLMP-SL10, HLMP-RD11, HLMP-SD11, HLMP-RL11, HLMP-SL11, HLMP-RM11, HLMP-SM11, HLMP-RB11, HLMP-SB11**

#### Description

These Precision Optical Performance Oval LEDs are specifically designed for Full Color/Video and Passenger Information signs. The oval shaped radiation pattern (60° x 120°) and high luminous intensity ensure that these devices are excellent for wide field of view outdoor applications where a wide viewing angle and readability in sunlight are essential. These lamps have very smooth, matched radiation patterns ensuring consistent color mixing in full color applications, message uniformity across the viewing angle of the sign.

High efficiency LED materials are used in these lamps: Aluminum Indium Gallium Phosphide

(AlInGaP) for Red and Amber color and Indium Gallium Nitride (InGaN) for Blue and Green. There are two families of red and amber lamps, AlInGaP and the higher performance AlInGaP II. Each lamp is made with an advanced optical grade epoxy offering superior high temperature and high moisture resistance in outdoor applications. The package epoxy contains both uv-a and uv-b inhibitors to reduce the effects of long term exposure to direct sunlight.

Designers can select parallel (where the axis of the leads is parallel to the wide axis of the oval radiation pattern) or perpendicular orientation. Both lamps are available in tinted version.

#### Features

- Well defined spatial radiation pattern
- Viewing angle: major axis 120° minor axis 60°
- High luminous output
- Two red and amber intensity levels AlInGaP (bright) and AlInGaP II (brightest)
- Colors 626/630 nm red 590/592 nm amber 526 nm green 470 nm blue
- Superior resistance to moisture
- UV resistant epoxy

#### Benefits

- Viewing angle designed for wide field of view applications
- Superior performance for outdoor environments
- Radiation pattern matched for red, green, and blue for full color sign

#### Applications

- Full color signs

**CAUTION:** The Blue and Green LEDs are Class 1 ESD sensitive. Please observe appropriate precautions during handling and processing. Refer to Agilent Technologies Application Note AN-1142 for additional details.



Agilent Technologies

## Package Dimensions

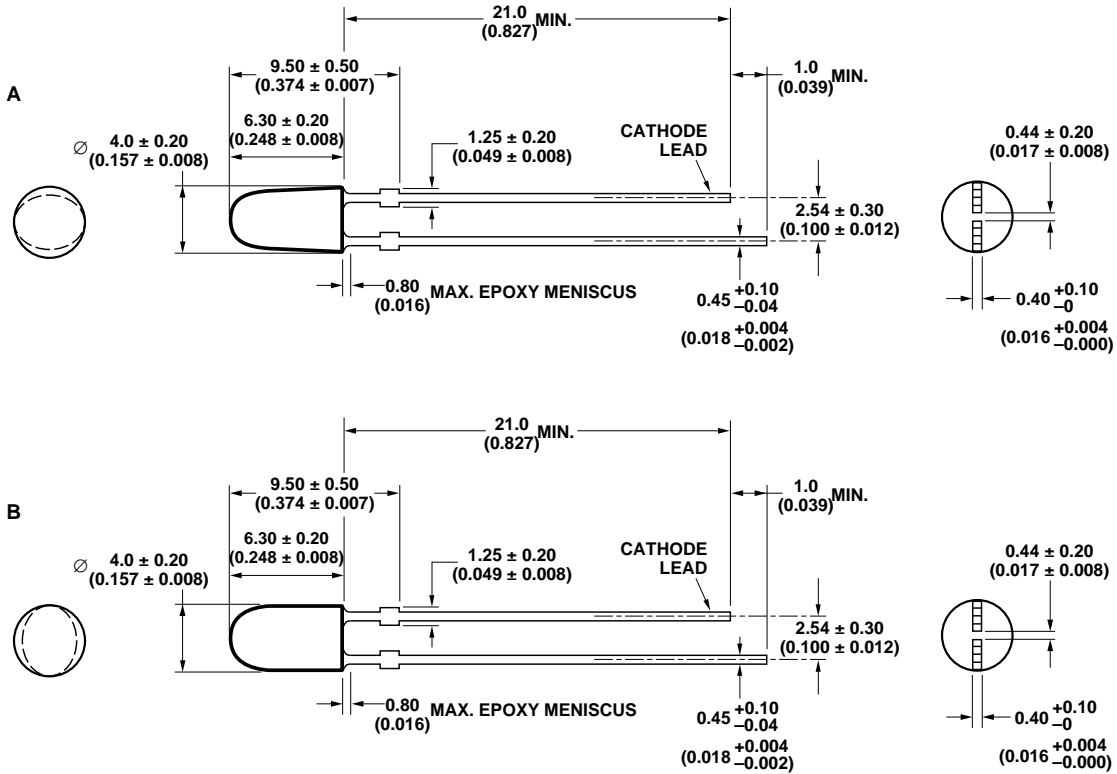

DIMENSIONS ARE IN MILLIMETERS (INCHES).

## Device Selection Guide for AlInGaP

Part Number	Color and Dominant Wavelength $\lambda_d$ (nm) Typ.	Luminous Intensity $I_v$ (mcd) at 20 mA		Leads with Stand-Offs	Leadframe Orientation	Package Drawing
		Min.	Max.			
HLMP-SG10-GK000	Red 626	120	460	Yes	Perpendicular	A
HLMP-RG10-GK000	Red 626	120	460	Yes	Parallel	B
HLMP-SG10-JM000	Red 626	205	780	Yes	Perpendicular	A
HLMP-RG10-JM000	Red 626	205	780	Yes	Parallel	B
HLMP-SL10-FJ000	Amber 590	96	360	Yes	Perpendicular	A
HLMP-RL10-FJ000	Amber 590	96	360	Yes	Parallel	B
HLMP-SL10-HL000	Amber 590	155	600	Yes	Perpendicular	A
HLMP-RL10-HL000	Amber 590	155	600	Yes	Parallel	B
HLMP-SL10-LP000	Amber 590	345	1330	Yes	Perpendicular	A
HLMP-RL10-LP000	Amber 590	345	1330	Yes	Parallel	B

### Notes:

1. The luminous intensity is measured on the mechanical axis of the lamp package.
2. The optical axis is closely aligned with the package mechanical axis.
3. The dominant wavelength,  $\lambda_d$ , is derived from the CIE Chromaticity Diagram and represents the color of the lamp.

### Device Selection Guide for AlInGaP II

Part Number	Color and Dominant Wavelength $\lambda_d$ (nm) Typ.	Luminous Intensity $I_v$ (mcd) at 20 mA		Leads with Stand-Offs	Leadframe Orientation	Package Drawing
		Min.	Max.			
HLMP-SD11-LP000	Red 630	345	1330	Yes	Perpendicular	A
HLMP-RD11-LP000	Red 630	345	1330	Yes	Parallel	B
HLMP-SD11-LPT00	Red 630	345	1330	Yes	Perpendicular	A
HLMP-RD11-LPT00	Red 630	345	1330	Yes	Parallel	B
HLMP-SD11-MNT00	Red 630	450	1010	Yes	Perpendicular	A
HLMP-SL11-HLR00	Amber 592	155	600	Yes	Perpendicular	A
HLMP-SL11-LP000	Amber 592	345	1330	Yes	Perpendicular	A
HLMP-RL11-LP000	Amber 592	345	1330	Yes	Parallel	B
HLMP-SL11-LPR00	Amber 592	345	1330	Yes	Perpendicular	A
HLMP-RL11-LPR00	Amber 592	345	1330	Yes	Parallel	B
HLMP-SL11-LPV00	Amber 592	345	1330	Yes	Perpendicular	A
HLMP-RL11-LPV00	Amber 592	345	1330	Yes	Parallel	B

**Notes:**

1. The luminous intensity is measured on the mechanical axis of the lamp package.
2. The optical axis is closely aligned with the package mechanical axis.
3. The dominant wavelength,  $\lambda_d$ , is derived from the CIE Chromaticity Diagram and represents the color of the lamp.

### Device Selection Guide for InGaN

Part Number	Color and Dominant Wavelength $\lambda_d$ (nm) Typ.	Luminous Intensity $I_v$ (mcd) at 20 mA		Leads with Stand-Offs	Leadframe Orientation	Package Drawing
		Min.	Max.			
HLMP-SM11-LP000	Green 526	345	1330	Yes	Perpendicular	A
HLMP-RM11-LP000	Green 526	345	1330	Yes	Parallel	B
HLMP-SB11-EH000	Blue 470	70	270	Yes	Perpendicular	A
HLMP-RB11-EH000	Blue 470	70	270	Yes	Parallel	B

**Notes:**

4. The luminous intensity is measured on the mechanical axis of the lamp package.
5. The optical axis is closely aligned with the package mechanical axis.
6. The dominant wavelength,  $\lambda_d$ , is derived from the CIE Chromaticity Diagram and represents the color of the lamp.

## Part Numbering System

HLMP - x x xx - x x x xx

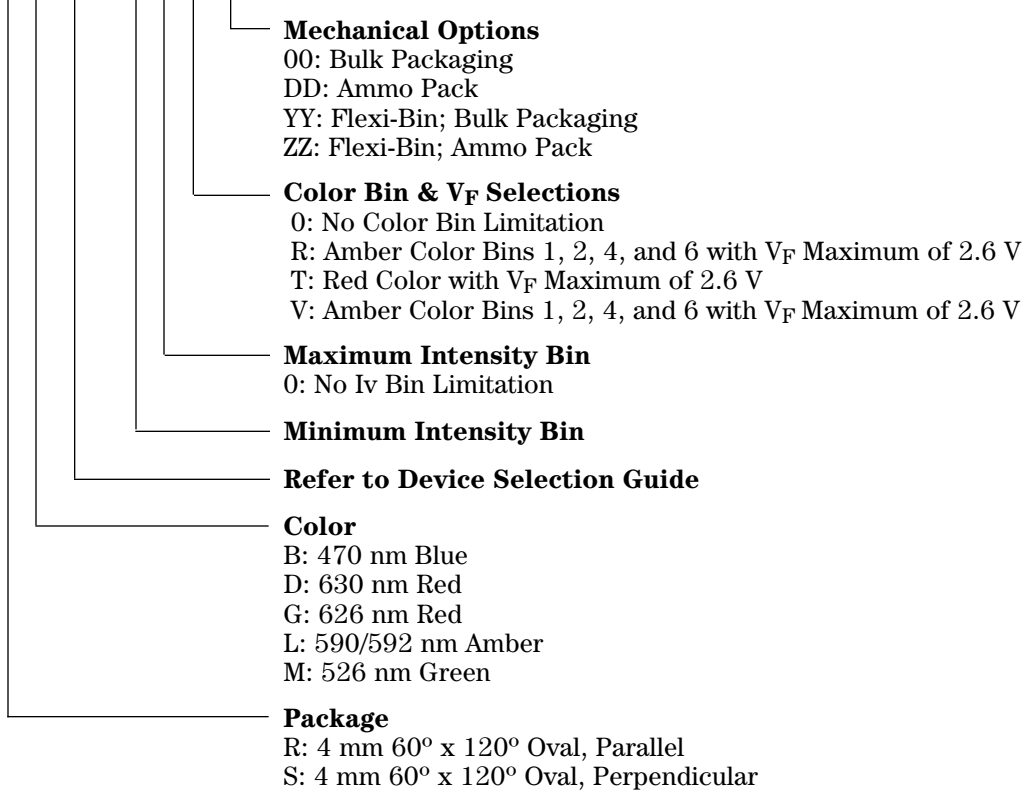

## Absolute Maximum Ratings

T<sub>A</sub> = 25°C

Parameter	Blue and Green	Amber and Red
DC Forward Current <sup>[1]</sup>	30 mA	50 mA
Peak Pulsed Forward Current	100 mA	100 mA
Average Forward Current	30 mA	30 mA
Reverse Voltage (I <sub>R</sub> = 100 μA)	5 V	5 V
Power Dissipation	120 mW	120 mW
LED Junction Temperature	130°C	130°C
Operating Temperature Range	-40°C to +80°C	-40°C to +100°C
Storage Temperature Range	-40°C to +100°C	-40°C to +120°C
Soldering Temperature	260° for 5 sec	260° for 5 sec

### Note:

1. Derate linearly as shown in Figures 6 and 7.

## Electrical/Optical Characteristics

$T_A = 25^\circ\text{C}$

Parameter	Symbol	Min.	Typ.	Max.	Units	Test Conditions
Typical Viewing Angle <sup>[1]</sup>	$2\theta_{1/2}$				deg	
Major			120			
Minor			60			
Forward Voltage	$V_F$				V	$I_F = 20\text{ mA}$
Red ( $\lambda_d = 626\text{ nm}$ )			1.9	2.4		
Red ( $\lambda_d = 630\text{ nm}$ )			2.0	2.4 <sup>[2]</sup>		
Amber ( $\lambda_d = 590\text{ nm}$ )			2.02	2.4		
Amber ( $\lambda_d = 592\text{ nm}$ )			2.15	2.4 <sup>[2]</sup>		
Blue ( $\lambda_d = 470\text{ nm}$ )			3.5	4.0		
Green ( $\lambda_d = 526\text{ nm}$ )			3.5	4.0		
Reverse Voltage	$V_R$				V	$I_R = 100\ \mu\text{A}$
Amber and Red		5	20			
Blue and Green		5	–			
Peak Wavelength	$\lambda_{\text{PEAK}}$				nm	Peak of Wavelength of Spectral Distribution at $I_F = 20\text{ mA}$
Red ( $\lambda_d = 626\text{ nm}$ )			635			
Red ( $\lambda_d = 630\text{ nm}$ )			639			
Amber ( $\lambda_d = 590\text{ nm}$ )			592			
Amber ( $\lambda_d = 592\text{ nm}$ )			594			

## LED Indicators

Parameter	Symbol	Min.	Typ.	Max.	Units	Test Conditions
Blue ( $\lambda_d = 470\text{ nm}$ )			467			
Green ( $\lambda_d = 526\text{ nm}$ )			524			
Spectral Halfwidth	$\Delta\lambda_{1/2}$				nm	Wavelength Width at Spectral Distribution $1/2$ Power Point at $I_F = 20\text{ mA}$
Red ( $\lambda_d = 626/630\text{ nm}$ )			17			
Amber ( $\lambda_d = 590/592\text{ nm}$ )			17			
Blue ( $\lambda_d = 470\text{ nm}$ )			20			
Green ( $\lambda_d = 526\text{ nm}$ )			35			
Capacitance	C				pF	$V_F = 0, F = 1\text{ MHz}$
All Colors			40			
Thermal Resistance	$R\theta_{\text{J-PIN}}$				$^\circ\text{C/W}$	LED Junction-to-Cathode Lead
All Colors			240			
Luminous Efficacy <sup>[3]</sup>	$\eta_v$				lm/W	Emitted Luminous Power/Emitted Radiant Power
Red ( $\lambda_d = 626\text{ nm}$ )			150			
Red ( $\lambda_d = 630\text{ nm}$ )			155			
Amber ( $\lambda_d = 590\text{ nm}$ )			480			
Amber ( $\lambda_d = 592\text{ nm}$ )			500			
Blue ( $\lambda_d = 470\text{ nm}$ )			70			
Green ( $\lambda_d = 526\text{ nm}$ )			540			

### Notes:

1.  $2\theta_{1/2}$  is the off-axis angle where the luminous intensity is the on-axis intensity.
2. For options -xxRxx, -xxTxx, and -xxVxx, maximum forward voltage,  $V_F$ , is 2.6 V.
3. The radiant intensity,  $I_e$ , in watts per steradian, may be found from the equation  $I_e = I_v/\eta_v$ , where  $I_v$  is the luminous intensity in candelas and  $\eta_v$  is the luminous efficacy in lumens/watt.

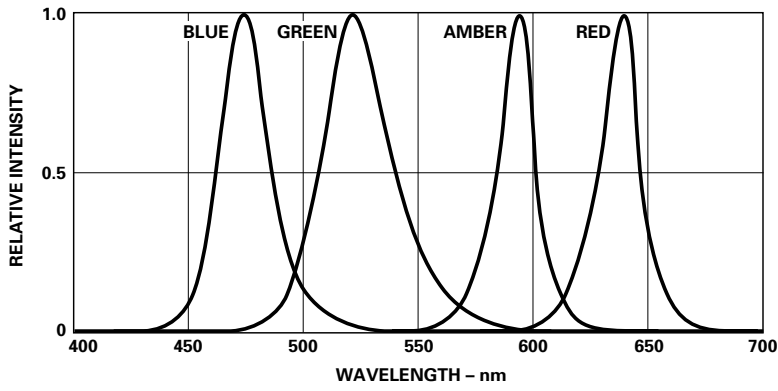

Figure 1. Relative intensity vs. wavelength.

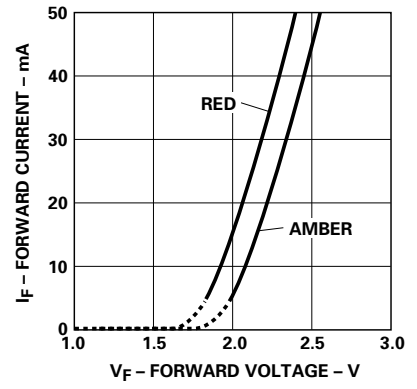

Figure 2. Amber, Red forward current vs. forward voltage.

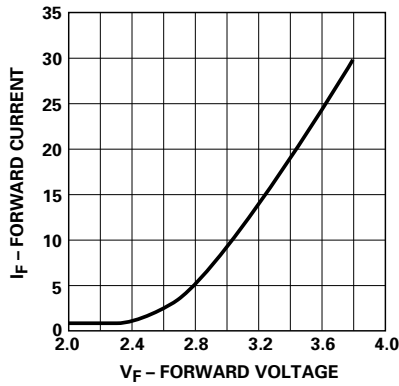

Figure 3. Blue, Green forward current vs. forward voltage.

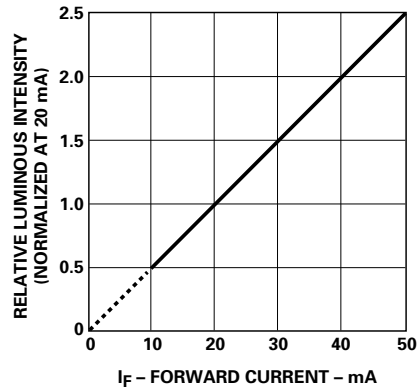

Figure 4. Amber, Red relative luminous intensity vs. forward current.

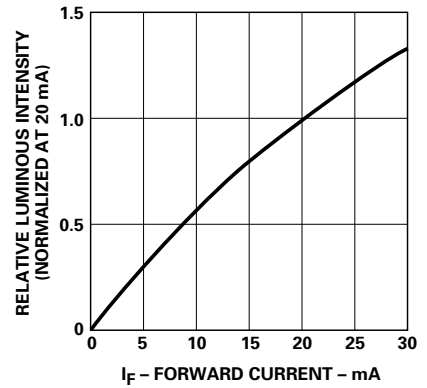

Figure 5. Blue, Green relative luminous intensity vs. forward current.

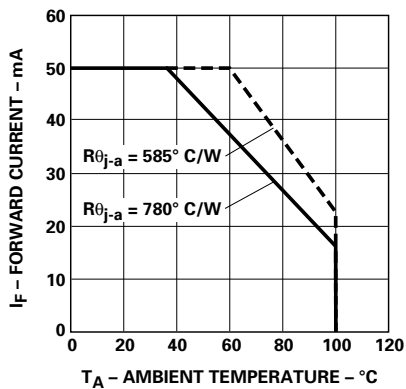

Figure 6. Amber, Red maximum forward current vs. ambient temperature.

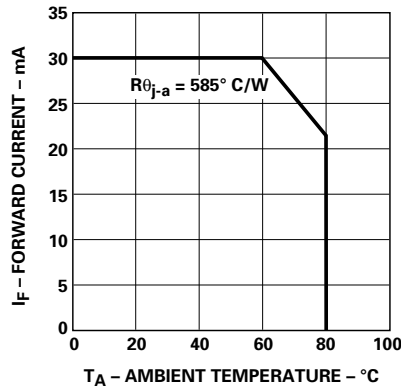

Figure 7. Blue, Green maximum forward current vs. ambient temperature.

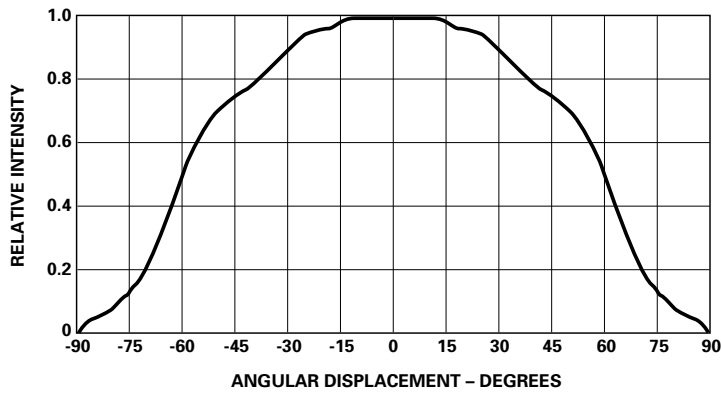

Figure 8a. Representative spatial radiation pattern for major axis.

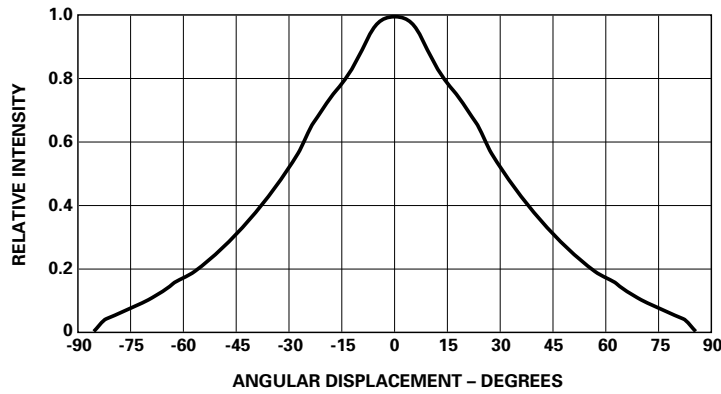

Figure 8b. Representative spatial radiation pattern for minor axis.

**Intensity Bin Limits**  
(mcd at 20 mA)

Bin Name	Min.	Max.
E	85	110
F	110	140
G	140	180
H	180	240
J	240	310
K	310	400
L	400	520
M	520	680
N	680	880
P	880	1150

Tolerance for each bin limit is  $\pm 15\%$ .

**Note:**

1. Bin categories are established for classification of products. Products may not be available in all bin categories.

## Color Bin Limits (nm at 20 mA)

Blue Bin	Color Range (nm)	
	Min.	Max.
1	460.0	464.0
2	464.0	468.0
3	468.0	472.0
4	472.0	476.0
5	476.0	480.0

Tolerance for each bin limit is  $\pm 2$  nm.

Green Bin ID	Color Range (nm)	
	Min.	Max.
1	520.0	524.0
2	524.0	528.0
3	528.0	532.0
4	532.0	536.0
5	536.0	540.0

Tolerance for each bin limit is  $\pm 0.5$  nm.

Amber Bin ID	Color Range (nm)	
	Min.	Max.
1	584.5	587.0
2	587.0	589.5
4	589.5	592.0
6	592.0	594.5

Tolerance for each bin limit is  $\pm 0.5$  nm.

### Note:

- All bin categories are established for classification of products. Products may not be available in all bin categories. Please contact your Agilent representatives for further information.

## [www.agilent.com/semiconductors](http://www.agilent.com/semiconductors)

For product information and a complete list of distributors, please go to our web site.

For technical assistance call:

Americas/Canada: +1 (800) 235-0312 or  
(408) 654-8675

Europe: +49 (0) 6441 92460

China: 10800 650 0017

Hong Kong: (+65) 6271 2451

India, Australia, New Zealand: (+65) 6271 2394

Japan: (+81 3) 3335-8152(Domestic/International), or 0120-61-1280(Domestic Only)

Korea: (+65) 6271 2194

Malaysia, Singapore: (+65) 6271 2054

Taiwan: (+65) 6271 2654

Data subject to change.

Copyright © 2002 Agilent Technologies, Inc.

Obsoletes 5988-7318EN

October 29, 2002

5988-8250EN



**Agilent Technologies**