

RJ45 Dual USB Jack with 10/100 Magnetic

ARJU31A

RoHS
Compliant



17.40 x 30.40 x 26.10mm

FEATURES:

- Tab up RJ 45 Jack + 2 USB
- Available with or without LED
- Suitable CAT 5 & 6 cable and UTP
- Comply IEEE 802.3ab
- LAN Magnetic with RJ45 Jack
- Suitable for RoHS compliant reflow

APPLICATIONS:

- 10 and 100 Base-TX
- NIC, LoM and PC

STANDARD SPECIFICATIONS

Operating temperature range: 0°C to +70°C Storage temperature range: -40°C to +85°C

Part Number	Turns Ratio		EMI Fingers	LEDs	Insertion Loss (dB max)	Return Loss (dB TYP @100Ω±15Ω)		
	TX	RX				1 - 10 MHz	30 MHz	60 - 80 MHz
ARJU31A-MASA-AD-B-E-LU2	1CT:1	1CT:1CT	Yes	GO/Y	-1.0	-20	-16	-12

Part Number	Crosstalk (dB MIN)			Common Mode Rejection (dB TYP)		Hipot (Vrms) @ 60Hz
	1-10 MHz	32-60 MHz	60-100 MHz	1 - 50 MHz	50 - 130 MHz	
ARJU31A-MASA-AD-B-E-LU2	-40	-35	-30	-30	-20	1500

Contact Abracon for more custom configurations. See options to build a custom configuration.

OPTIONS AND PART IDENTIFICATION

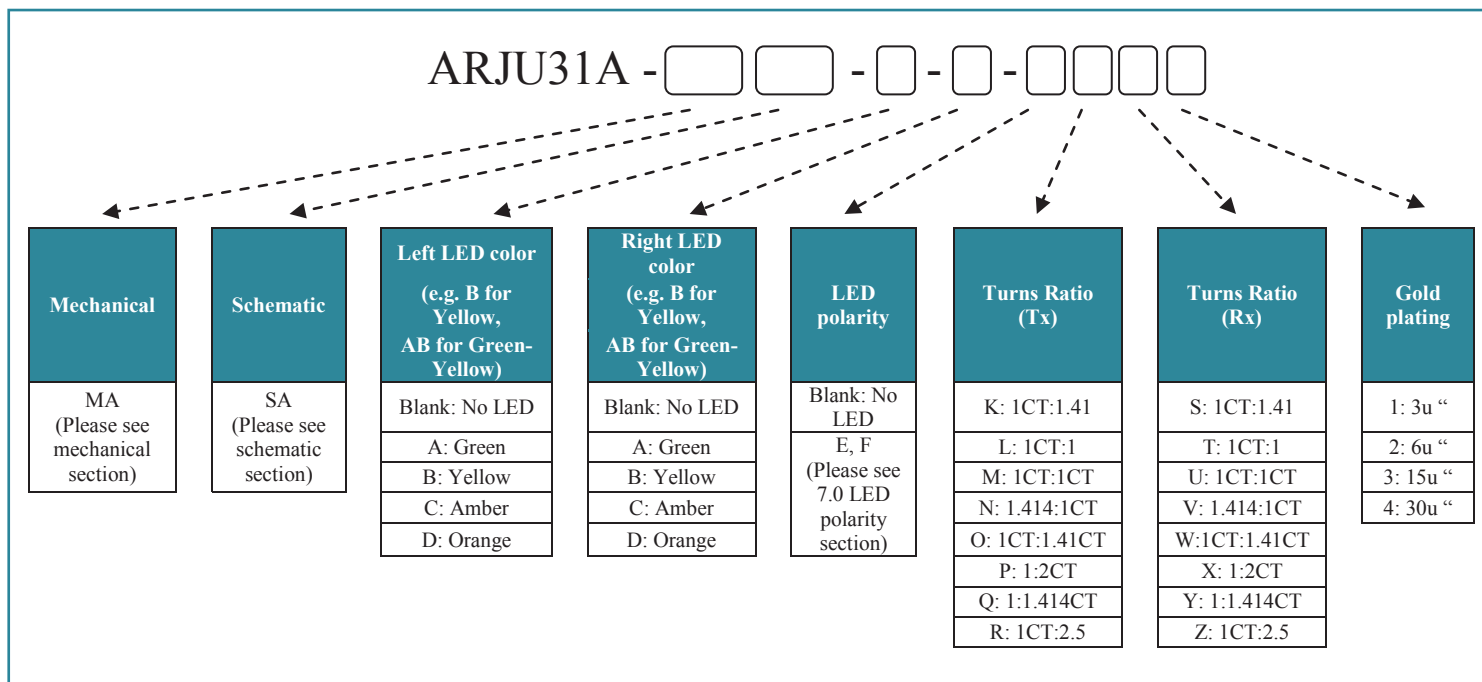



17.40 x 30.40 x 26.10mm

MECHANICAL DIMENSIONS

MA

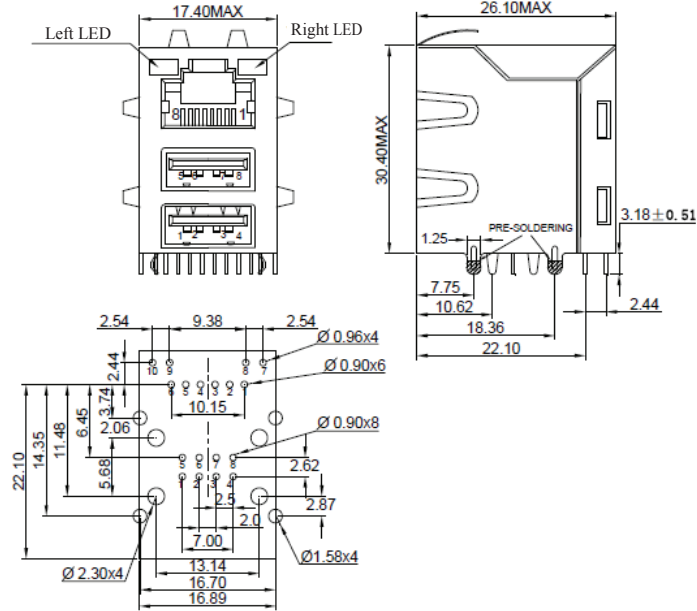

PC Board Layout
Component Side Shown

Dimension: mm. All tolerances are ± 0.25 unless otherwise specified

SCHEMATICS

SA

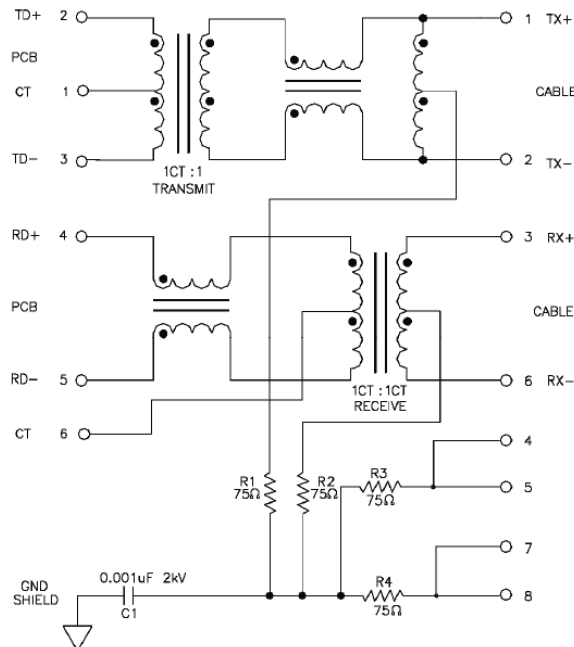

RJ45 Dual USB Jack with 10/100 Magnetic

ARJU31A

RoHS
Compliant



17.40 x 30.40 x 26.10mm

LED POLARITY

E

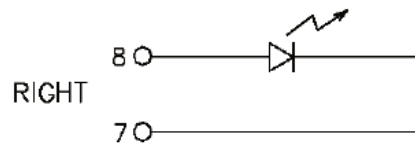
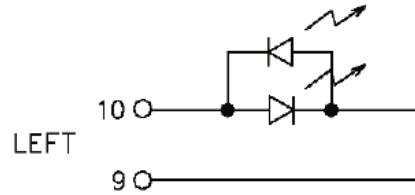

F

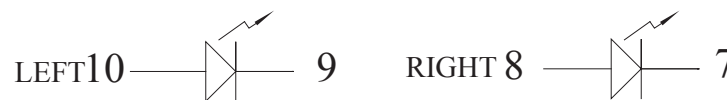

PACKING: 40pcs/tray

Packaging material: PET

Outer carton unit 640 pcs/ 16 Trays/box

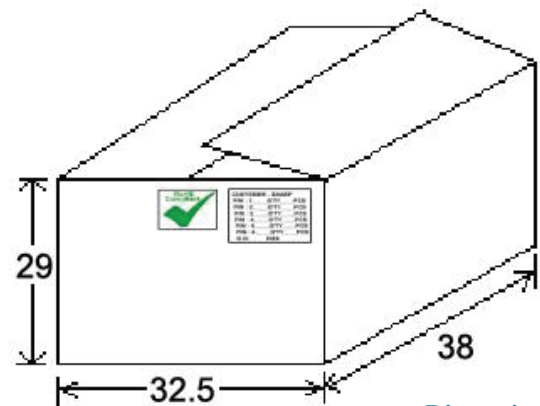
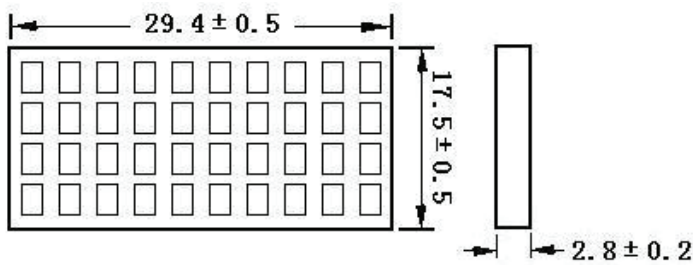

Dimensions: cm

ABRACON IS
ISO 9001:2008
CERTIFIED



Visit www.abracon.com for Terms & Conditions of Sale
30332 Esperanza, Rancho Santa Margarita, California 92688
tel 949-546-8000 | fax 949-546-8001 | www.abracon.com

Revised: 08.26.11

RJ45 Dual USB Jack with 10/100 Magnetic

ARJU31A

RoHS
Compliant



17.40 x 30.40 x 26.10mm

REFLOW PROFILE:

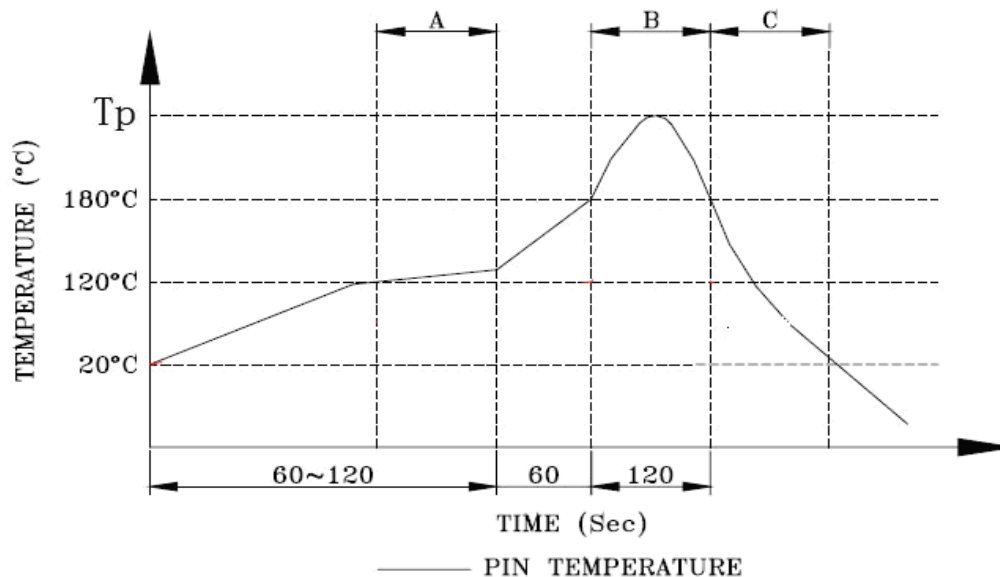

Peak temperature(Tp) : 250± 10°C

Peak temperature(Tp) time : 5sec max

ATTENTION: Abracon Corporation's products are COTS – Commercial-Off-The-Shelf products; suitable for Commercial, Industrial and, where designated, Automotive Applications. Abracon's products are not specifically designed for Military, Aviation, Aerospace, Life-dependant Medical applications or any application requiring high reliability where component failure could result in loss of life and/or property. For applications requiring high reliability and/or presenting an extreme operating environment, written consent and authorization from Abracon Corporation is required. Please contact Abracon Corporation for more information.

ABRACON IS
ISO 9001:2008
CERTIFIED

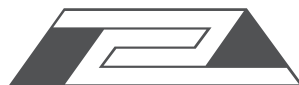

ABRACON
CORPORATION

Visit www.abracon.com for Terms & Conditions of Sale
30332 Esperanza, Rancho Santa Margarita, California 92688
tel 949-546-8000 | fax 949-546-8001 | www.abracon.com

Revised: 08.26.11