

MITSUBISHI IGBT MODULES
CM100DY-34A

HIGH POWER SWITCHING USE

CM100DY-34A



- IC 100A
- VCES 1700V
- Insulated Type
- 2-elements in a pack

APPLICATION

General purpose inverters & Servo controls, etc

OUTLINE DRAWING & CIRCUIT DIAGRAM

Dimensions in mm

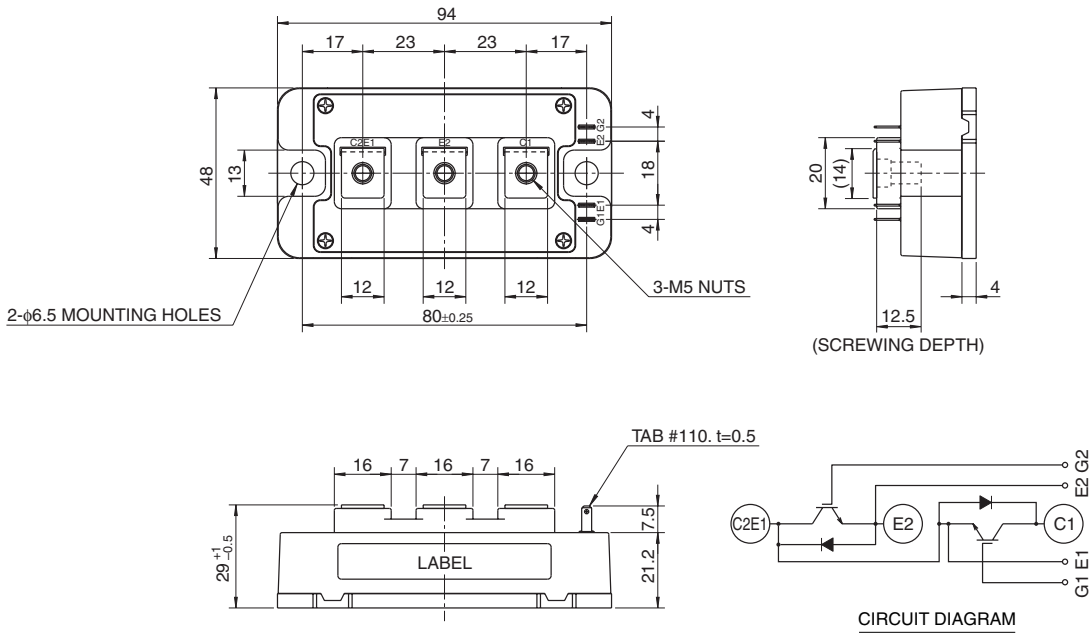

CM100DY-34A

HIGH POWER SWITCHING USE

ABSOLUTE MAXIMUM RATINGS (T_J = 25°C, unless otherwise specified)

Symbol	Parameter	Conditions	Ratings	Unit
V _{CE} S	Collector-emitter voltage	G-E Short	1700	V
V _{GE} S	Gate-emitter voltage	C-E Short	±20	V
I _C	Collector current	DC, T _C = 108°C ^{*1}	100	A
I _{CM}		Pulse	200	
I _E (Note 1)	Emitter current	Operation	100	A
I _{EM} (Note 1)		Pulse	200	
P _C (Note 3)	Maximum collector dissipation	T _C = 25°C ^{*1}	960	W
T _J	Junction temperature		-40 ~ +150	°C
T _{stg}	Storage temperature		-40 ~ +125	°C
V _{iso}	Isolation voltage	Main terminal to base plate, AC 1 min.	3500	V
—	Torque strength	Main terminal M5	2.5 ~ 3.5	N • m
—		Mounting holes M6	3.5 ~ 4.5	
—	Weight	Typical value	310	g

ELECTRICAL CHARACTERISTICS (T_J = 25°C, unless otherwise specified)

Symbol	Parameter	Test conditions	Limits			Unit
			Min.	Typ.	Max.	
I _{CE} S	Collector cutoff current	V _{CE} = V _{CE} S, V _{GE} = 0V	—	—	1	mA
V _{GE(th)}	Gate-emitter threshold voltage	I _C = 10mA, V _{CE} = 10V	5.5	7.0	8.5	V
I _{GE} S	Gate leakage current	±V _{GE} = V _{GE} S, V _{CE} = 0V	—	—	2.0	μA
V _{CE(sat)}	Collector to emitter saturation voltage	T _J = 25°C	—	2.2	2.8	V
		T _J = 125°C	I _C = 100A, V _{GE} = 15V	—	2.45	
C _{ies}	Input capacitance	V _{CE} = 10V V _{GE} = 0V	—	—	24.7	nF
C _{oes}	Output capacitance		—	—	2.8	
C _{res}	Reverse transfer capacitance		—	—	0.53	
Q _G	Total gate charge	V _{CC} = 1000V, I _C = 100A, V _{GE} = 15V	—	670	—	nC
t _{d(on)}	Turn-on delay time	V _{CC} = 1000V, I _C = 100A V _{GE1} = V _{GE2} = 15V R _G = 4.8Ω, Inductive load switching operation I _E = 100A	—	—	200	ns
t _r	Turn-on rise time		—	—	150	
t _{d(off)}	Turn-off delay time		—	—	550	
t _f	Turn-off fall time		—	—	350	
t _{rr} (Note 1)	Reverse recovery time		—	—	300	
Q _{rr} (Note 1)	Reverse recovery charge		—	10	—	μC
V _{EC} (Note 1)	Emitter-collector voltage	I _E = 100A, V _{GE} = 0V	—	—	3.0	V
R _{th(j-c)Q}	Thermal resistance	IGBT part (1/2 module) ^{*1}	—	—	0.13	°C/W
R _{th(j-c)R}		FWDi part (1/2 module) ^{*1}	—	—	0.21	
R _{th(c-f)}	Contact thermal resistance	Case to fin, Thermal compound applied (1/2 module) ^{*1,*2}	—	0.022	—	
R _G	External gate resistance		4.8	—	48	Ω

*1 : T_C, T_f measured point is just under the chips.

*2 : Typical value is measured by using Shin-Etsu Chemical Co.,Ltd "G-746".

Note 1. I_E, I_{EM}, V_{EC}, t_{rr} & Q_{rr} represent characteristics of the anti-parallel, emitter to collector free-wheel diode (FWDi).

2. Pulse width and repetition rate should be such that the device junction temperature (T_J) does not exceed T_{Jmax} rating.

3. Junction temperature (T_J) should not increase beyond 150°C.

4. Pulse width and repetition rate should be such as to cause negligible temperature rise.

PERFORMANCE CURVES

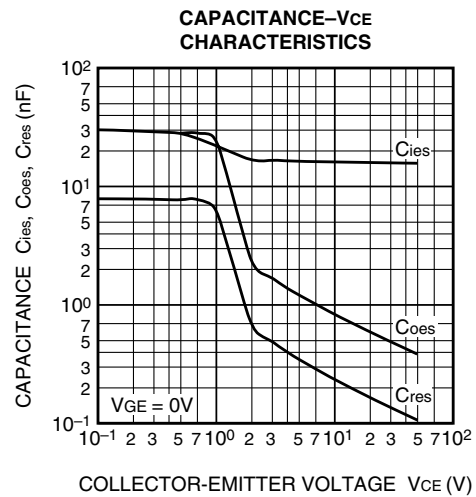
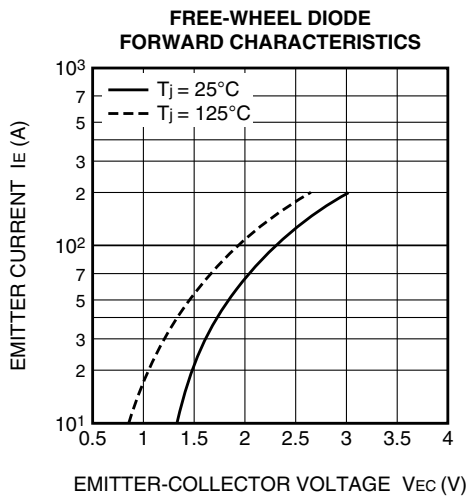
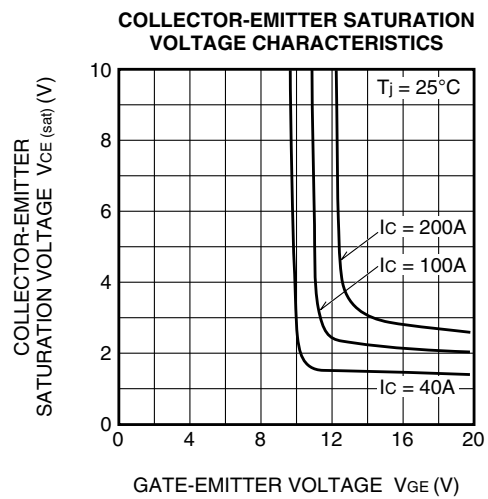
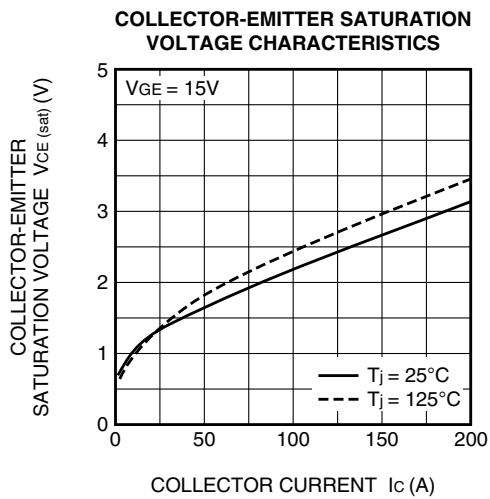
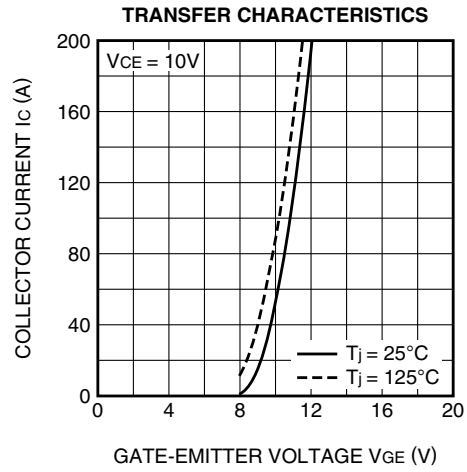
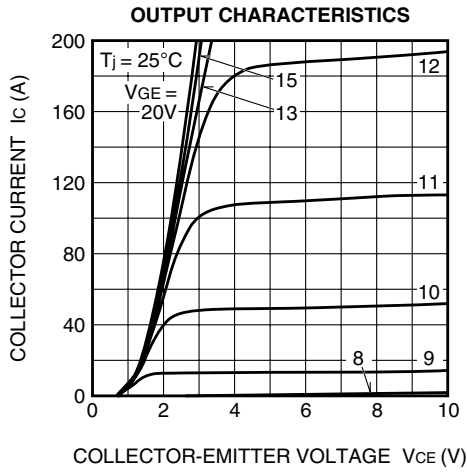

CM100DY-34A

HIGH POWER SWITCHING USE

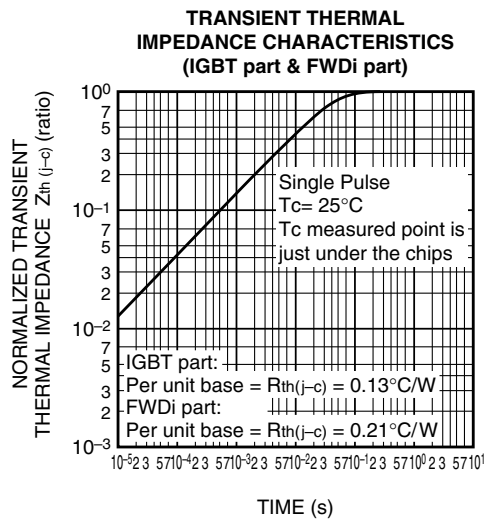
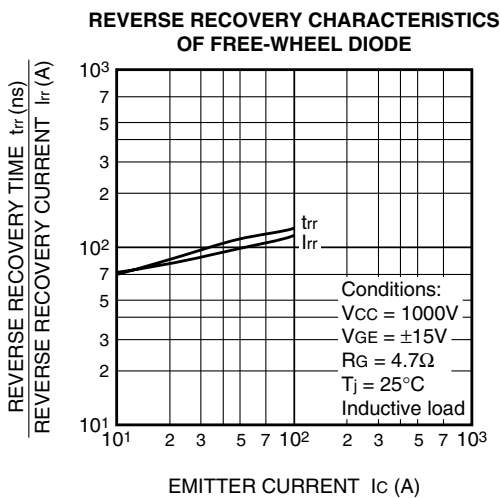
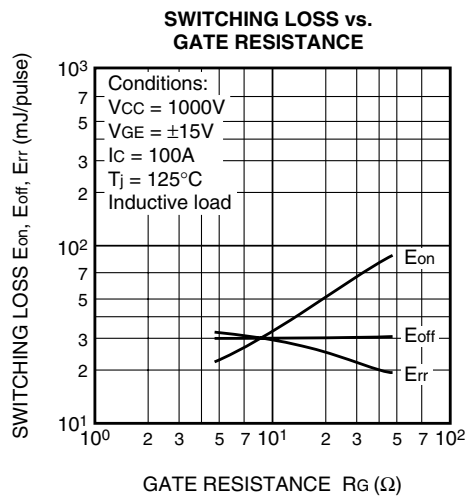
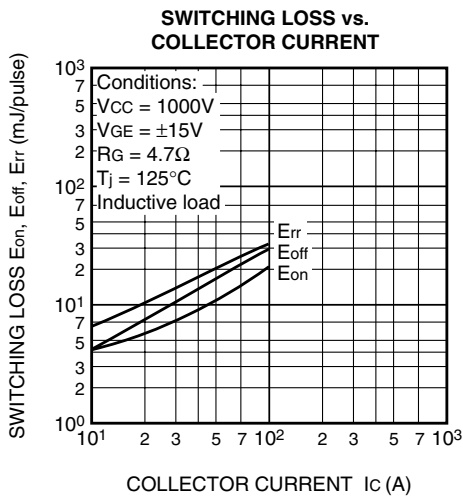
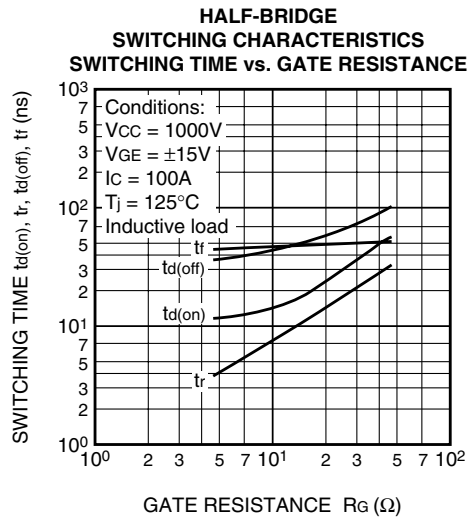
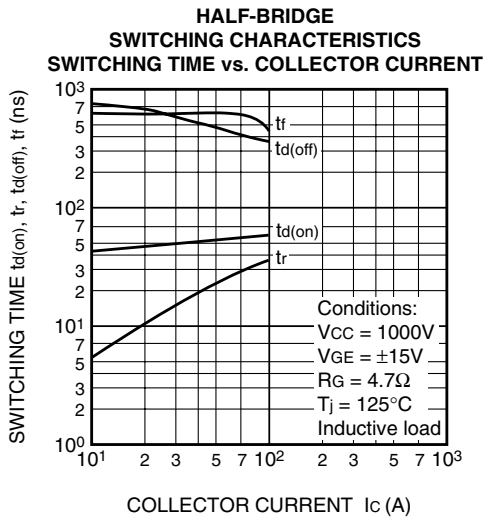

CM100DY-34A

HIGH POWER SWITCHING USE

