



PRODUCT SPECIFICATION

Part Number

PT804890B-TLMWD-ER09

CUSTOMER	
CUSTOMER PART NUMBER	
DESCRIPTION	9.0" TFT LCD, RTP
APPROVED BY	
DATE	



P-TEC

MODEL NO.

PAGE

PT804890B-TLMWD-ER09

SPEC SAMPLE

2

1. Table of Contents

No.	Contents	Page
1	Table of Contents	2
2	Record of Revisions	3
3	Module Numbering System	4
4	Application	5
5	Features	5
6	General Specifications	5
7	Absolute Maximum Ratings	6
8	Electrical Characteristics	7
9	Block Diagram	11
10	Input / Output Terminals Pin Assignment	12
11	Interface Timing	16
12	Optical Characteristics	20
13	Reliability Test	23
14	Packaging	24
15	Precautions	25
16	Outline Drawing	27
17	Definition of Labels	28
18	Incoming Inspection Standards	30



P-TEC

MODEL NO.

PAGE

PT804890B-TLMWD-ER09

SPEC SAMPLE

4

3. Module Numbering System

P T _____ - _____ - _____
1. 2. 3. 4. 5. 6. 7. 8. 9 10. 11. 12. 13. 14.

1. P-TEC TFT

8. VIEWING DIRECTION

D: 6 o'clock
U: 12 o'clock
F: Full Viewing Angle

2. LENGTH x WIDTH PIXELS

If third character is a zero, it is removed to shorten part number. Example: 240 x 320 = PT3224

9. A ~ Z CODE

Assigned by P-tec

3. DIAGONAL DIMENSIONS

Example: 3.5" display = 35 in part number

11. TEMPERATURE RANGE

Normal: Left Blank
Wide: X

4. PRODUCT VERSION

Series assigned by P-tec

12. LUMINANCE

Blank: Normal (<300 nit)
M: Middle (>= 300 nit)
H: High (> 600 nit)

5. LCD MODE

T: TN
I: IPS
V: VA

13. TOUCH PANEL OPTION

No TP: Left Blank
C: Capacitive TP
R: Resistive TP

6. POLARIZER

LM: Transmissive
LF: Transflective

14. SPECIAL CHARACTERS

Customer special requirements

7. BACKLIGHT COLOR

No Backlight: Left Blank
W: White
B: Blue/Green
S: Yellow/Green



4. Application

This specification is applied to the 9 inch WVGA supported TFT-LCD module, and can display true 262,144 colors(8 bit/ color). The module is designed for OA, Car TV application and other electronic products which require flat panel display of digital signal interface. This module is composed of a 9”TFT-LCD panel, a driver circuit and LED backlight unit and used as the input devices for general electric appliances via both finger and pen-entry.

5. Features

- WVGA (800×480 pixels) resolution.
- Digital 24 bit parallel RGB.
- Dot inversion mode with stripe type.
- Transparent Touch panel
 - 4-Wire
 - Analog Resistive

6. General Specifications

Item	Specifications	Unit
Screen Size	9 (Diagonal)	inch
Display Format	800RGB(H)×480(V)	dot
Active Area	198.0(H)×111.696(V)	mm
Dot Pitch	0.0825(H)×0.2327(V)	mm
Pixel Configuration	RGB Vertical Stripe	-
Display Mode	TN Type Transmissive Mode Normally White	-
Surface Treatment	Anti-Glare and Hard Coating(3H)	-
Viewing Direction	6 O'clock (The Gray Inversion will appear at this direction)	-
Outline Dimension	211.1(W)×126.5(H)×7.5(D)	mm
Weight	330.5	g
RoHS Compliance	P-tec certifies this product to be in compliance with European Union Directive 2002/95/EC on the restriction of certain hazardous substances in electrical and electronic equipment.	-



7. Absolute Maximum Ratings

7.1 Absolute Ratings of Environment

Item	Symbol	Value		Unit	Note
		Min.	Max.		
Storage Temperature	T _{ST}	-30	+80	°C	(1)(2)
Operating Ambient Temperature	T _{OP}	-20	+70	°C	(1)(2)

Note1: Background color changes slightly depending on ambient temperature.

This phenomenon is reversible.

Note2: Please refer to item of RELIABILITY.

7.2 Electrical Absolute Ratings

7.2.1 TFT-LCD Module

(Ta=25±2°C, GND=V_{SS}=0V)

Item	Symbol	Value		Unit	Note
		Min.	Max.		
Digital Power Supply Voltage	DV _{DD}	-0.3	5.0	V	-
Analog Power Supply Voltage	AV _{DD}	-0.5	13.5	V	-
Gate High Voltage	V _{GH}	13.0	19.0	V	-
Gate Low Voltage	V _{GL}	-12.0	-2.0	V	-
Gate High To Gate Low Voltage	V _{GH} - V _{GL}	-	31.0	V	-

7.2.2 Backlight Unit

(Ta=25±2°C)

Item	Symbol	Value		Unit	Note
		Min.	Max.		
Current of Backlight Unit	I _B	-	250	mA	(1)
Voltage of Backlight Unit	V _B	-	11.0	V	(1)

Note (1) Permanent damage to the device may occur if maximum values are exceeded or reverse voltage is loaded.

**8. Electrical Characteristics****8.1 TFT-LCD Module**

(Ta=25±2°C)

Item	Symbol	Value			Unit	Note
		Min.	Typ.	Max.		
Digital Power Supply Voltage	DV _{DD}	3.0	3.3	3.6	V	-
Analog Power Supply Voltage	AV _{DD}	10.2	10.4	10.6	V	-
Gate High Voltage	V _{GH}	16.3	17.0	17.7	V	-
Gate Low Voltage	V _{GL}	-5.7	-5.0	-4.3	V	-
Input signal voltage	V _{COM}	4.0	4.2	4.4	V	-
Digital Power Supply Current	DI _{DD}	-	5.5	10	mA	(1)
Analog Power Supply Current	AI _{DD}		32	50	mA	(1)
Gate High Current	I _{GH}		0.3	1	mA	(1)
Gate Low Current	I _{GL}		0.3	1	mA	(1)
Input High Threshold Voltage	V _{IH}	0.7 DV _{DD}	-	DV _{DD}	V	-
Input Low Threshold Voltage	V _{IL}	0	-	0.3 DV _{DD}	V	-
VSYNC Frequency	F _V	-	60	-	Hz	-
DCLK Frequency	DCLK	-	33.26	-	MHz	-

Note (1) The specified power consumption is under the conditions at DV_{DD} =3.3V, AV_{DD} =10.4V, V_{GH} =17.0V, V_{GL} =-5V, V_{COM} =4.2V ,F_V=60Hz, whereas a power dissipation check pattern below is displayed.

Black Pattern / 0 Gray

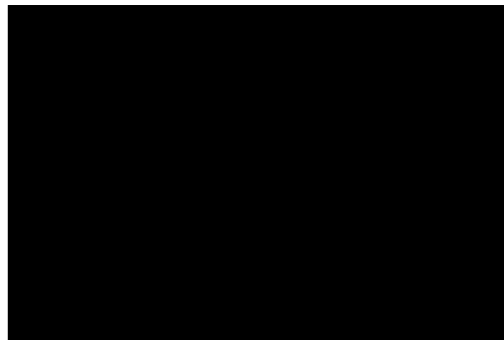

Active Area



8.2 Backlight Unit

(Ta=25±2°C)

Item	Symbol	Value			Unit	Note
		Min.	Typ.	Max.		
Current of Backlight Unit	I _B	198	220	242	mA	(1)
Voltage of Backlight Unit	V _B	9.3	9.9	10.5	V	I _B =220mA
Power Consumption	P _{BL}	-	(2.18)	-	W	I _B =220mA
LED Life Time(25°C)	-	20000	-	-	hr	(2)

Note 1: The LED Supply Voltage is defined by the number of LED at Ta=25°C and IL =220mA.

Note 2: The “LED life time” is defined as the module brightness decrease to 50% original brightness at Ta=25°C and IL =220mA. The LED lifetime could be decreased if operating IL is larger than 220 mA.



8.3 Transparent Touch panel

Electrical characteristics

Item		Value			Unit	Note
		Min.	Typ.	Max.		
Operating Voltage		-	-	7	V	-
Terminal Resistance	X-direction	200	-	1400	Ω	At connector
	Y-direction	80	-	1000	Ω	At connector
Insulation Resistance		> 20M Ω				At DC25V
Chatting		≤ 20 ms				At connector
Linearity		$\leq 1.5\%$				(1)

Note 1: Measurement condition of Linearity

Linearity Definition

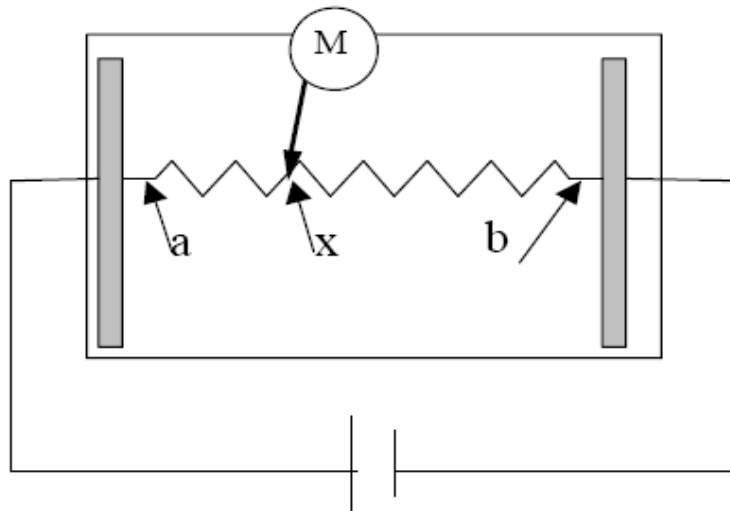

V_a : maximum voltage in the active area of touch panel

V_b: minimum voltage in the active area of touch panel

X : random measuring point

V_{xm}: Actual voltage of L_x point

V_{xi} : Theoretical voltage of L_x point

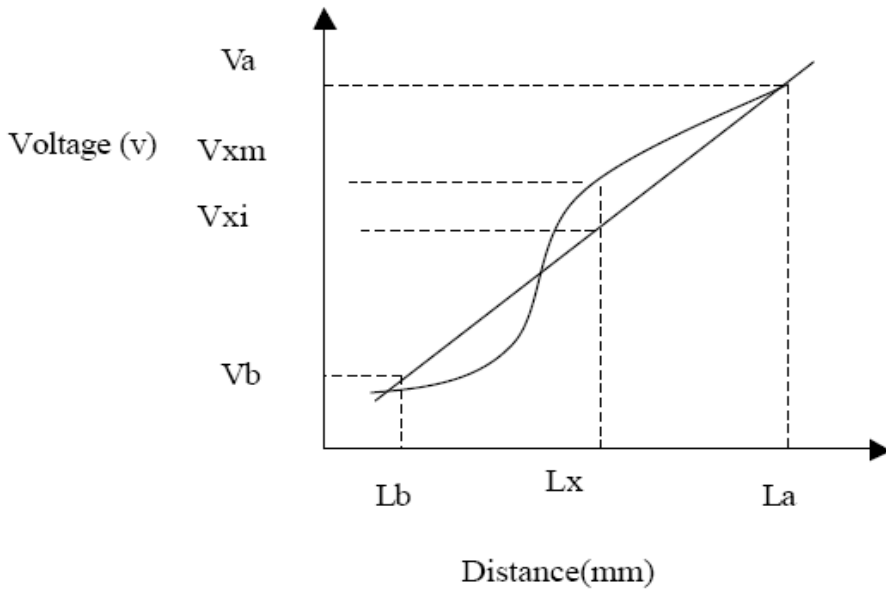

$$\text{Linearity} : [| V_{xi} - V_{xm} | / (V_a - V_b)] * 100\%$$



9. Block Diagram

9.1 TFT-LCD Module with Backlight Unit

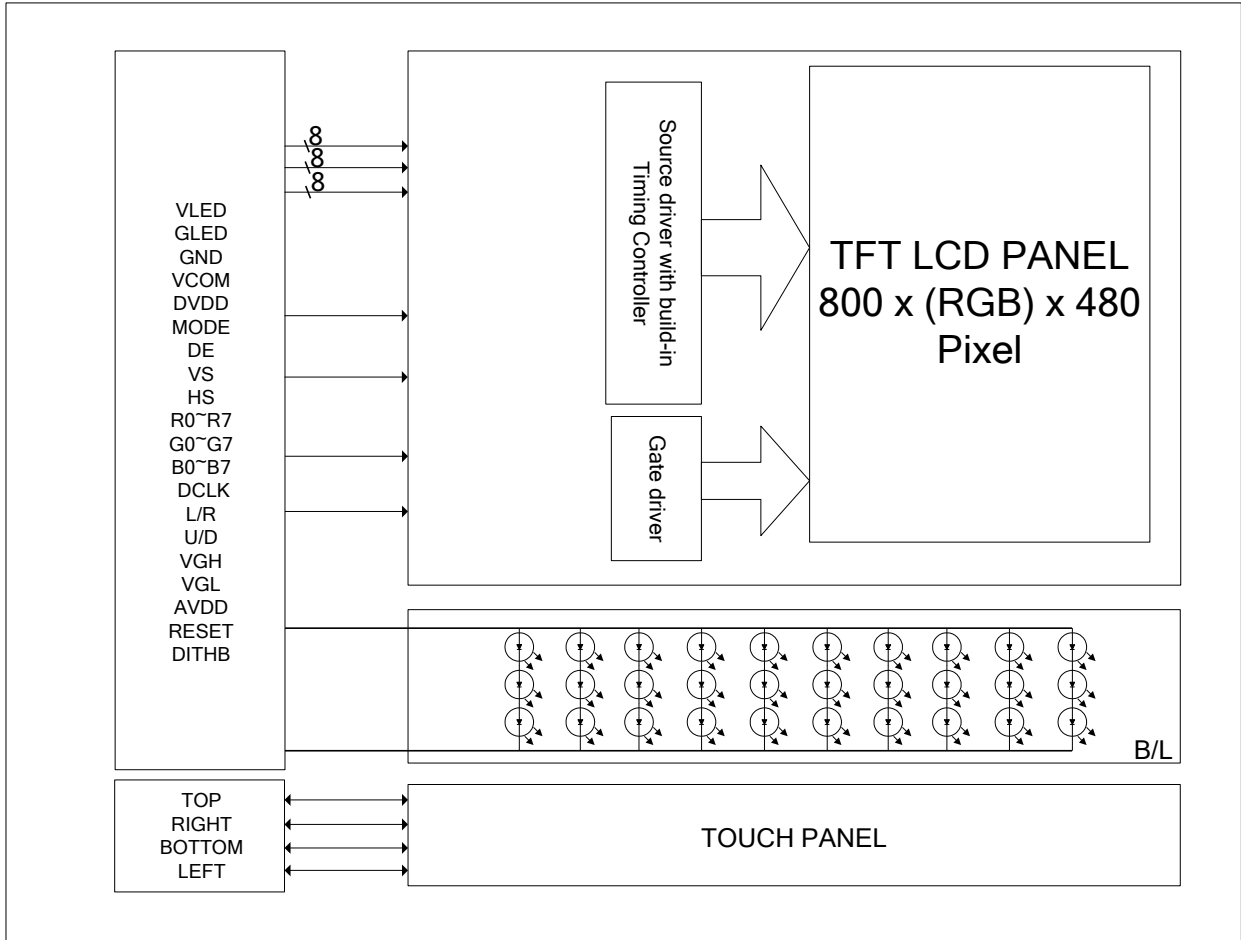



10. Input / Output Terminals Pin Assignment

10.1 TFT-LCD Module

Connector: Hirose FH12A-50S-0.5SH

Pin No.	Symbol	I/O	Description	Remark
1	VLED	-	Power for LED backlight	
2	VLED	-	Power for LED backlight	
3	GLED	-	Ground for LED backlight	
4	GLED	-	Ground for LED backlight	
5	GND	P	Ground	
6	V _{COM}	I	Common voltage	
7	DV _{DD}	P	Power for Digital Circuit	
8	MODE	I	DE/SYNC mode select	Note 1
9	DE	I	Data Input Enable	
10	VS	I	Vertical Sync Input	
11	HS	I	Horizontal Sync Input	
12	B7	I	Blue data(MSB)	
13	B6	I	Blue data	
14	B5	I	Blue data	
15	B4	I	Blue data	
16	B3	I	Blue data	
17	B4	I	Blue data	
18	B1	I	Blue data	Note 2
19	B0	I	Blue data(LSB)	Note 2
20	G7	I	GREEN data(MSB)	
21	G6	I	GREEN data	
22	G5	I	GREEN data	
23	G4	I	GREEN data	
24	G3	I	GREEN data	
25	G2	I	GREEN data	
26	G1	I	GREEN data Note 2	
27	G0	I	GREEN data(LSB) Note 2	
28	R7	I	RED data(MSB)	
29	R6	I	RED data	
30	R5	I	RED data	



Pin No.	Symbol	I/O	Description	Remark
31	R4	I	RED data	
32	R3	I	RED data	
33	R2	I	RED data	
34	R1	I	RED data	Note 2
35	R0	I	RED data (LSB)	Note 2
36	GND	P	Ground	
37	DCLK	I	Sample clock Note 3	
38	GND	P	Ground	
39	L/R	I	Left / right selection	Note 4,5
40	U/D	I	Up / down selection	Note 4,5
41	V _{GH}	P	Gate ON Voltage	
42	V _{GL}	P	Gate OFF Voltage	
43	AV _{DD}	P	Power for Analog Circuit	
44	RESET	I	Global reset pin.	Note 6
45	NC	-	No connection	
46	V _{COM}	I	Common Voltage	
47	DITHB	I	Dithering function	Note 7
48	GND	P	Ground	
49	NC	-	No connection	
50	NC	-	No connection	

I: input, O: output, P: Power

Note 1: DE/SYNC mode select. Normally pull high.

When select DE mode, MODE="1", VS and HS must pull high.

When select SYNC mode, MODE="0", DE must be grounded.

Note 2: When input 18 bits RGB data, the two low bits of R, G and B data must be grounded.

Note 3: Data shall be latched at the falling edge of DCLK.

Note 4: Selection of scanning mode

Setting of scan control input		Scanning direction
U/D	L/R	
GND	DV _{DD}	Up to down, left to right
DV _{DD}	GND	Down to up, right to left
GND	GND	Up to down, right to left
DV _{DD}	DV _{DD}	Down to up, left to right



Note 5: Definition of scanning direction.

Refer to the figure as below:

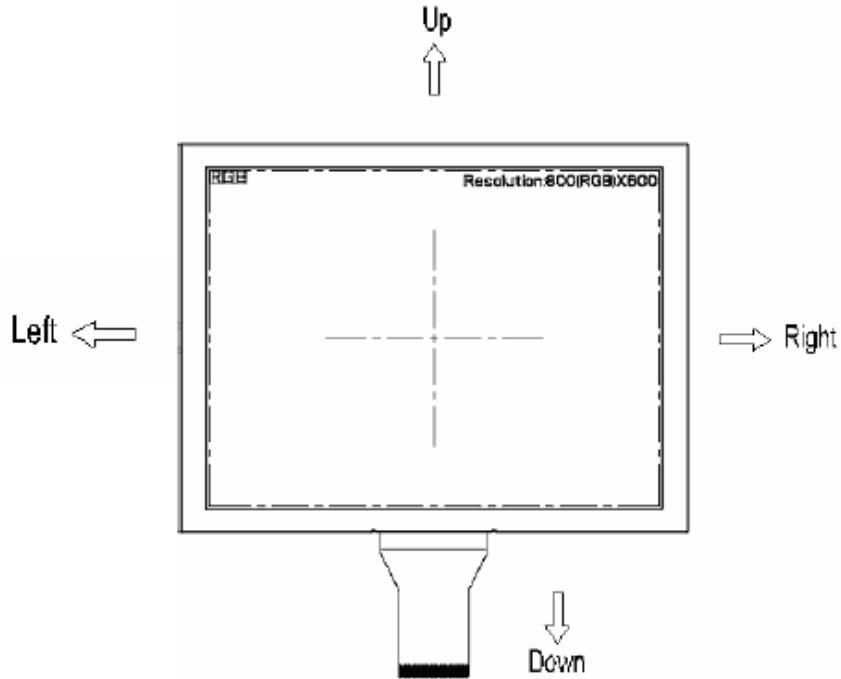

Note 6: Global reset pin. Active low to enter reset state. Suggest to connect with an RC reset circuit for stability. Normally pull high.

Note 7: Dithering function enable control, normally pull high.
When DITHB="1", Disable internal dithering function,
When DITHB="0", Enable internal dithering function,

10.2 Transparent Touch Panel

Connector: CVILUX CF25041D0R0-10

Pin No.	Symbol
1	TOP
2	RIGHT
3	BOTTOM
4	LEFT



10.3 Color Data Input Assignment

The brightness of each primary color(red, green and blue) is based on the 8 bit gray scale data input for the color. The higher the binary input, the brighter the color. The table provides the assignment of color versus data input.

Color		Data Signal																							
		Red								Green								Blue							
		R7	R6	R5	R4	R3	R2	R1	R0	G7	G6	G5	G4	G3	G2	G1	G0	B7	B6	B5	B4	B3	B2	B1	B0
Basic Colors	Black	0	0	0	0	0	0	0	0	0	0	0	0	0	0	0	0	0	0	0	0	0	0	0	
	Red	1	1	1	1	1	1	1	1	0	0	0	0	0	0	0	0	0	0	0	0	0	0	0	
	Green	0	0	0	0	0	0	0	0	1	1	1	1	1	1	1	0	0	0	0	0	0	0	0	
	Blue	0	0	0	0	0	0	0	0	0	0	0	0	0	0	0	1	1	1	1	1	1	1	1	
	Cyan	0	0	0	0	0	0	0	0	1	1	1	1	1	1	1	1	1	1	1	1	1	1	1	
	Magenta	1	1	1	1	1	1	1	1	0	0	0	0	0	0	0	1	1	1	1	1	1	1	1	
	Yellow	1	1	1	1	1	1	1	1	1	1	1	1	1	1	1	0	0	0	0	0	0	0	0	
	White	1	1	1	1	1	1	1	1	1	1	1	1	1	1	1	1	1	1	1	1	1	1	1	
Gray Scale Of RED	Red(0) / Dark	0	0	0	0	0	0	0	0	0	0	0	0	0	0	0	0	0	0	0	0	0	0		
	Red(1)	0	0	0	0	0	0	0	1	0	0	0	0	0	0	0	0	0	0	0	0	0	0		
	Red(2)	0	0	0	0	0	0	1	0	0	0	0	0	0	0	0	0	0	0	0	0	0	0		
	:	:	:	:	:	:	:	:	:	:	:	:	:	:	:	:	:	:	:	:	:	:	:		
	:	:	:	:	:	:	:	:	:	:	:	:	:	:	:	:	:	:	:	:	:	:	:		
	Red(253)	1	1	1	1	1	1	0	1	0	0	0	0	0	0	0	0	0	0	0	0	0	0		
	Red(254)	1	1	1	1	1	1	1	0	0	0	0	0	0	0	0	0	0	0	0	0	0	0		
	Red(255)	1	1	1	1	1	1	1	1	0	0	0	0	0	0	0	0	0	0	0	0	0	0		
Gray Scale Of Green	Green(0) / Dark	0	0	0	0	0	0	0	0	0	0	0	0	0	0	0	0	0	0	0	0	0	0		
	Green(1)	0	0	0	0	0	0	0	0	0	0	0	0	0	0	1	0	0	0	0	0	0	0		
	Green(2)	0	0	0	0	0	0	0	0	0	0	0	0	0	1	0	0	0	0	0	0	0	0		
	:	:	:	:	:	:	:	:	:	:	:	:	:	:	:	:	:	:	:	:	:	:	:		
	:	:	:	:	:	:	:	:	:	:	:	:	:	:	:	:	:	:	:	:	:	:	:		
	Green(253)	0	0	0	0	0	0	0	0	1	1	1	1	1	1	0	1	0	0	0	0	0	0		
	Green(254)	0	0	0	0	0	0	0	0	1	1	1	1	1	1	0	0	0	0	0	0	0	0		
	Green(255)	0	0	0	0	0	0	0	0	1	1	1	1	1	1	1	0	0	0	0	0	0	0		
Gray Scale Of Blue	Blue(0) / Dark	0	0	0	0	0	0	0	0	0	0	0	0	0	0	0	0	0	0	0	0	0	0		
	Blue(1)	0	0	0	0	0	0	0	0	0	0	0	0	0	0	0	0	0	0	0	0	0	1		
	Blue(2)	0	0	0	0	0	0	0	0	0	0	0	0	0	0	0	0	0	0	0	0	0	1		
	:	:	:	:	:	:	:	:	:	:	:	:	:	:	:	:	:	:	:	:	:	:	:		
	:	:	:	:	:	:	:	:	:	:	:	:	:	:	:	:	:	:	:	:	:	:	:		
	Blue(253)	0	0	0	0	0	0	0	0	0	0	0	0	0	0	0	1	1	1	1	1	1	0		
	Blue(254)	0	0	0	0	0	0	0	0	0	0	0	0	0	0	0	1	1	1	1	1	1	0		
	Blue(255)	0	0	0	0	0	0	0	0	0	0	0	0	0	0	0	1	1	1	1	1	1	1		



11. Interface Timing

11.1 Input Signal Characteristics

Item	Symbol	Values			Unit	Remark
		Min.	Typ.	Max.		
HS setup time	T_{hst}	8	-	-	ns	
HS hold time	T_{hhd}	8	-	-	ns	
VS setup time	T_{vst}	8	-	-	ns	
VS hold time	T_{vhd}	8	-	-	ns	
Data setup time	T_{dsu}	8	-	-	ns	
Data hole time	T_{dhd}	8	-	-	ns	
DE setup time	T_{esu}	8	-	-	ns	
DE hole time	T_{ehd}	8	-	-	ns	
DV _{DD} Power On Slew rate	T_{POR}	-	-	20	ms	From 0 to 90% DV _{DD}
RESET pulse width	T_{Rst}	1	-	-	ms	
DCLK cycle time	T_{coh}	20	-	-	ns	
DCLK pulse duty	T_{cwh}	40	50	60	%	



11.2 Power Sequence

Power on:

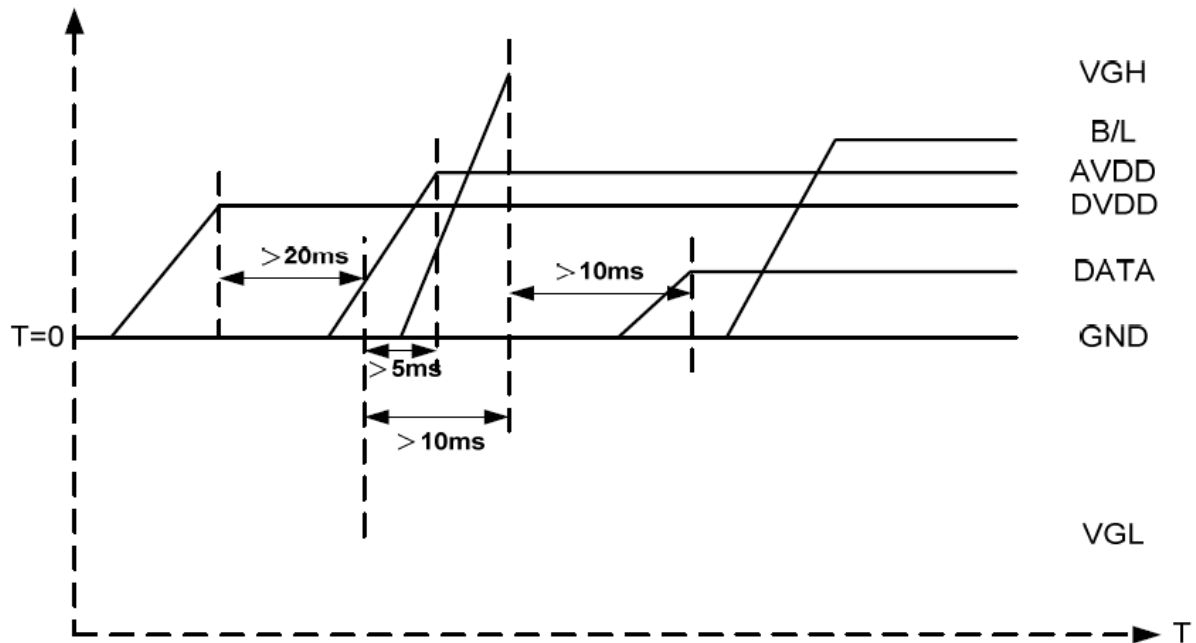

DVDD → VGL → VGH → Data → B/L

Power off:

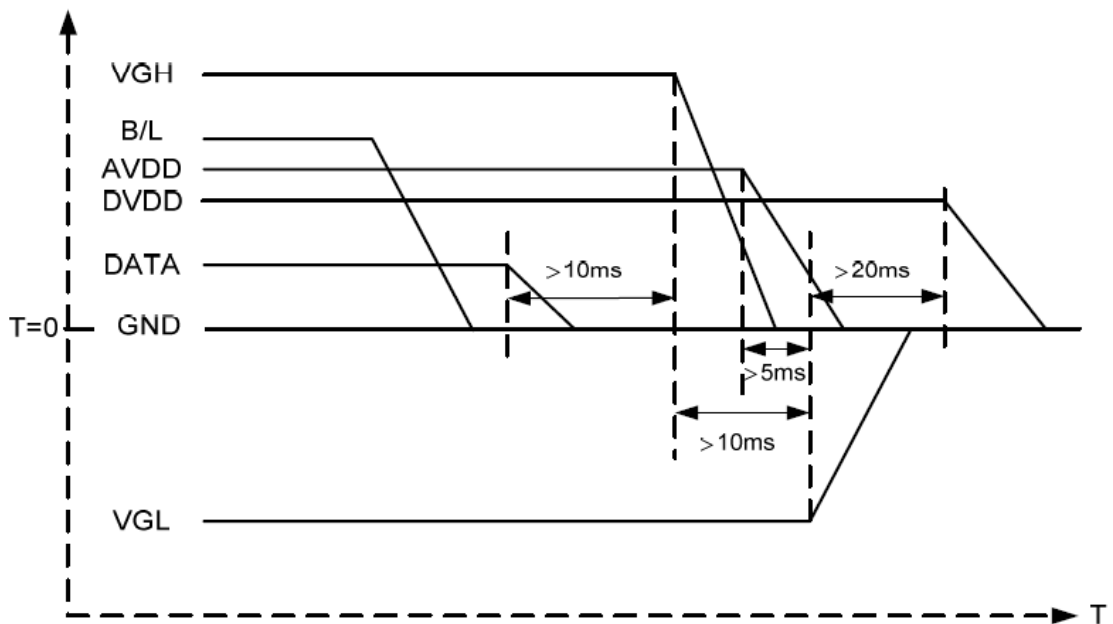

B/L → Data → VGH → VGL → DVDD

Note: Data include R0~R7, B0~B7, GO~G7, U/D, L/R, DCLK, HS, VS, DE.

**11.3 Timing**

Item	Symbol	Values			Unit	Remark
		Min.	Typ.	Max.		
Horizontal Display Area	thd	-	800	-	DCLK	
DCLK Frequency	fclk	26.4	33.3	46.8	MHz	
One Horizontal Line	th	862	1056	1200	DCLK	
HS pulse width	thpw	1	-	40	DCLK	
HS Blanking	thb	46	46	46	DCLK	
HS Front Porch	thfp	16	210	354	DCLK	

Item	Symbol	Values			Unit	Remark
		Min.	Typ.	Max.		
Vertical Display Area	tvd	-	480	-	TH	
VS period time	tv	510	525	650	TH	
VS pulse width	tvpw	1	-	20	TH	
VS Blanking	tvb	23	23	23	TH	
VS Front Porch	tvfp	7	22	147	TH	



11.4 Waveform

11.4.1 Data input format



Horizontal input timing diagram.

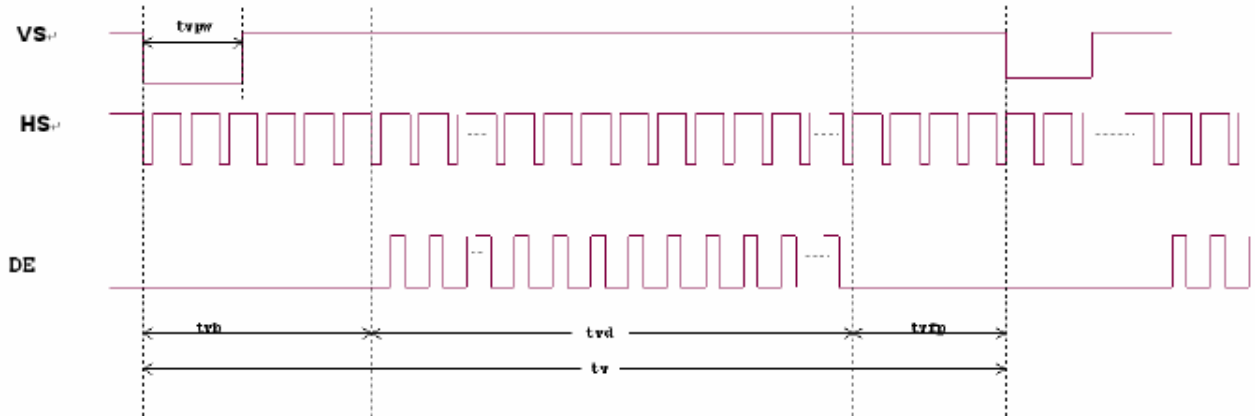

Vertical input timing diagram.

**12. Optical Characteristics**

The optical characteristics should be measured in a dark environment (≤ 1 lux) or equivalent state with the methods shown in Note (4).

Item		Symbol	Conditions	Min.	Typ.	Max.	Unit	Note	
Contrast Ratio		CR	Viewing Normal Angle	400	(500)	-	-	(2)	
Response Time		T_R		-	10	20	ms	(3)	
		T_F		-	15	30	ms		
Luminance(Center)		Y		$\theta_x=0^\circ, \theta_y=0^\circ$	150	(200)	-	cd/m ²	(4)
Brightness uniformity		BUNI			70	(75)	-	%	(5)
Color Chromaticity	White	W_x	CR \geq 10	0.26	0.31	0.36	-	(1),(4)	
		W_y		0.28	0.33	0.38	-		
Viewing Angle	Horizontal	θ_{x+}		60	(70)	-	deg.		
		θ_{x-}		60	(70)	-			
	Vertical	θ_{y+}		40	(50)	-			
		θ_{y-}		60	(70)	-			



Note (1) Definition of Viewing Angle (θ_x, θ_y):

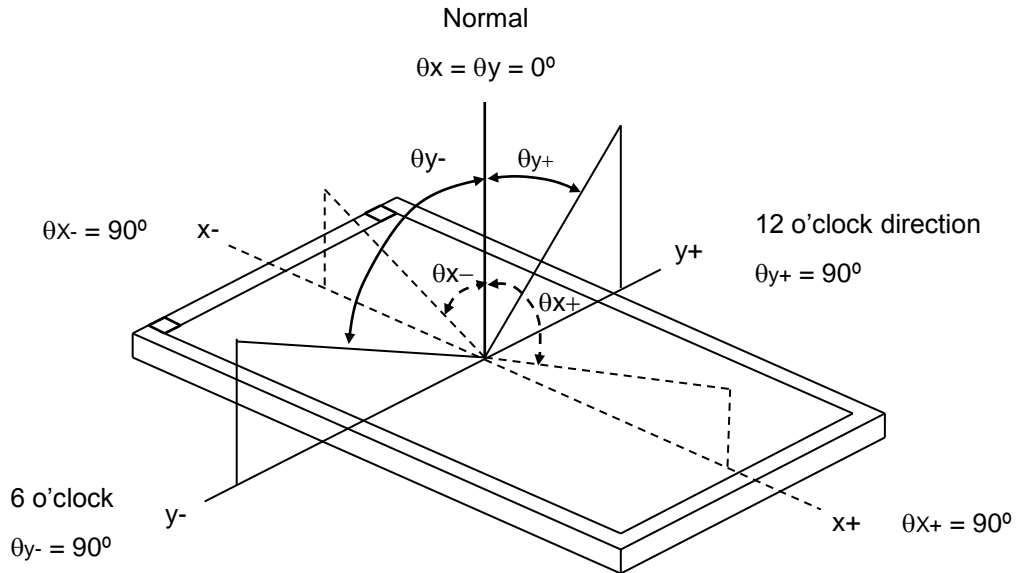

Note (2) Definition of Contrast Ratio (CR):

$$\text{Contrast ratio (CR)} = \frac{\text{Luminance measured when LCD on the "White" state}}{\text{Luminance measured when LCD on the "Black" state}}$$

Note (3) Definition of Response Time (T_R, T_F):

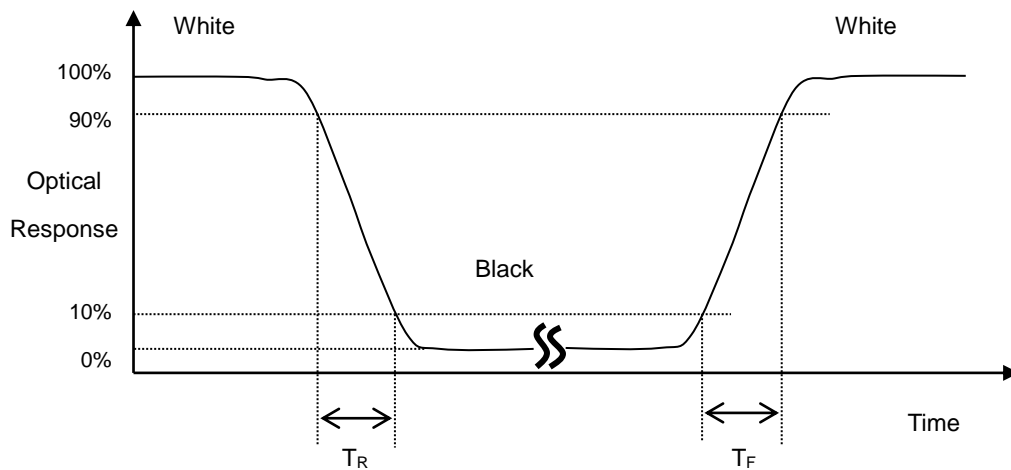



Note (4) Measurement Set-Up:

The LCD module should be stabilized at a given temperature for 30 minutes to avoid abrupt temperature change during measuring. In order to stabilize the luminance, the measurement should be executed after lighting Backlight for 30 minutes in a windless room.

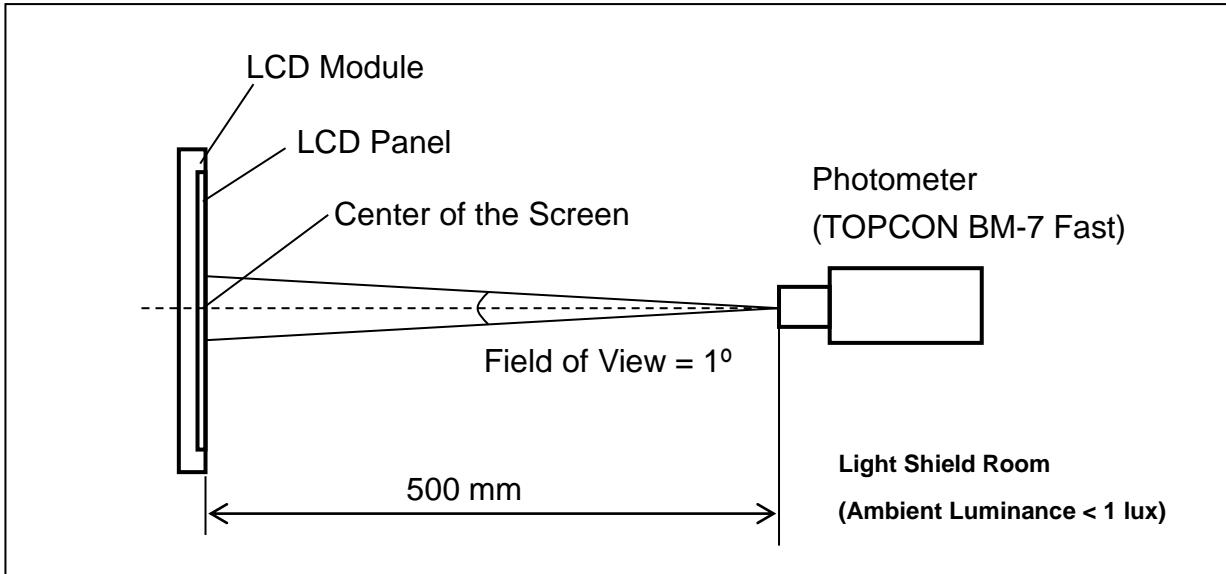

Note (5) Definition of brightness uniformity

Brightness uniformity=(Min Luminance of 9 points)/(Max Luminance of 9 points)×100%

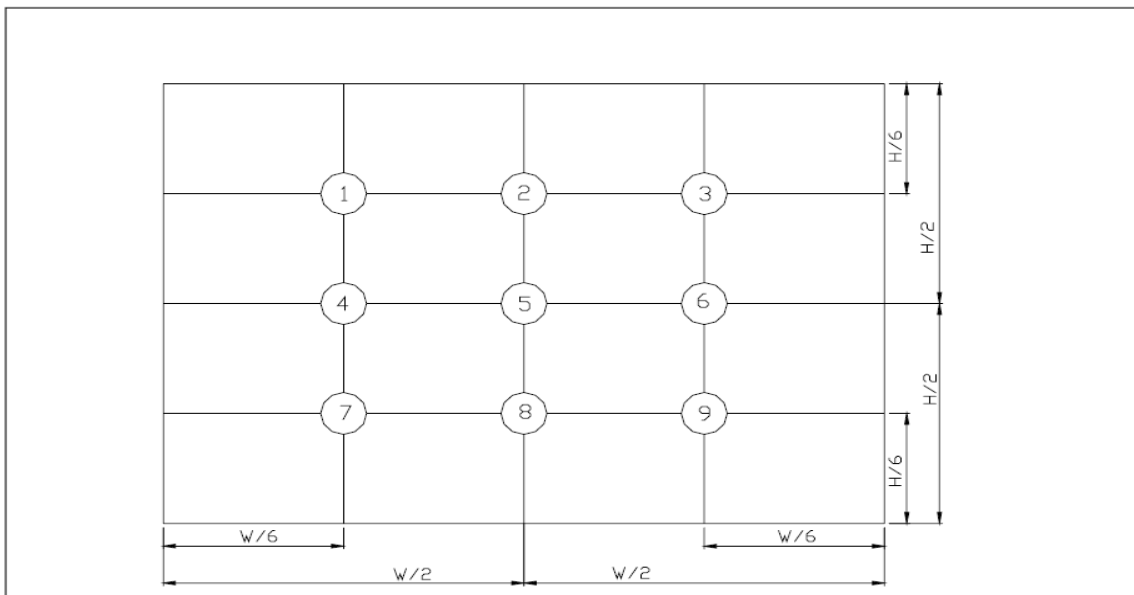

(單位 : mm)

**13. Reliability Test**

(Note3)

Item	Test Conditions	Remark
High Temperature Storage	Ta = 80°C 240hrs	Note 1, Note 4
Low Temperature Storage	Ta = -30°C 240hrs	Note 1, Note 4
High Temperature Operation	Ts = 70°C 240hrs	Note 2, Note 4
Low Temperature Operation	Ta = -20°C 240hrs	Note 1, Note 4
Operate at High Temperature and Humidity	+60°C, 90%RH 240hrs	Note 4
Thermal Shock	-30°C/30 min ~ +80°C/30 min for a total 100 cycles, Start with cold temperature and end with high temperature.	Note 4
Vibration Test	Frequency range:10~55Hz Stroke:1.5mm Sweep:10Hz~55Hz~10Hz 2 hours for each direction of X. Y. Z. (6 hours for total)	
Mechanical Shock	100G 6ms,±X, ±Y, ±Z 3 times for each direction	
Package Vibration Test	Random Vibration : 0.015G*G/Hz from 5-200HZ, -6dB/Octave from 200-500HZ 2 hours for each direction of X. Y. Z. (6 hours for total)	
Package Drop Test	Height:60 cm 1 corner, 3 edges, 6 surfaces	
Electro Static Discharge	± 2KV, Human Body Mode, 100pF/1500Ω	

Note 1: Ta is the ambient temperature of samples.

Note 2: Ts is the temperature of panel's surface.

Note 3: In the standard condition, there shall be no practical problem that may affect the display function. After the reliability test, the product only guarantees operation, but don't guarantee all of the cosmetic specification.

Note 4: Before cosmetic and function test, the product must have enough recovery time, at least 2 hours at room temperature.



14. Packaging

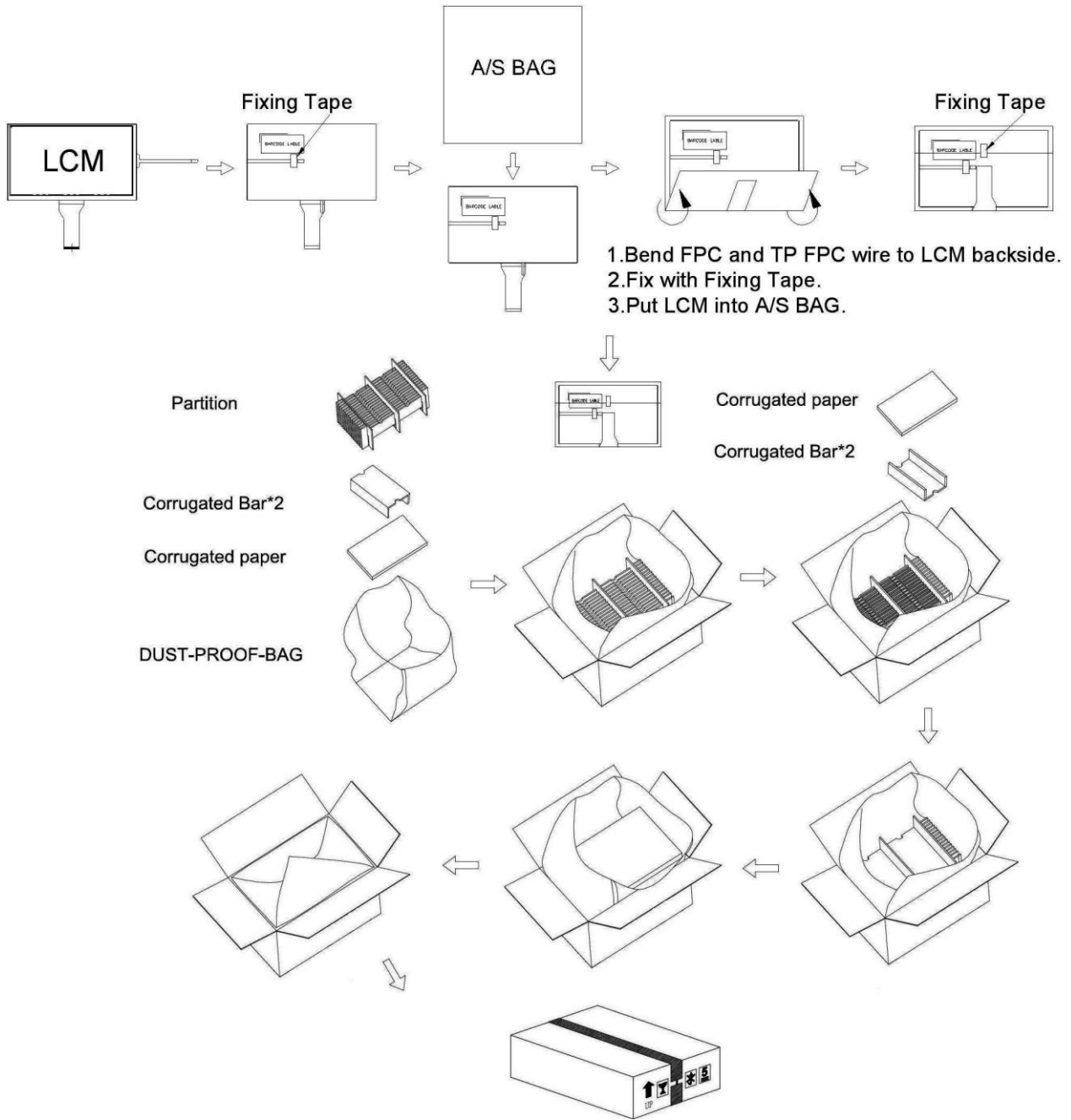

PARTS LIST					
	ITEM	SIZE(LxWxH) unit:mm	MATERIAL	Q.T.Y	NOTE
1	PARTITION	512.0x349.0x226.0	CORRUGATED PAPER	1	
2	CORRUGATED PAPER	510.0x350.0	CORRUGATED PAPER	2	
3	CORRUGATED BAR	349.0x118.0x44.0	CORRUGATED PAPER	4	
4	DUST-PROOF BAG	700.0x530.0	PE	1	
5	A/S BAG	240.0x230.0	PE	30	
6	CARTON	460.0x360.0x355.0	CORRUGATED PAPER	1	
7	PRODUCT	211.1x126.5x7.5		30	



15. Precautions

15.1 Assembly and Handling Precautions

- (1) Do not apply rough force such as bending or twisting to the module during assembly.
- (2) It's recommended to assemble or to install a module into the user's system in clean working areas. The dust and oil may cause electrical short or worsen the polarizer.
- (3) Don't apply pressure or impulse to the module to prevent the damage of LCD panel and Backlight.
- (4) Always follow the correct power-on sequence when the LCD module is turned on. This can prevent the damage and latch-up of the CMOS LSI chips.
- (5) Do not plug in or pull out the I/F connector while the module is in operation.
- (6) Do not disassemble the module.
- (7) Use a soft dry cloth without chemicals for cleaning, because the surface of polarizer is very soft and easily scratched.
- (8) Moisture can easily penetrate into LCD module and may cause the damage during operation.
- (9) High temperature or humidity may deteriorate the performance of LCD module. Please store LCD module in the specified storage conditions.
- (10) When ambient temperature is lower than 10°C, the display quality might be reduced. For example, the response time will become slow.

15.2 Safety Precautions

- (1) If the liquid crystal material leaks from the panel, it should be kept away from the eyes or mouth. In case of contact with hands, skin or clothes, it has to be washed away thoroughly with soap.
- (2) After the module's end of life, it is not harmful in case of normal operation and storage.

15.3 Terms of Warrant

- (1) Acceptance inspection period
The period is within one month after the arrival of contracted commodity at the buyer's factory site.
- (2) Applicable warrant period
The period is within twelve months since the date of shipping out under normal using and storage conditions.



15.4 Cautions for installing and assembling

Bezel edge must be positioned in the area between the Active area and View area. The bezel may press the touch screen and cause activation if the edge touches the active area. A gap of approximately 0.5mm is needed between the bezel and the top electrode. It may cause unexpected activation if the gap is too narrow. There is a tolerance of 0.2 to 0.3mm for the outside dimensions of the touch panel and tail. A gap must be made to absorb the tolerance in the case and connector.

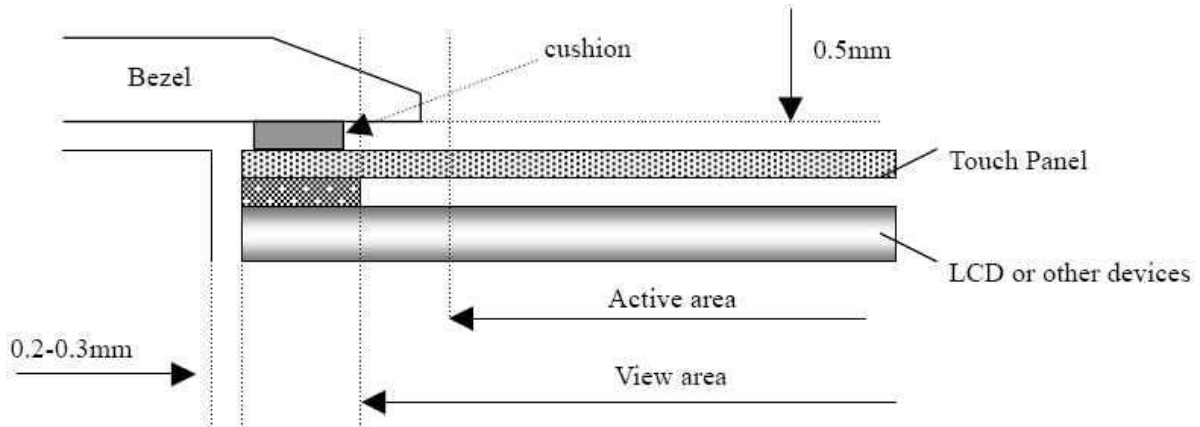

15.5 Operation Prohibit

Not Suggested Pen Input Position On Touch Panel

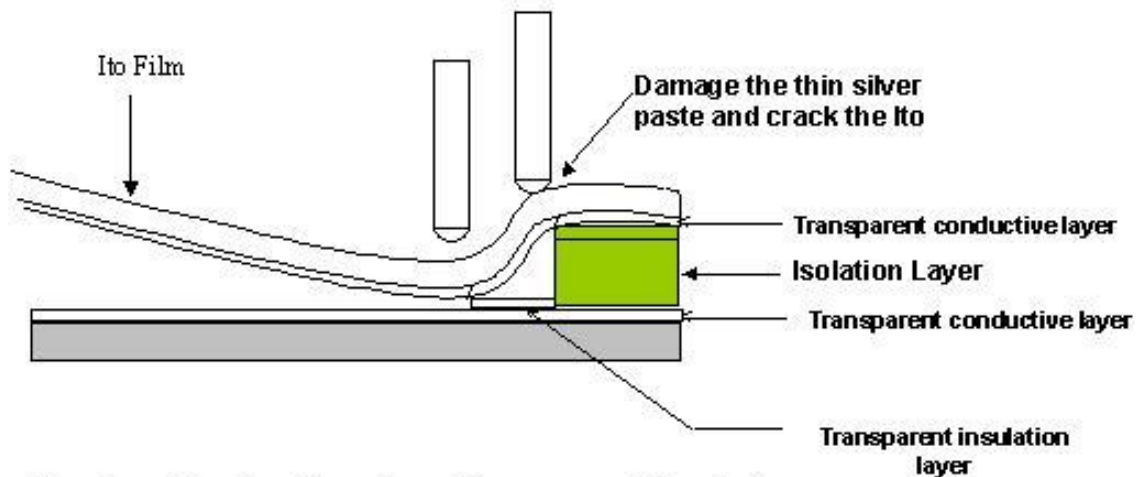

Pen input load on the edge of transparent insulation area might damage the ITO of ITO Pet- Film and reduce the durability of touch panel



16.Outline Drawing

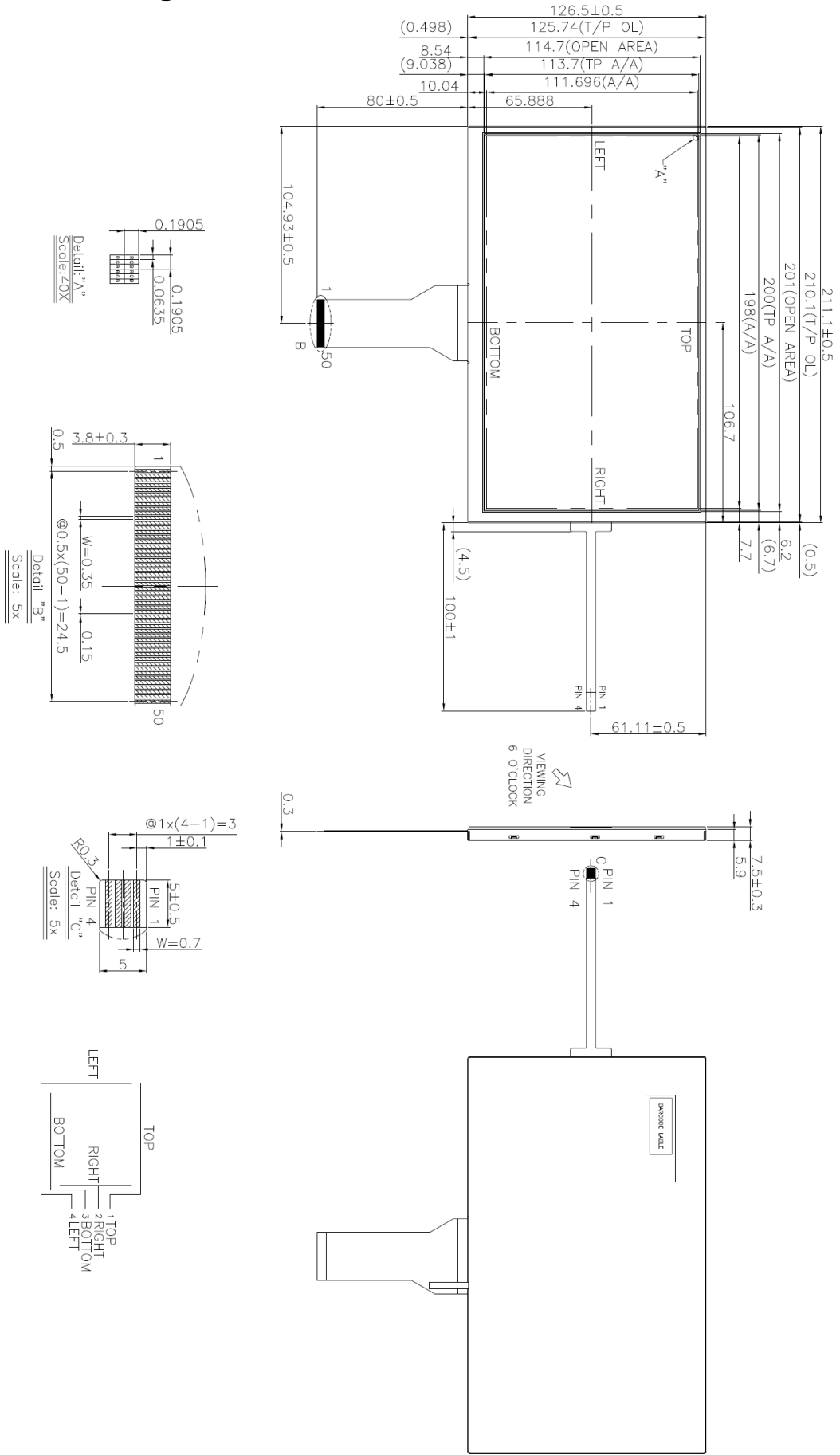



17. Definition of Labels

The bar code nameplate is pasted on each module as illustration, and its definitions are as following explanation.

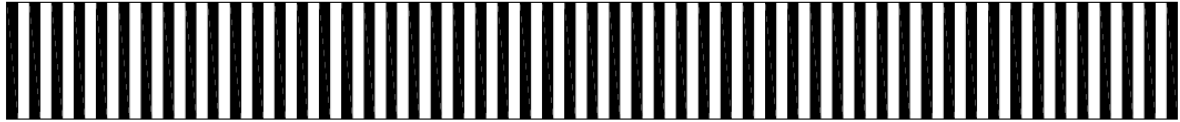

PT804890B-TLMWD-ER09

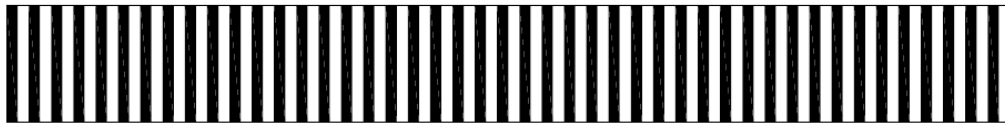

ABCDEFGHIJKLM

(a) Module Name: PT804890B-TLMWD-ER09

(b) Serial ID:

A B C D E F G H I J K L M

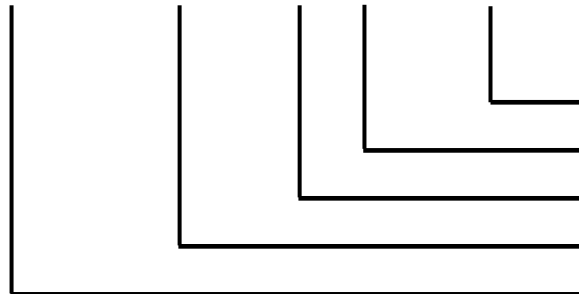

Serial No.
Revision Code
Factory Code
Manufactured Date
Screen Size

Serial ID includes the information as below:

(a) Screen size (Diagonal): Inch Code (ABCD)

3.5" → 0350

10.4" → 1040

(b) Manufactured Date: Year, Month, Day (EFG)

Year (E)

Year	2000	2001	2002	2003	2004	2005	2006	2007	2008	2009
Mark	0	1	2	3	4	5	6	7	8	9
Year	2010	2011	2012	2013	2014	2015	2016	2017	2018	2019
Mark	A	B	C	D	E	F	G	H	I	J



Month (F)

Month	Jan.	Feb.	Mar.	Apr.	May	Jun.	Jul.	Aug.	Sep.	Oct.	Nov.	Dec.
Mark	1	2	3	4	5	6	7	8	9	A	B	C

Day (G)

Day	1	2	3	4	5	6	7	8	9	10	11	12	13	14	15	16
Mark	1	2	3	4	5	6	7	8	9	A	B	C	D	E	F	G
Day	17	18	19	20	21	22	23	24	25	26	27	28	29	30	31	
Mark	H	I	J	K	L	M	N	O	P	Q	R	S	T	U	V	

(c) Factory Code (H):

For P-TEC internal use.

(d) Revision Code (I):

Cover all the change, for example: 1: Rev.1, 2: Rev.2, 3: Rev.3...etc.

(e) Serial No. (JKLM):

Manufacturing sequence of product, for example: 0001~9999.



18. Incoming Inspection Standards

18.1 Inspection Parameters

1. Incoming Inspection

Both parties agree that the inspection specifications of TFT-LCD Modules (hereinafter known as "Modules") stipulated hereunder is the only and final standard applicable in the process of inspection. P-TEC shall be under no liability or obligation (including incidental loss, products liability or other consequential loss) whatsoever for any defect in quality or performance or shortage in quantity of the Modules that have passed such inspection.

2. Liability

2.1 Inspection Deadline

The Customer should inspect the Modules either at the Delivery Point or within twenty (20) calendar days after arrival at the Delivery Destination.

2.2 Notification of Rejection

The Customer may reject one or more defective or non-conforming Modules if the Modules fail to meet the AQL (Acceptable Quality Level) and pass the inspection. In that case, the customer should notify P-TEC of the rejection by either documents or mail within in three (3) business days from the date of reception of the Modules. Otherwise, the Modules shall be deemed to have met the AQL and passed the inspection.

3. Inspection Specifications

Both parties agree that the inspection shall contain and follow the inspection specifications stipulated in the attachment, including:

3.1 Scope

3.2 Sampling Plan

3.3 Panel Inspection Condition

3.4 Display Quality

3.5 Mechanics Specifications

3.6 Notification for Storage Handling

4. Limited Warranty

P-TEC represents and warrants that all Modules shall (i) conform to the specifications set hereunder, and (ii) be free from any defects in material and workmanship for twelve (12) months after the Customer's acceptance or deemed acceptance. P-TEC will replace, rework or refund the Customer for the defective or non-conforming Modules at P-TEC's option, provided that the Customer (i) promptly informs P-TEC of the defects or non-conformities within the warranty period, (ii) complies with the specifications and conditions hereunder, and (iii) complies with P-TEC's procedure for Modules replacement, reworking and/or return. The warranty period for the Modules replaced



P-TEC

MODEL NO.

PAGE

PT804890B-TLMWD-ER09

SPEC SAMPLE

31

or reworked shall be the remaining term for such Modules.

5. THE WARRANTIES AND REMEDIES SET FORTH ABOVE ARE EXCLUSIVE AND IN LIEU OF ALL OTHER WARRANTIES, TERMS OR CONDITIONS, EXPRESS OR IMPLIED, EITHER IN FACT OR BY OPERATION OF LAW, STATUTORY OR OTHERWISE, INCLUDING WARRANTIES OR CONDITIONS OF MERCHANTABILITY AND FITNESS FOR A PARTICULAR PURPOSE, ALL OF WHICH ARE EXPRESSLY DISCLAIMED. P-TEC'S WARRANTIES HEREIN APPLY ONLY TO THE CUSTOMER AND ARE NOT TO BE EXTENDED TO ANY THIRD PARTY.

6. Governing Law

This Agreement shall be governed and construed in accordance with the laws of the Republic of China. Both parties agree to submit any dispute, which cannot be amicably resolved, to Hsinchu District Court for the first instance.



Inspection Specifications

1. Scope

Specifications contain

- 1.1 Display Quality Evaluation
- 1.2 Mechanics Specification

2. Sampling Plan

Unless there is other agreement, the sampling plan for incoming inspection shall follow MIL-STD-105E.

- 2.1 Lot size: Quantity per shipment as one lot (different model as different lot).
- 2.2 Sampling type: Normal inspection, single sampling.
- 2.3 Sampling level: Level II.
- 2.4 AQL: Acceptable Quality Level
 - Major defect: AQL=0.65
 - Minor defect: AQL=1.0

3. Panel Inspection Condition

3.1 Environment:

Room Temperature: $25\pm 5^{\circ}\text{C}$.

Humidity: $65\pm 5\%$ RH.

Illumination: 300 ~ 700 Lux.

3.2 Inspection Distance:

35 ± 5 cm

3.3 Inspection Angle:

The vision of inspector should be perpendicular to the surface of the Module.

3.4 Inspection time:

Perceptibility Test Time: 20 seconds max.

4. Display Quality

4.1 Function Related:

The function defects of line defect, abnormal display, and no display are considered Major defects.



4.2 Bright/Dark Dots:

Defect Type	Specification	Major	Minor
Bright Dots	$N \leq 3$		•
Dark Dots	$N \leq 4$		•
Total Bright and Dark Dots	$N \leq 6$		•

Note: 1: The definition of dot: The size of a defective dot over 1/2 of whole dot is regarded as one defective dot.

Bright dot: Dots appear bright and unchanged in size in which LCD panel is displaying under black pattern.

The bright dot defect must be visible through 2% ND filter

Dark dot: Dots appear dark and unchanged in size in which LCD panel is displaying under pure red, green, blue pattern.

4.3 Pixel Definition:

R		B	R	G	B	R	G	B		Dot Defect
R	G	B	R		B	R	G	B		Adjacent Dot Defect
	R	G		R	G	B		Cluster		

Note

1: If pixel or partial sub-pixel defects exceed 50% of the affected pixel or sub-pixel area, it shall be considered as 1 defect.



Note 2: There should be no distinct non-uniformity visible through 2% ND Filter within 2 sec inspection times.

4.4 Visual Inspection specifications:

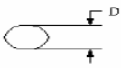
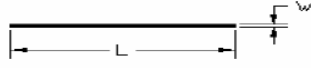

<u>Defect Type</u>	<u>Specification Size</u>	<u>Count(N)</u>	Major	Minor
Dot Shape (Particle · Scratch and Bubbles in display area) 	$D \leq 0.3 \text{ mm}$	Ignored		•
	$0.3\text{mm} < D \leq 0.5\text{mm}$	$N \leq 4$		
	$D > 0.5\text{mm}$	$N=0$		
Line Shape (Particles · Scratch · Lint and Bubbles in display area) 	$W \leq 0.07 \text{ mm}$	Ignored		•
	$0.07\text{mm} < W \leq 0.1\text{mm}$ and $L \leq 5\text{mm}$	$N \leq 4$		
	$W > 0.10\text{mm}$ or $L > 5\text{mm}$	$N=0$		
Bubble in cell (active area)	It should be found by eyes			•
Bezel	Scratch	No harm		•
	Dirt			•
	Wrap			•
	Sunken			•
Label	No label	No		•
	Inverted label			•
	Broken			•
	Dirt	Word can be read.		•
	Not clear	No		•
	Word out of shape			•
	Mistake			•
	Position	Be attached on right position		•
Screw	Not enough	No		•
	Limp	No		•

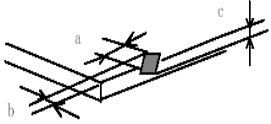
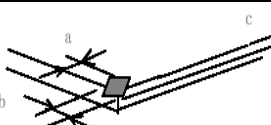

Item		Specification/Description			Note
Touch Panel	Scratch	L(mm)	W(mm)	Acceptable number	Note:2
		$L \leq 10$	$W < 0.05$	Disregard	
			$0.05 \leq W < 0.1$	$N \leq 4$	
			$W \geq 0.1$	0	
	Foreign Materials (Linear shape)	$L \leq 10$	$W < 0.05$	Disregard	Note:2
			$0.05 \leq W < 0.1$	$N \leq 3$	
			$W \geq 0.1$	0	
	Foreign Materials (Circular shape)	Dimension(mm)		Acceptable number	Note:3
		$D \leq 0.25$		Disregard	
		$0.25 < D \leq 0.5$		$N \leq 6$	
$D > 0.5$		0			
Glass chipping		$a \leq 5.0\text{mm}$		Note:7	
		$b \leq 3.0\text{mm}$			
Glass chipping		$a \leq 3.0\text{mm}$		Note:7	
		$b \leq 3.0\text{mm}$			
Newton-ring	(In case of doubtful situations) Observe on 60° from the product surface under a white Fluorescent lamp (3-wavelength lamp).	Average diameter $\leq 1/3$ Touch Panel area Disregard.		Note:7	
					
Membrane Drum		$H \leq 0.4\text{mm}$			



Connector	Connection status	No bend on pins and damage		•
FPC/FFC	Broken	No		•

Note: Extraneous substance and scratch not affecting the display of image, for instance, extraneous substance under polarizer film but outside the display area, or scratch on metal bezel and backlight module or polarizer film outside the display area, shall not be considered as defective or non-conforming.

5. Mechanics specifications

As for the outside dimensions and weight of the Modules, please refer to product specifications for more details.

6. Notification for Storage Handling

6.1 Storage:

6.1.1 Environment condition must be within the product specifications, otherwise the Module might be damaged.

6.1.2 Pile of stacking shall follow the instruction of P-TEC.

6.2 Handling:

6.2.1 Twisting or Bending of the Module is prohibited.

6.2.2 All chemicals are unfit for use unless otherwise instructed by P-TEC.

6.2.3 Plugging in & unplugging:

The power must be turned off before plugging in or unplugging the Module.

6.2.4 ESD protection:

The Module must not be touched without proper grounding.

6.2.5 High Voltage:

The rear side of Module must not be touched without protection.

6.2.6 Power sequence:

Shall follow the instruction of P-TEC.



18.2 Handling of LCM

- (1) Don't give external shock.
- (2) Don't apply excessive force on the surface.
- (3) Liquid in LCD is hazardous substance. Must not lick and swallow. when the liquid is attach to your hand, skin, cloth etc. Wash it out thoroughly and immediately.
- (4) Don't operate it above the absolute maximum rating.
- (5) Don't disassemble the LCM.