

## *ALD12/18/20/25 Single Output 16<sup>th</sup> Brick: 60Watts*

The ALD12/18/20/25 series is Astec's latest 16<sup>th</sup> Brick industry standard offering. Operating from an input voltage range of 36V to 75V, the series provides 6 configured outputs from 1.2V all the way up to 5V. It delivers up to 25A max current for 1.8V and lower at impressive levels of efficiency. The series comes with industry standard features such as Input UVLO; non-latching OCP, OVP and OTP; Output Trim; Differential Remote Sense pins. With its wide operating temperature range of -40°C to 85°C ambient, the converters are deployable into almost any environment.



### Special Features

- Industry Standard 16<sup>th</sup> Brick Footprint
- Low Ripple and Noise
- Output pre-bias startup
- Regulation to zero load
- High Capacitive Load Start-up
- Fixed Switching Frequency
- Industry standard features: Input UVLO; Enable; non-latching OVP, OCP and OTP; Output Trim, Differential Remote Sense
- Meets Basic Insulation

### Environmental Specifications

- -40°C to 85°C Operating Temperature
- -40°C to 125°C Storage Temperature
- MTBF > 1 million hours

### Electrical Parameters

#### Input

Input Range	36-75 VDC
Input Surge	100V / 100ms

#### Control

Enable	TTL compatible
(Positive or Negative Logic Enable Options)	

#### Output

Load Current	Up to 25A max ( $V_O \leq 1.8V$ )
Line/Load Regulation	< 1% $V_O$
Ripple and Noise	40mV <sub>P-P</sub> typical
Adjust Range	±10% $V_O$
Transient Response	3% Typical deviation 50% to 75% Load Change 80µs settling time (Typ)
Remote Sense	+10% $V_O$
Over Current Protection	120% max
Over Voltage Protection	130% max
Over Temperature Protection	110 °C

### Safety

UL + cUL 60950, Recognized  
 EN60950 through TUV-PS



# Technical Reference Notes

## ALD12/18/20/25 Series

### (Single Output 16<sup>th</sup> Brick)



## Electrical Specifications

### ABSOLUTE MAXIMUM RATINGS

Stresses in excess of the absolute maximum ratings can cause permanent damage to the converter. Functional operation of the device is converter is not implied at these or any other conditions in excess of those given in the operational section of the specs. Exposure to absolute maximum ratings for extended period can adversely affect device reliability.

Parameter	Device	Symbol	Min	Typ	Max	Unit
Input Voltage <sup>1</sup>						
Continuous	All	$V_{IN}$	-0.3	-	75	Vdc
Transient (100ms)		$V_{IN,trans}$	-	-	100	
Isolation Voltage						
Input to Output	All		1500	-	-	Vdc
Operating Temperature	All	$T_a$	-40	-	85	°C
Storage Temperature	All	$T_{STG}$	-40	-	125	°C
Operating Humidity	All	-	10	-	85	%
Max Voltage at Enable Pin	All		-0.6	-	25	Vdc
Max Output Power	A (5V0)		-	-	60	W
	F (3V3)		-	-	60	W
	G (2V5)		-	-	50	W
	Y (1V8)		-	-	45	W
	M (1V5)		-	-	38	W
	K (1V2)		-	-	30	W

### INPUT SPECIFICATIONS

Parameter	Device	Symbol	Min	Typ	Max	Unit
Operating Input Voltage Range	All	$V_{IN}$	36	48	75	Vdc
Input Under-Voltage Lock-out	All					
T_ON Threshold			34.0	34.8	36.0	Vdc
T_OFF Threshold			31.0	32.5	33.5	
Input Current <sup>1</sup>						
( $V_{IN} = V_{IN, Min}$ ; $I_O = I_{O, Max}$ )	5V0 (A)	$I_{IN-MAX}$	-	-	2.4	A
	3V3 (F)		-	-	2.4	
	2V5 (G)		-	-	1.9	
	1V8 (Y)		-	-	1.6	
	1V5 (M)		-	-	1.4	
	1V2 (K)		-	-	1.1	
Max $P_{diss}$ @ $I_O = 0A$						
( $V_{IN} = V_{IN, Nom}$ ; $T_A \geq 25^\circ C$ )	5V0 (A)		-	-	4.1	W
	3V3 (F)		-	-	3.9	
	2V5 (G)		-	-	3.4	
	1V8 (Y)		-	-	3.4	
	1V5 (M)		-	-	3.4	
	1V2 (K)		-	-	2.6	
Input Ripple Current <sup>2</sup>	All	$I_{rl}$	-	-	10	mAp-p
5Hz to 20MHz						
Input Voltage Rise Time	All		-	1	-	V/ms
10% to 90% of $V_{out}$						
Inrush Current	All	$I^2/s$	-	-	1	$A^2/s$



**Technical Reference Notes**  
**ALD12/18/20/25 Series**  
**(Single Output 16<sup>th</sup> Brick)**



**Electrical Specifications (continued)**

**OUTPUT SPECIFICATIONS**

Parameter	Device	Symbol	Min	Typ	Max	Unit	
Output Voltage Set point $V_{IN} = V_{IN, MIN}$ to $V_{IN, MAX}$ ; $I_O = I_{O, MAX}$	5V0 (A)	$V_{O, SET}$	4.930	5.000	5.070	Vdc	
	3V3 (F)		3.260	3.300	3.340	Vdc	
	2V5 (G)		2.465	2.500	2.535	Vdc	
	1V8 (Y)		1.770	1.800	1.830	Vdc	
	1V5 (M)		1.470	1.500	1.530	Vdc	
	1V2 (K)		1.180	1.200	1.220	Vdc	
Output Regulation Line: $V_{IN} = V_{IN, Min}$ to $V_{IN, Max}$  Load: $I_O = I_{O, Min}$ to $I_{O, Max}$  Temperature: $T_A = -40$ °C to +85°C	All	-	-	0.1	0.4	%Vo	
	All	-	-	0.1	0.4	%Vo	
	All	-	-	0.3	0.8	%Vo	
Ripple and Noise <sup>3</sup> Peak-to-Peak: (5Hz to 20MHz)	All	-	-	40	100	mVp-p	
Output Current	5V0 (A)	$I_O$	0	-	12	A	
	3V3 (F)		0	-	18		
	2V5 (G)		0	-	20		
	1V8 (Y)		0	-	25		
	1V5 (M)		0	-	25		
	1V2 (K)		0	-	25		
External Load Capacitance Capacitor ESR	All	-	-	-	10,000	μF	
			4	-	-	mΩ	
Output Current-limit Inception $V_{OUT} = 90\% V_{O, SET}$ (Autorecovery)	5V0 (A)	$I_O$	13.0	-	19	A	
	3V3 (F)		19.5	-	25		
	2V5 (G)		21.5	-	30		
	1V8 (Y)		26.5	-	34		
	1V5 (M)		26.5	-	34		
	1V2 (K)		26.5	-	34		
Over Voltage Range (Autorecovery)	5V0 (A)		5.9	6.2	6.9	V	
	3V3 (F)		3.9	4.1	4.9		
	2V5 (G)		3.0	3.2	3.9		
	1V8 (Y)		2.1	2.4	2.9		
	1V5 (M)		1.8	2.1	2.5		
	1V2 (K)		1.4	1.6	2.1		
Over Temperature Range (AVG. PCB TEMP) - Auto recovery	All		110	-	120	°C	
Efficiency $V_{IN} = V_{IN, NOM}$ $I_O = I_{O, MAX}$ $T_A = 25$ °C	5V0 (A)	$\eta$	90.0	91.0	94.0	%	
	3V3 (F)		$\eta$	89.0	90.0	93.0	%
	2V5 (G)		$\eta$	88.5	89.5	92.0	%
	1V8 (Y)		$\eta$	87.0	88.0	90.0	%
	1V5 (M)		$\eta$	83.5	84.5	88.0	%
	1V2 (K)		$\eta$	82.0	83.0	86.0	%



**Technical Reference Notes**  
**ALD12/18/20/25 Series**  
**(Single Output 16<sup>th</sup> Brick)**



**Electrical Specifications (continued)**

**OUTPUT SPECIFICATIONS (continued)**

Parameter	Device	Symbol	Min	Typ	Max	Unit
Turn-On Response Time <sup>4</sup> $V_{IN} = V_{IN-MIN}$ to $V_{IN-MAX}$	All	-	-	2	5	ms
Enable to Output Turn-ON Delay $V_{IN} = V_{IN-MIN}$ to $V_{IN-MAX}$ $I_O = I_{O-MIN}$ to $I_{O-MAX}$	All	-	-	-	10	ms
+ $V_{IN}$ to Output Turn-On Delay Enable Pin: Active $V_{IN} = V_{IN-MIN}$ to $V_{IN-MAX}$ $I_O = I_{O-MIN}$ to $I_{O-MAX}$	All	-	-	-	10	ms
Switching Frequency	All 2V5, 5V0	-	560 650	625 725	690 800	KHz
Dynamic Response: $\Delta I_O / \Delta t$ $C_O =$ use Figure 2 test setup Peak Deviation for Load Step Change from $I_O = 50\%$ to $75\%$ of $I_{O,MAX}$ :	All	-	-	0.1	-	A/ $\mu$ s
Settling Time to within 1% of output set point voltage – $V_{O,SET}$ :	All	-	-	3	6	% $V_O$
Peak Deviation for Load Step Change from $I_O = 50\%$ to $25\%$ of $I_{O,MAX}$ :	All	-	-	80	200	$\mu$ s
Settling Time to within 1% of output set point voltage – $V_{O,SET}$ :	All	-	-	3	6	% $V_O$
Output Overshoot at Turn-on Passive Resistive Full Load	$V_O \leq 1V8$ $V_O > 1V8$	- -	- -	0 0	5 4	% $V_O$
Output Enable ON/OFF Enable Signal Slew Rate	All	-	0.01	-	-	V/ms
Negative Enable ("N" suffix)	N suffix	-	-0.5	-	1.2	V
Enable Pin Voltage: Mod-ON Mod-OFF	- -	-	2.95	-	20	V
Positive Enable (No suffix)	No suffix	-	2.95	-	20	V
Enable Pin voltage: Mod-ON Mod-OFF	- -	-	-0.5	-	1.2	V
Output Voltage Remote Sensing	All	-	-	-	10	% $V_O$
Output Voltage Trim Range <sup>5</sup>	All	-	90	-	110	% $V_O$

- NOTES: 1. The converter is not internally fused; an external fuse must be used.  
 2. Refer to Figure 1 for the input reflected ripple test setup.  
 3. Refer to Figure 2 for the Output Ripple and Noise Test Measurement Setup.  
 4. Measure output rise time from 10%  $V_O$  to 90%  $V_O$ .  
 5. Refer to the output trim equations provided (Equations 1 and 2).

**Electrical Specifications** *(continued)*

**SAFETY AGENCY / MATERIAL RATING / ISOLATION**

Parameter	Device					
Safety Approval	All	UL/cUL 60950 TUV EN 60950				
Material Flammability Rating	All	UL94V-0				
Parameter	Device	Symbol	Min	Typical	Max	Unit
Input to Output Capacitance	All		-	1000	-	pF
Input to output Resistance	All		-	10	-	Mohms
Input to Output Insulation Type	All		-	Basic	-	-

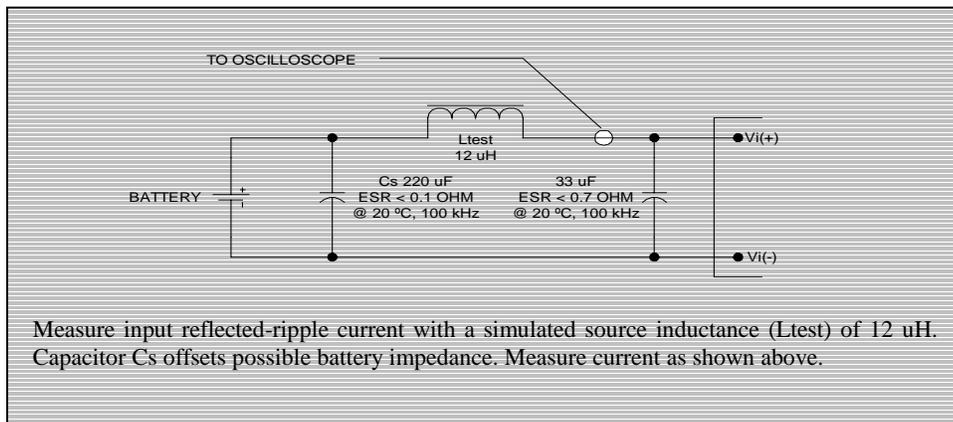

Figure 1. Input Reflected Ripple Current Measurement Setup.

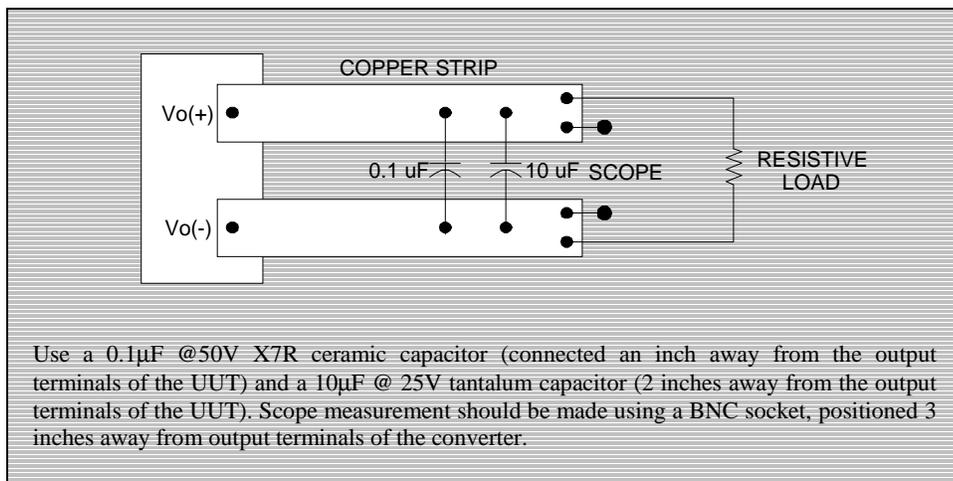

Figure 2. Peak to Peak Output Noise Measurement Setup.

## Basic Operation and Features

### INPUT UNDER VOLTAGE LOCKOUT

To prevent any instability to the converter, which may affect the end system, the converter have been designed to turn-on once  $V_{IN}$  is in the voltage range of 34-36 VDC. Likewise, it has also been programmed to turn-off when  $V_{IN}$  drops down to 31-33.5 VDC.

### OUTPUT VOLTAGE ADJUST/TRIM

The converter comes with a TRIM pin (PIN 6), which is used to adjust the output by as much as 90% to 110% of its set point. This is achieved by connecting an external resistor as described below.

To **INCREASE** the output, external  $R_{adj\_up}$  resistor should be connected between TRIM PIN (Pin6) and +SENSE PIN (Pin 7). Please refer to Equation (1) for the required external resistance and output adjust relationship.

#### Equation (1a): 1.5V to 5V

$$R_{adj\_up} = \left[ \frac{5.1 \times V_{o\_set} \times (100 + \Delta\%)}{1.225 \times \Delta\%} - \frac{510}{\Delta\%} - 10.2 \right] \text{ K}\Omega$$

#### Equation (1b): 1.2V

$$R_{adj\_up} = \left[ \frac{5.1 \times V_{o\_set} \times (100 + \Delta\%)}{0.6 \times \Delta\%} - \frac{510}{\Delta\%} - 10.2 \right] \text{ K}\Omega$$

To **DECREASE** the output, external  $R_{adj\_down}$  resistor should be connected between TRIM pin (Pin 6) and -SENSE PIN (Pin 5). Please refer to Equation (2) for the required external resistance and output adjust relationship.

#### Equation (2):

$$R_{adj\_down} = \left( \frac{510}{\Delta\%} - 10.2 \right) \cdot \text{k}\Omega$$

Where:  $\Delta\%$  = percent change in output voltage

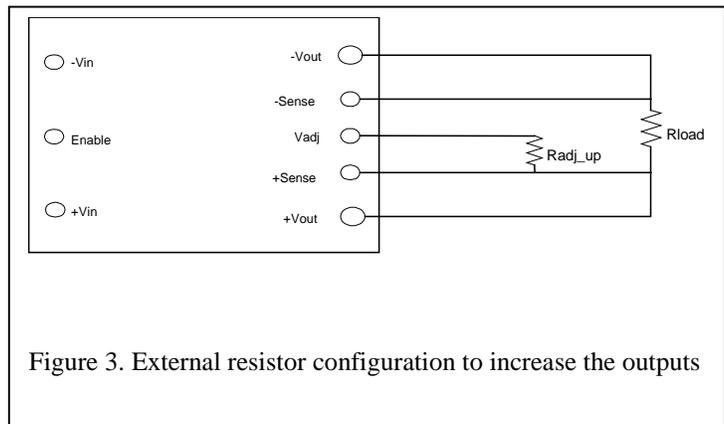

Figure 3. External resistor configuration to increase the outputs

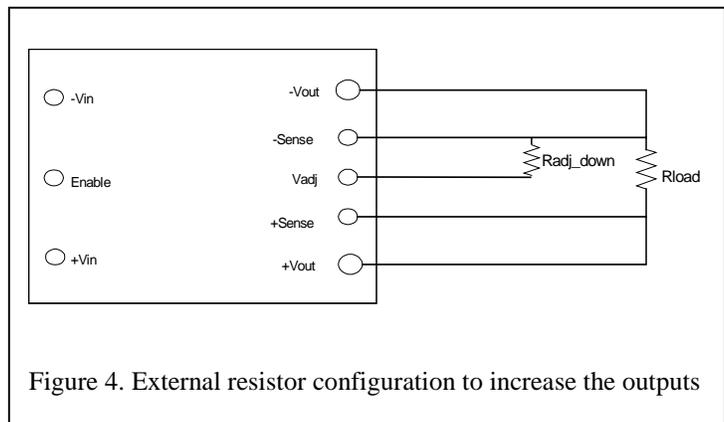

Figure 4. External resistor configuration to decrease the outputs

### OUTPUT ENABLE

The converter comes with an Enable pin (PIN 2), which is primarily used to turn ON/OFF the converter. Both a Positive (no “N” suffix required) and a Negative (suffix “N” required) Enable Logic options are being offered.

## **Basic Operation and Features** *(continued)*

### **OUTPUT ENABLE** *(continued)*

For Positive Enable, the converter is turned on when the Enable pin is at logic HIGH or left open. The unit turns off when the Enable pin is at logic LOW or directly connected to  $-V_{IN}$ . On the other hand, the Negative Enable version turns unit on when the Enable pin is at logic LOW or directly connected to  $-V_{IN}$ . The unit turns off when the Enable pin is at Logic HIGH.

### **OUTPUT OVER VOLTAGE PROTECTION (OVP)**

The Over Voltage Protection circuit is non-latching - auto recovery mode. The converter will shut down and attempt to restart until the fault is removed. There is a 20-50ms lockout period between restart attempts.

### **OVER CURRENT PROTECTION (OCP)**

The Over Current Protection is non-latching - auto recovery mode. The converter shuts down once the output current reaches the OCP range. The converter will attempt to restart until the fault is removed. There is a 20-50ms lockout period between restart attempts. Note that the OCP threshold will be reduced proportionally with the output voltage trim up and/or remote sense compensation. The percent rise in output voltage will be proportional to the reduction in OCP current inception.

### **OVER TEMPERATURE PROTECTION (OTP)**

The Over Temperature Protection circuit will shutdown the converter once the average PCB temperature (See Figure 43A for OTP reference sense point) reaches the OTP range. This feature prevents the unit from overheating and consequently going into thermal runaway, which may further damage the converter and the end system. Such overheating may be an effect of operation outside the given power thermal derating conditions. Restart is possible once the temperature of the sensed location drops to less than 110°C.

### **REMOTE SENSE**

The remote sense pins can be used to compensate for any voltage drops (per indicated max limits) that may occur along the connection between the output pins to the load. Pin 7 (+Sense) and Pin 5 (-Sense) should be connected to Pin 8 (+Vout) and Pin 4 (-Vout) respectively at the point where regulation is desired. The combination of remote sense and trim adjust cannot exceed 110% of  $V_O$ . When output voltage is trimmed up (through remote sensing and/or trim pin), output current must be derated and maximum output power must not be exceeded.

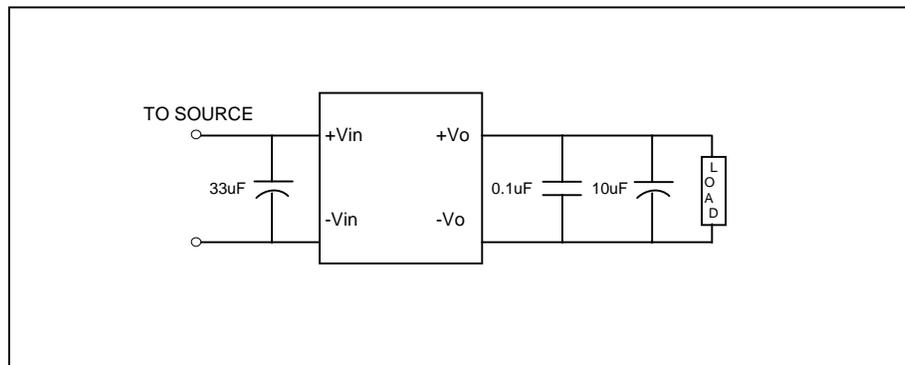
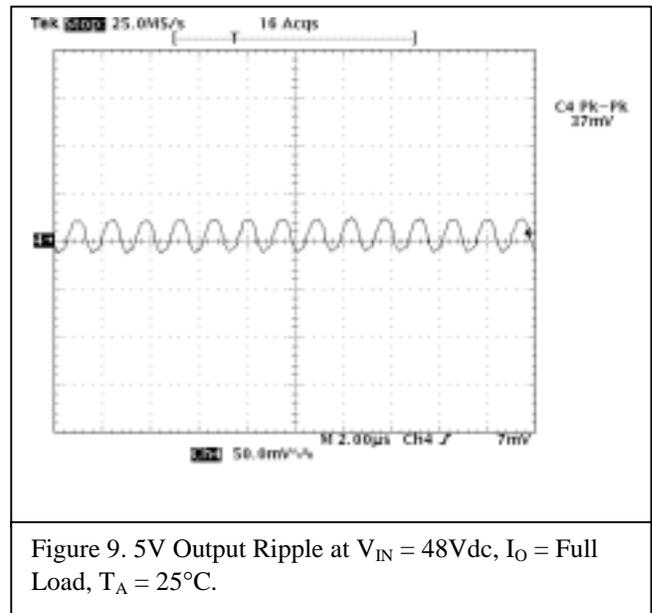
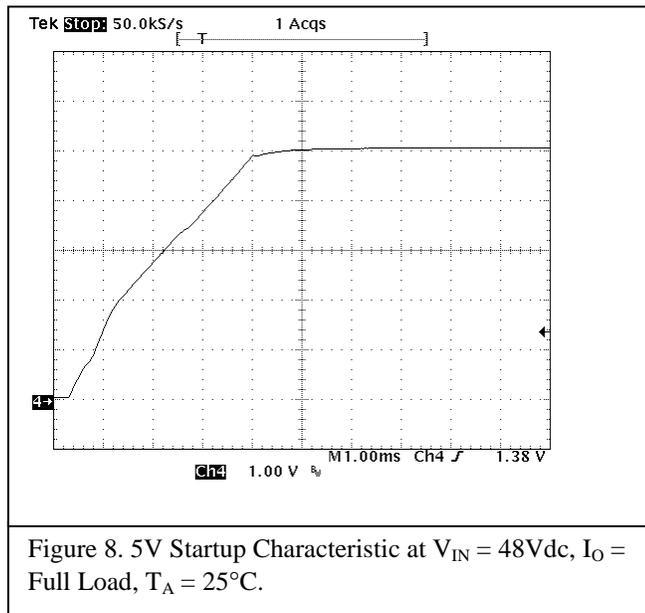
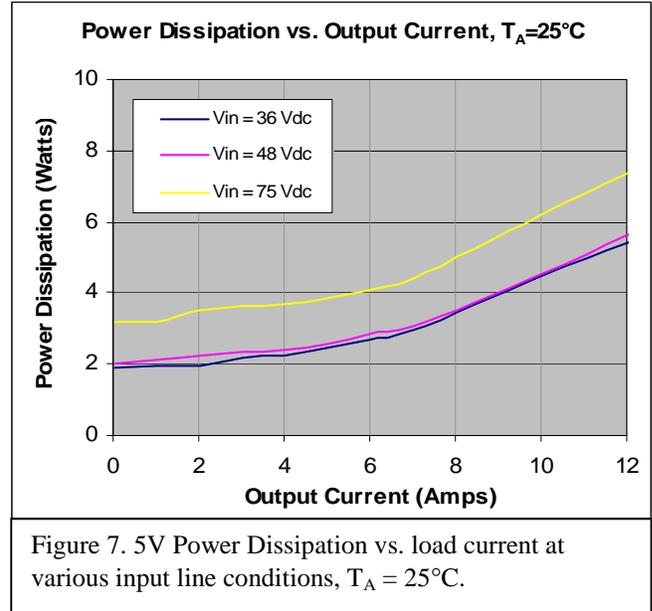
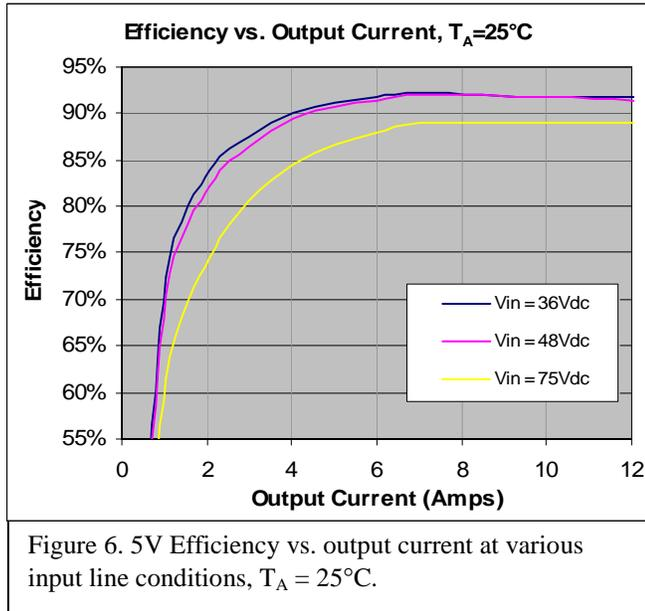

Figure 5. Typical Application Circuit

**Performance Curves**

5V Version



**Performance Curves**

5V Version (continued)

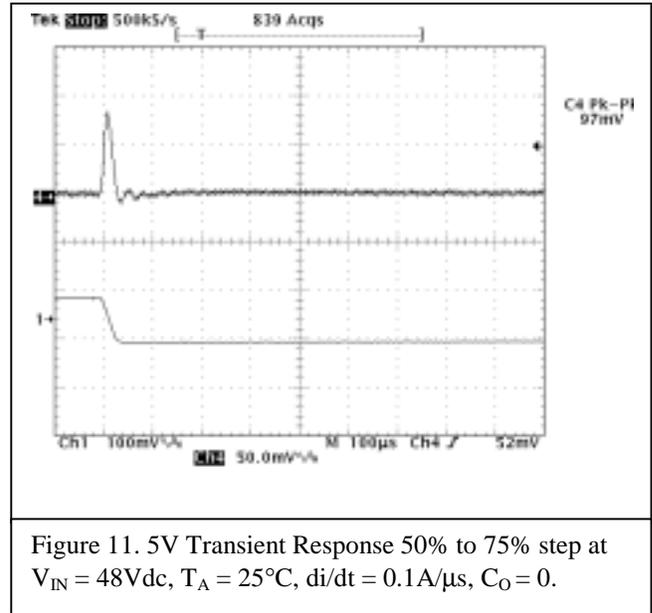
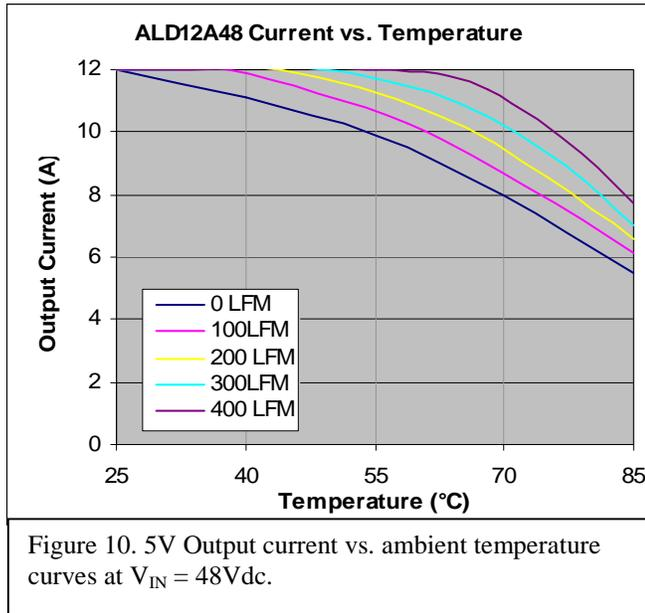

**3.3V Version**

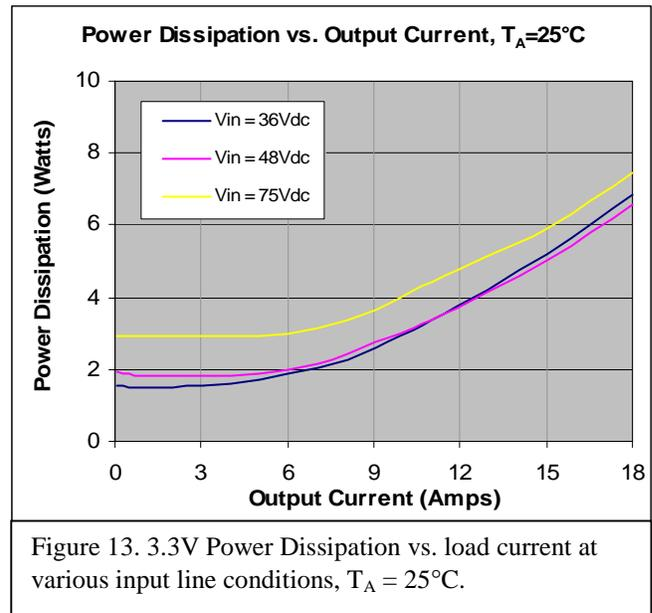
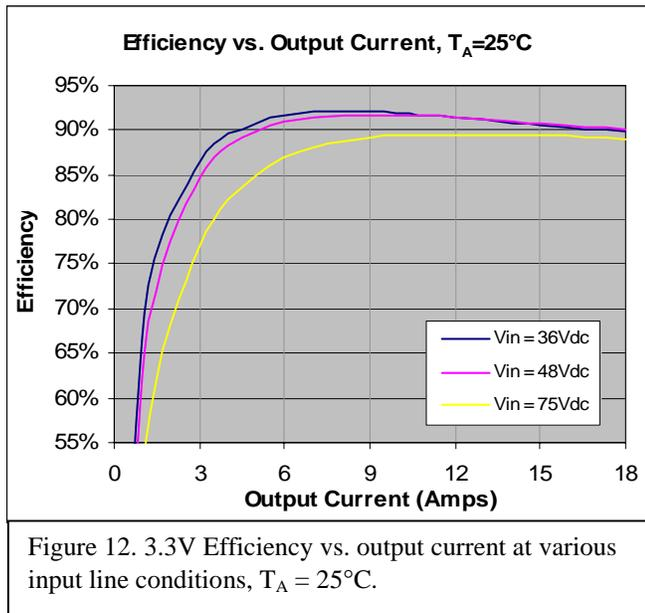

## Performance Curves

### 3.3V Version (continued)

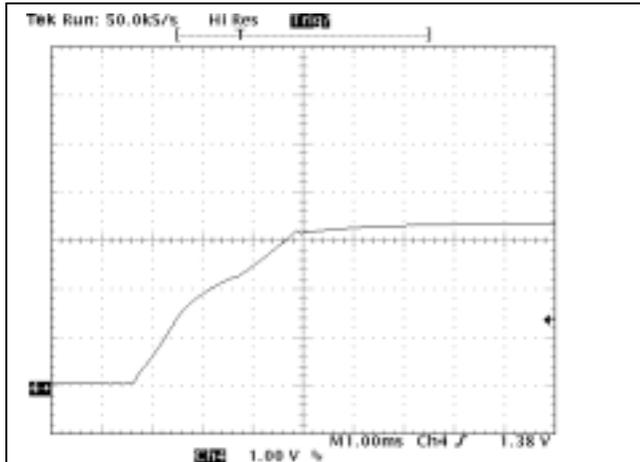

Figure 14. 3.3V Startup Characteristic at  $V_{IN} = 48Vdc$ ,  $I_O = \text{Full Load}$ ,  $T_A = 25^\circ C$ ,  $C_O = 0$ .

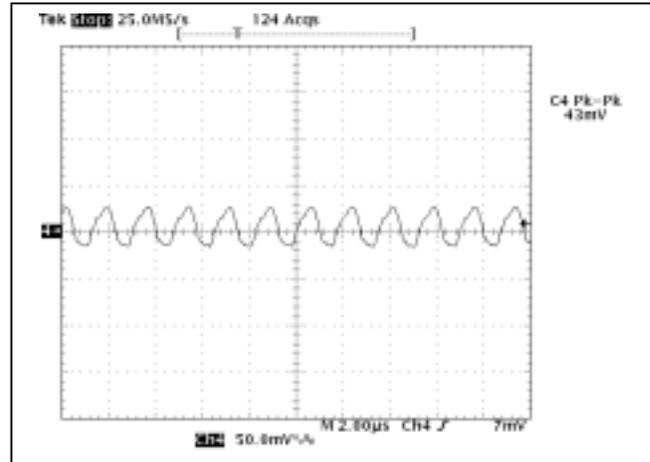

Figure 15. 3.3V Output Ripple at  $V_{IN} = 48Vdc$ ,  $I_O = \text{Full Load}$ ,  $T_A = 25^\circ C$ .

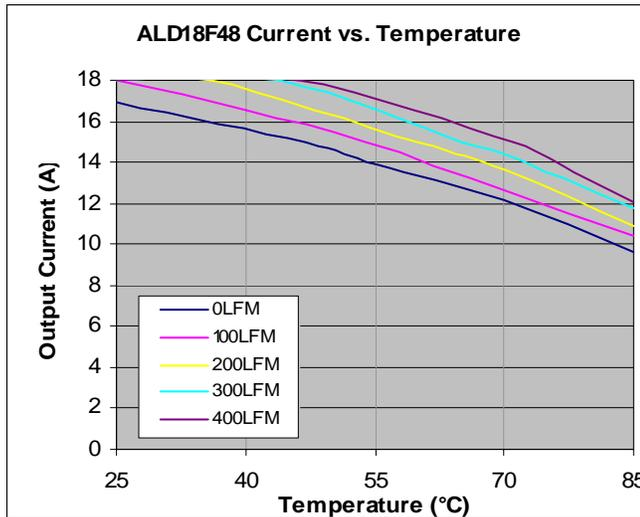

Figure 16. 3.3V Output current vs. ambient temperature curves at  $V_{IN} = 48Vdc$ .

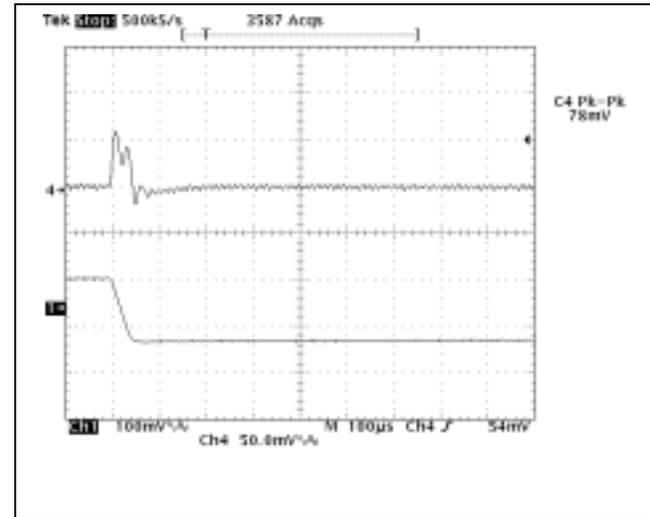
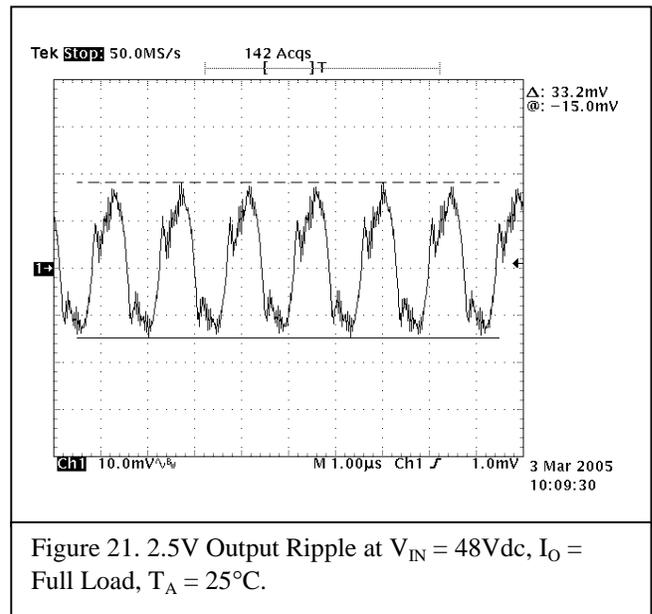
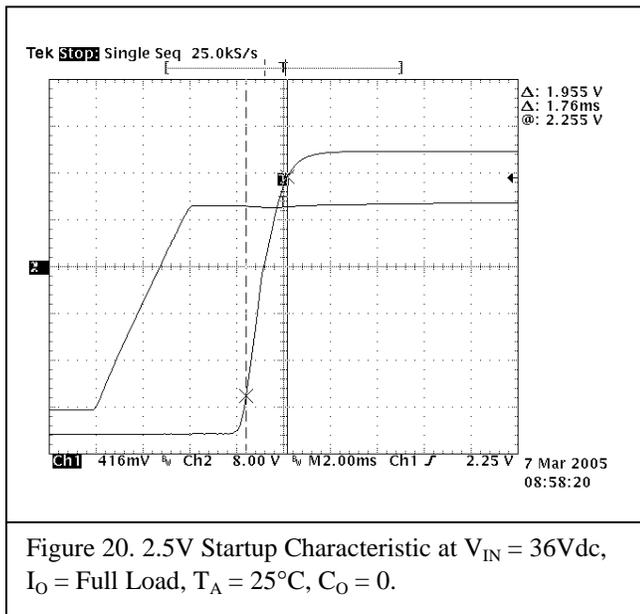
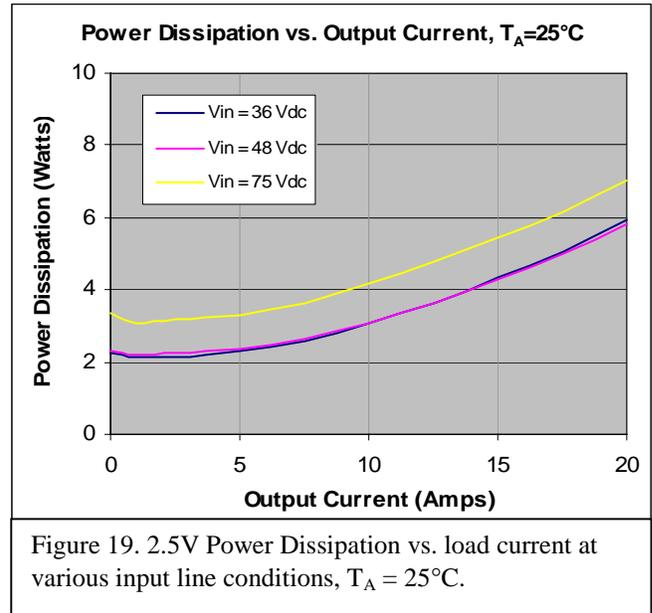
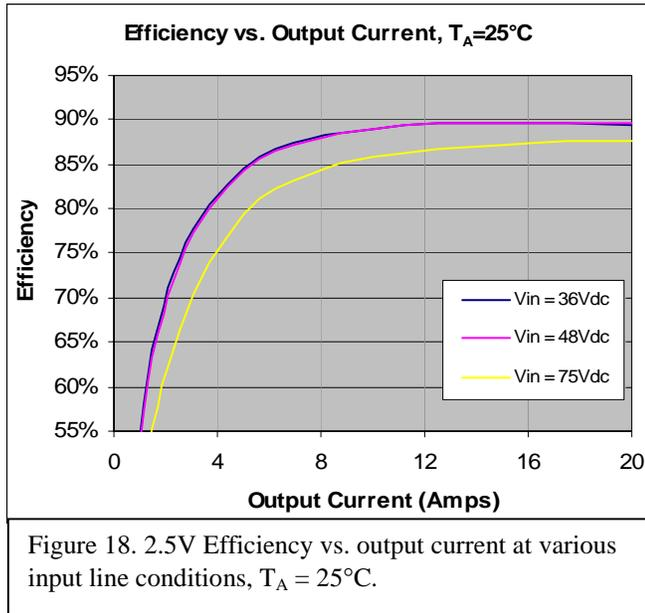

Figure 17. 3.3V Transient Response 50% to 75% step at  $V_{IN} = 48Vdc$ ,  $T_A = 25^\circ C$ ,  $di/dt = 0.1A/\mu s$ ,  $C_O = 0$ .

## Performance Curves

### 2.5V Version



**Performance Curves**

2.5V Version (continued)

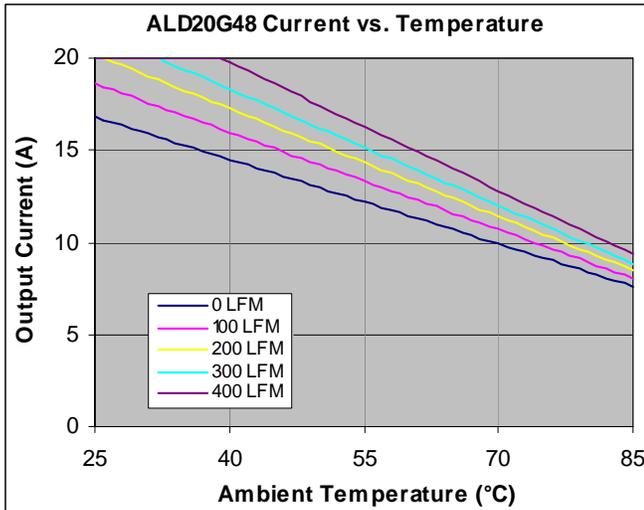

Figure 22. 2.5V Output current vs. ambient temperature curves at  $V_{IN} = 48Vdc$ .

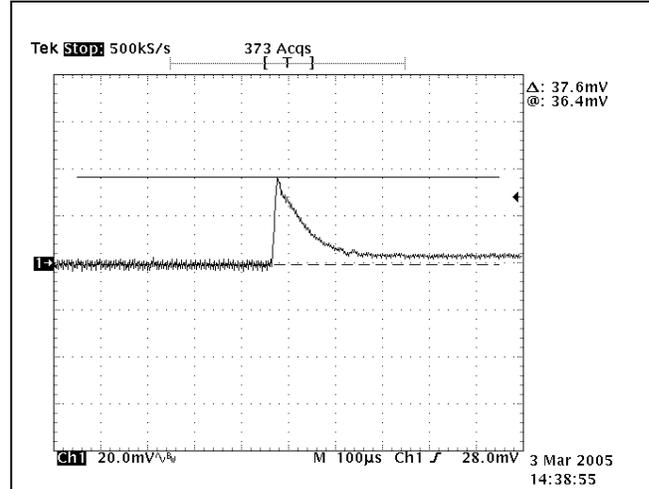

Figure 23. 2.5V Transient Response 50% to 75% step at  $V_{IN} = 48Vdc$ ,  $T_A = 25^\circ C$ ,  $di/dt = 0.1A/\mu s$ ,  $C_O = 0$ .

1.8V Version

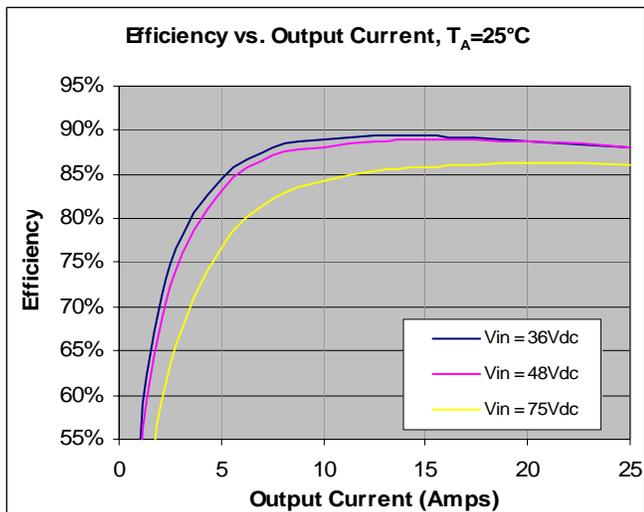

Figure 24. 1.8V Efficiency vs. output current at various input line conditions,  $T_A = 25^\circ C$ .

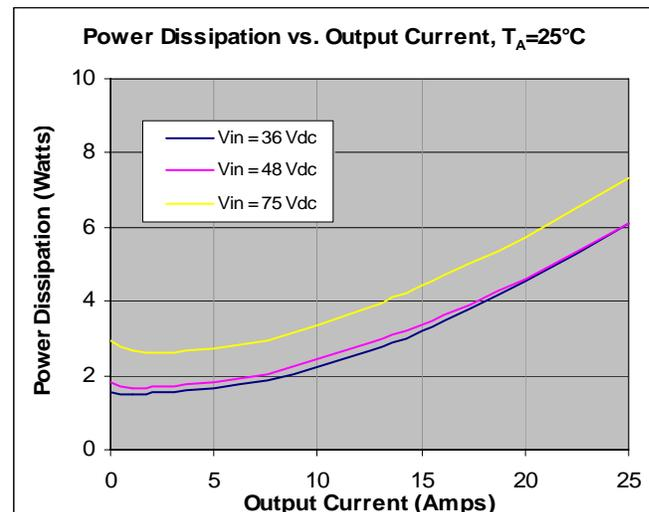

Figure 25. 1.8V Power Dissipation vs. load current at various input line conditions,  $T_A = 25^\circ C$ .

**Performance Curves**

**1.8V Version**

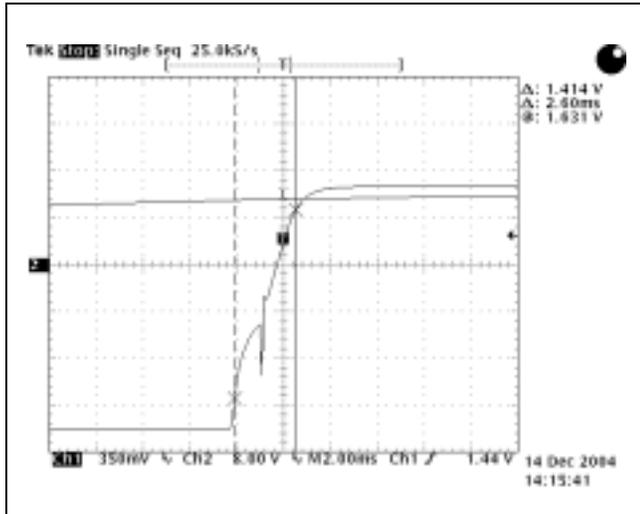

Figure 26. 1.8V Startup Characteristic at  $V_{IN} = 36Vdc$ ,  $I_O = \text{Full Load}$ ,  $T_A = 25^\circ C$ ,  $C_O = 0$ .

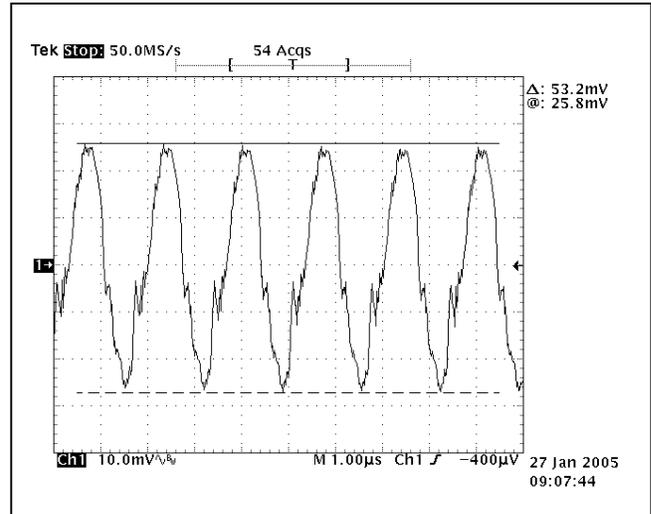

Figure 27. 1.8V Output Ripple at  $V_{IN} = 48Vdc$ ,  $I_O = \text{Full Load}$ ,  $T_A = 25^\circ C$ .

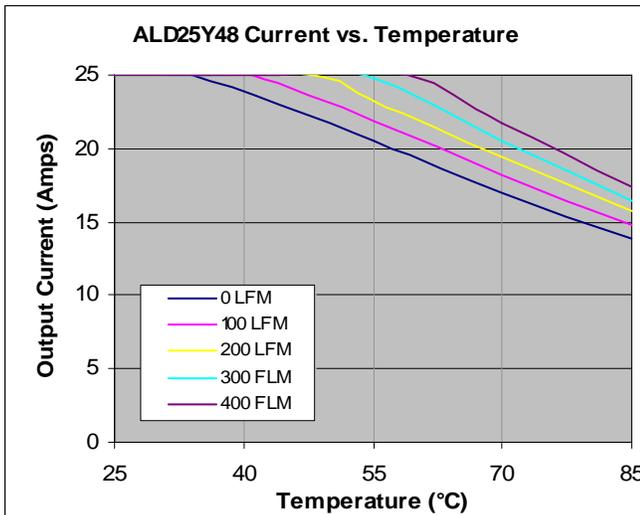

Figure 28. 1.8V Output current vs. ambient temperature curves at  $V_{IN} = 48Vdc$ .

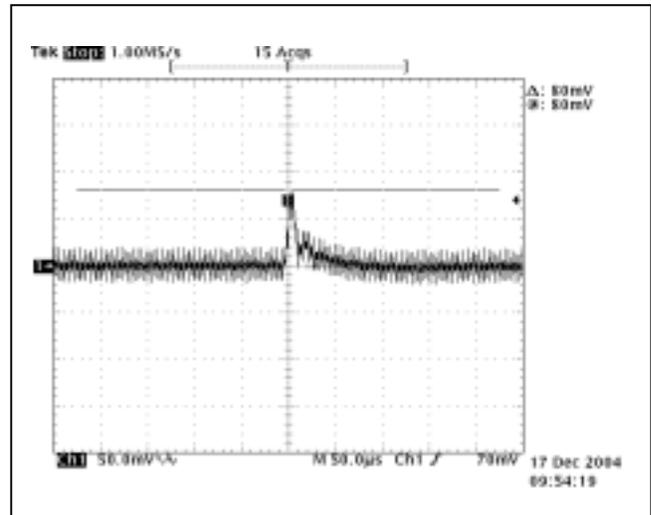

Figure 29. 1.8V Transient Response 50% to 75% step at  $V_{IN} = 48Vdc$ ,  $T_A = 25^\circ C$ ,  $di/dt = 0.1A/\mu s$ ,  $C_O = 0$ .

**Performance Curves**

**1.5V Version**

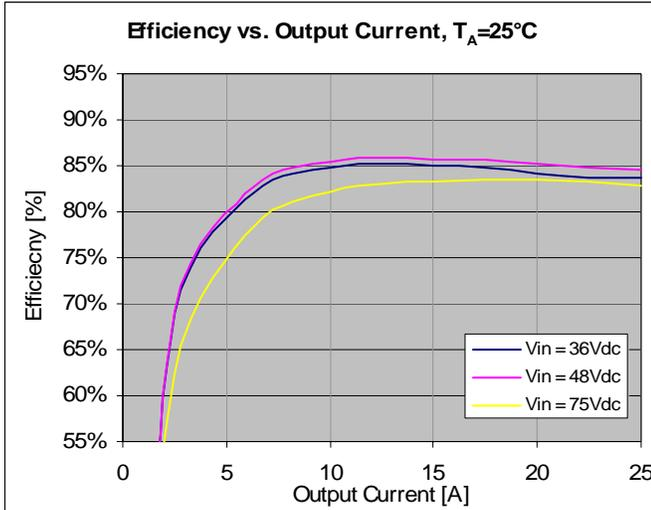

Figure 30. 1.5V Efficiency vs. output current at various input line conditions,  $T_A = 25^\circ\text{C}$ .

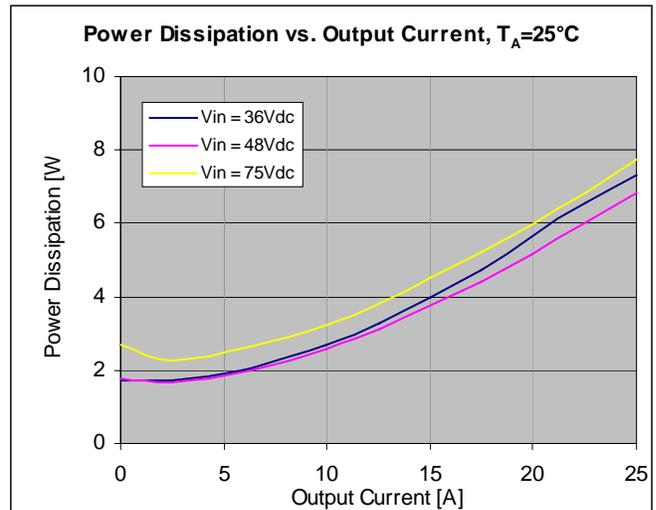

Figure 31. 1.5V Power dissipation vs. output current at various input line conditions,  $T_A = 25^\circ\text{C}$ .

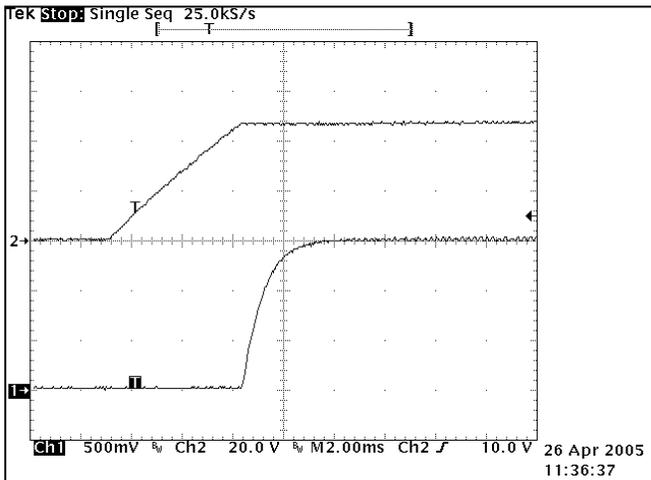

Figure 32. 1.5V Startup Characteristic at  $V_{IN} = 48\text{V}$ ,  $T_A = 25^\circ\text{C}$ .

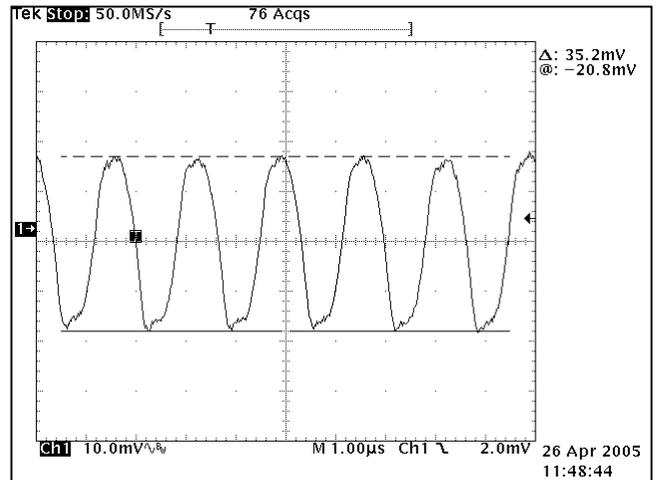

Figure 33. 1.5V Output Ripple at  $V_{IN} = 48\text{Vdc}$ ,  $I_O = \text{Full Load}$ ,  $T_A = 25^\circ\text{C}$ .

## Performance Curves

### 1.5V Version (continued)

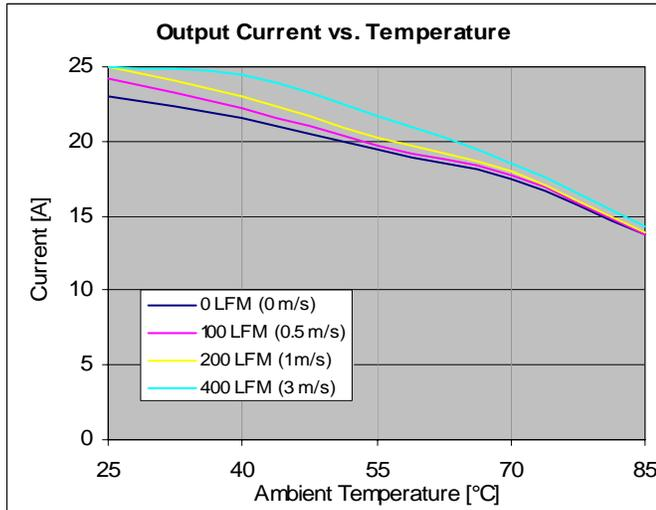

Figure 34. 1.5V Output current vs. ambient temperature curves at  $V_{IN} = 48Vdc$ .

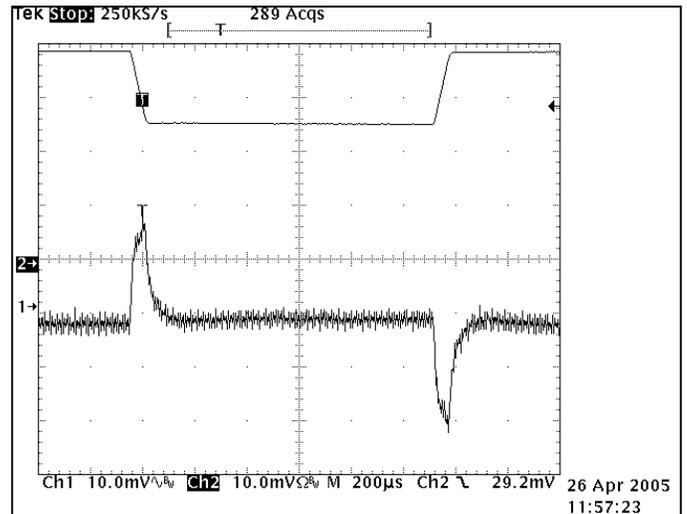

Figure 35. 1.5V Output Transient Response 50% to 75% step at  $V_{IN} = 48Vdc$ ,  $T_A = 25^\circ C$ ,  $di/dt = 0.1A/\mu s$ ,  $C_O = 0$ .

### 1.2V Version

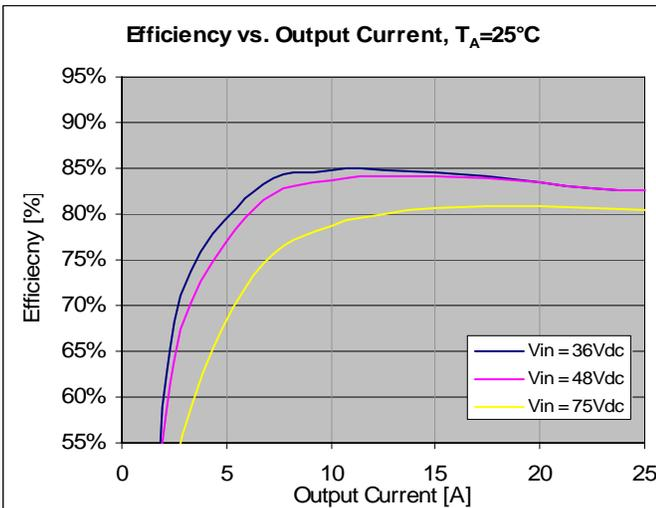

Figure 36. 1.2V Efficiency vs. output current at various input line voltage,  $T_A = 25^\circ C$ .

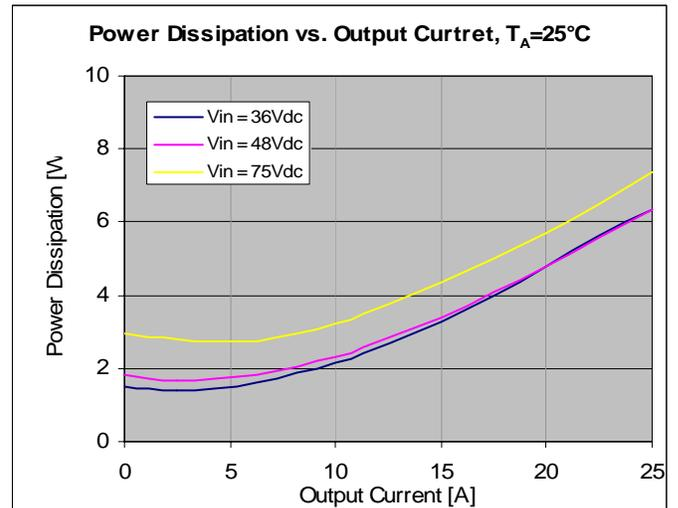

Figure 37. 1.2V Power dissipation vs. output current at various input line conditions,  $T_A = 25^\circ C$ .

**Performance Curves**

1.2V Version (continued)

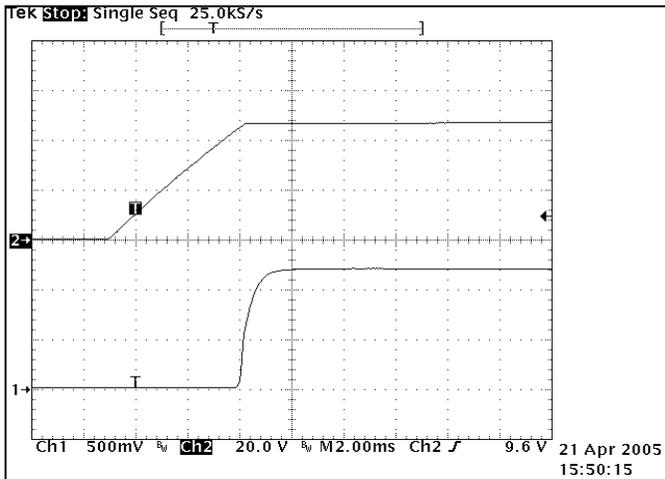

Figure 38. 1.2V Startup Characteristic at  $V_{IN} = 48V$ ,  $T_A = 25^\circ C$ .

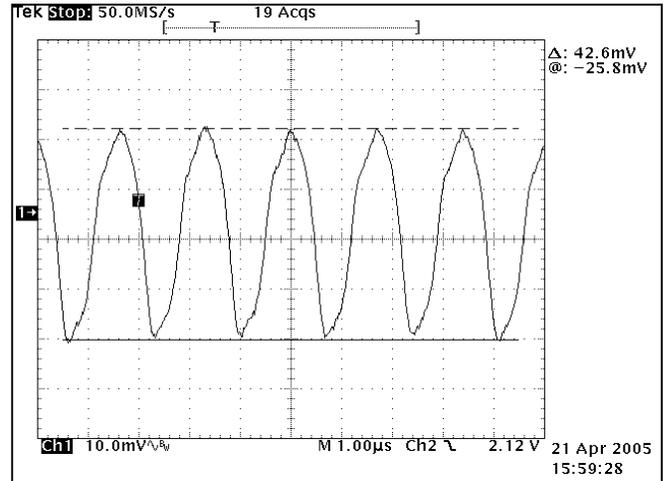

Figure 39. 1.2V Output Ripple at  $V_{IN} = 48Vdc$ ,  $I_O = Full$  Load,  $T_A = 25^\circ C$ .

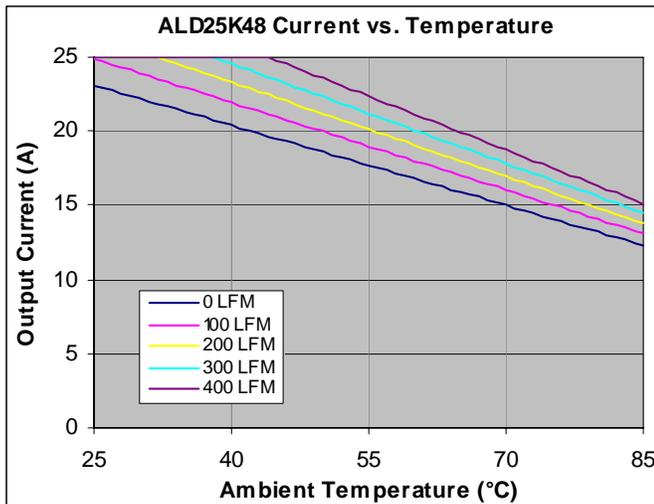

Figure 40. 1.2V Output current vs. ambient temperature  $V_{IN} = 48V$ ,  $T_A = 25^\circ C$ .

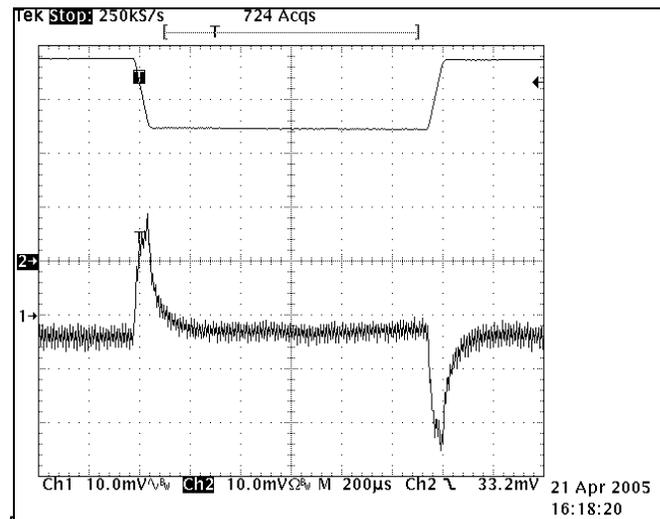

Figure 41. 1.2V Output Transient Response 50% to 75% step at  $V_{IN} = 48Vdc$ ,  $T_A = 25^\circ C$ ,  $di/dt = 0.1A/\mu s$ ,  $C_O = 0$ .

**Input Filter for FCC Class B Conducted Noise**

A reference design for an input filter that can provide FCC Class B conducted noise levels is shown below (See Figure 42). Two common mode connected inductors are used in the circuit along with balanced bypass capacitors to shunt common mode currents into the ground plane. Shunting noise current back to the converter reduces the amount of energy reaching the input LISN for measurement.

The application circuit shown has an earth ground (frame ground) connected to the converter output (-) terminal. Such a configuration is common practice to accommodate safety agency requirements. Grounding an output terminal results in much higher conducted emissions as measured at the input LISN because a hard path for common mode current back to the LISN is created by the frame ground. “Floating” loads generally result in much lower measured emissions. The electrical equivalent of a floating load, for EMI measurement purposes, can be created by grounding the converter output (load) through a suitably sized inductor(s) while maintaining the necessary safety bonding.

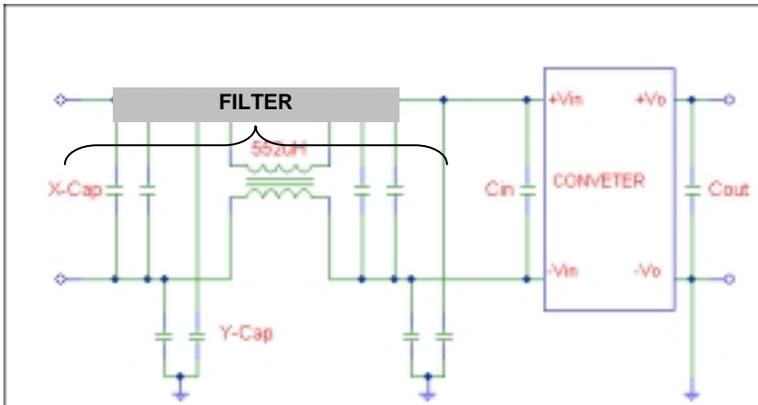

Figure 42: Class B Filter Circuit

**PARTS LIST**

CKT CODE	DESCRIPTION
Common Mode Choke	CTX01-15091 Cooper Electronic Technologies
X-Cap	0.47 $\mu$ F X 4pcs
Y-Cap	22 nF X 4 pcs
Cin	33 uF

**Mechanical Specifications**

Parameter	Device	Symbol	Min	Typ	Max	Unit
Dimension	All	L	1.28 [32.5]	1.30 [33.0]	1.32 [33.5]	in [ mm ]
		W	0.88 [22.35]	0.90 [22.9]	0.92 [23.36]	in [ mm ]
		H	0.33 [8.38]	0.35 [8.8]	0.37 [9.39]	in [ mm ]
Weight	All		-	14.17 [0.54]	-	g [oz]
PIN ASSIGNMENT						
1		+V <sub>IN</sub>		5		-SENSE
2		ENABLE		6		TRIM
3		-V <sub>IN</sub>		7		+SENSE
4		-V <sub>OUT</sub>		8		+V <sub>OUT</sub>

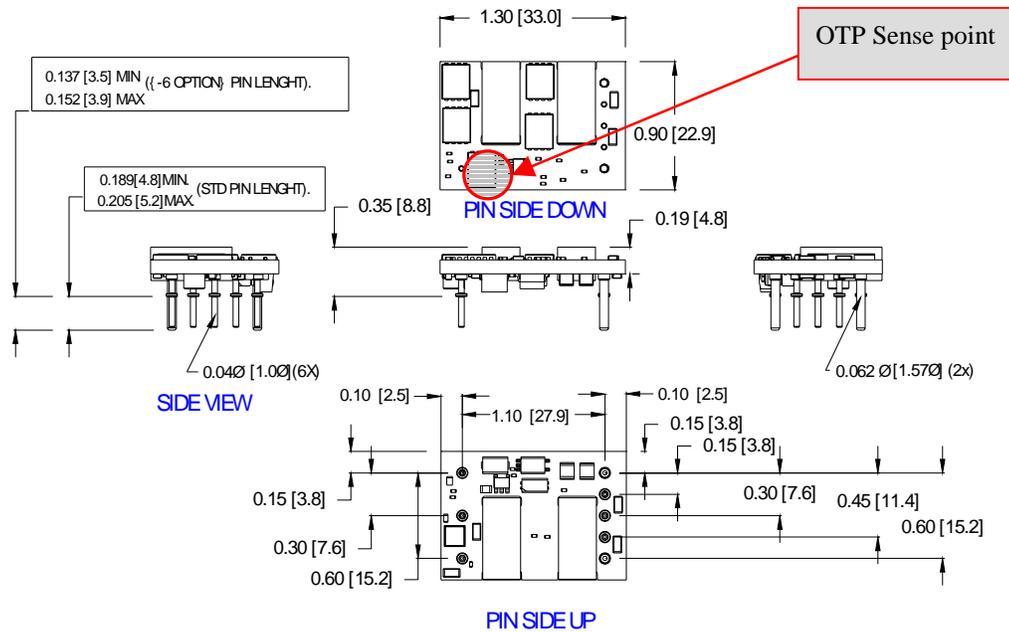

Figure 43A. Mechanical Outline – Through hole termination

**Mechanical Specifications** *(continued)*

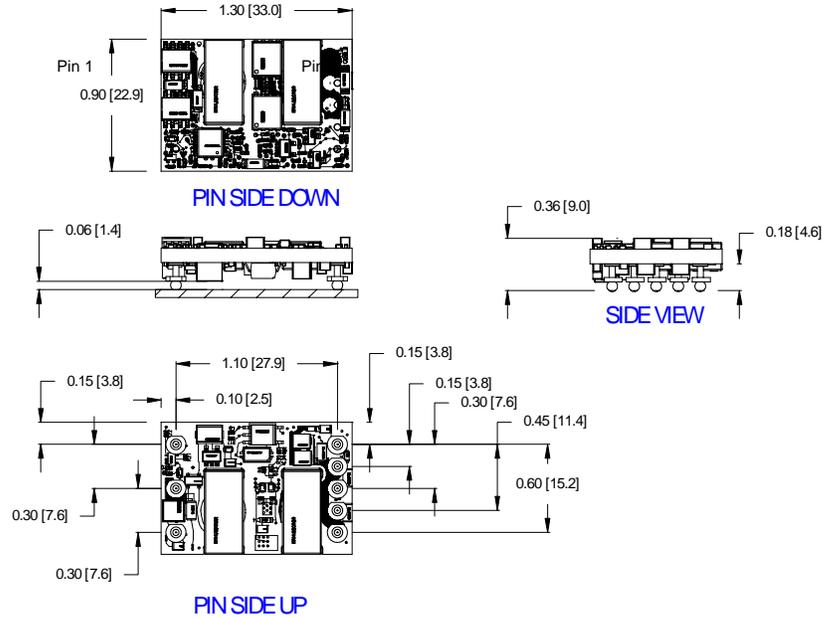

Figure 43B. Mechanical Outline – SMT (Solder Ball) Termination.

**SOLDERING CONSIDERATIONS**

The through hole terminated converters are compatible with standard wave soldering techniques. When wave soldering, the converter pins should be preheated for 20-30 sec at 110°C and wave soldered at 260°C for less than 10 sec.

When hand soldering, the iron temperature should be maintained at 425°C and applied to the converter pins for less than 5 seconds. Longer exposure can cause internal damage to the converter. Cleaning can be performed with cleaning solvent IPA or with water.

For SMT terminated modules, refer to Figure 44 for the recommended reflow profile.

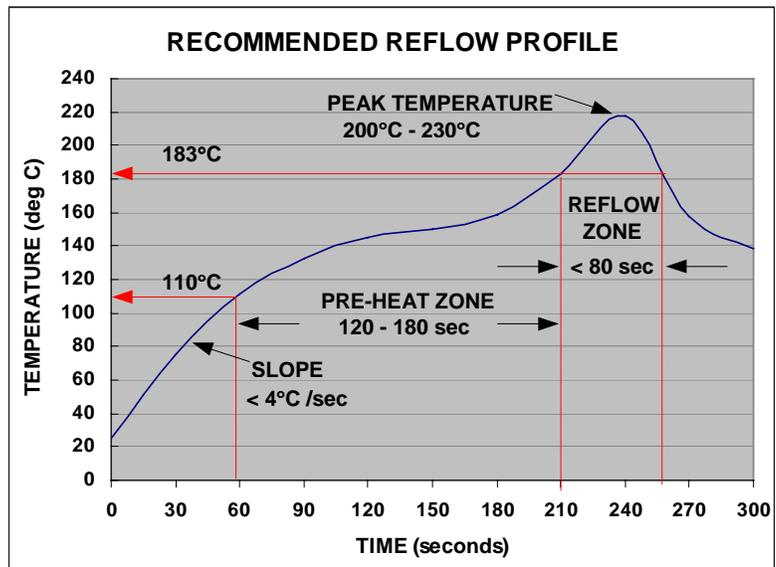

Figure 44. Recommended reflow profile for SMT modules.



**Technical Reference Notes**  
**ALD12/18/20/25 Series**  
**(Single Output 16<sup>th</sup> Brick)**



**PART NUMBERING SCHEME**

<b>A</b>	<b>CONSTRUCTION</b>	<b>D</b>	<b>O/P CURRENT</b>	<b>O/P VOLTAGE</b>	<b>Vin</b>	<b>Enable</b>	<b>-</b>	<b>TH PIN LENGTH</b>	<b>TERMINATION</b>
<b>A</b>	<b>W</b>	<b>D</b>	<b>xx</b>	<b>y</b>	<b>48</b>	<b>N</b>	<b>-</b>	<b>6</b>	<b>S</b>
	L = Open frame E = Baseplate		12 = 12A 18 = 18A 20 = 20A 25 = 25A 25 = 25A 25 = 25A	A = 5.0V F = 3.3V G = 2.5V Y = 1.8V M = 1.5V K = 1.2V		N = Negative Blank = Positive		6 = 3.7mm Blank = 5mm default	S = SMT Termination (Consult with Factory) Blank = (TH) thru-hole

- Note: 1) For Through Hole termination: - Std pin length is 5mm nominal (min: 0.189 [4.8]; max: 0.205 [5.2] / in [mm])  
 - "-6" option is 3.7mm nominal (min: 0.137 [3.5]; max: 0.152 [3.9] / in [mm])  
 - Pins 4&8 diameter:  $\varnothing = 0.062$  [1.57], others:  $\varnothing = 0.04$  [1.0] (6X)  
 2) For SMT termination: - Recommended surface mount pad  $\varnothing = 0.11$  [2.79]  $\pm$  0.005 [0.13] (in [mm])

Please call 1-888-41-ASTEC for further inquiries or visit us at [www.astecpower.com](http://www.astecpower.com)