

LM4871 Boomer® Audio Power Amplifier Series

1.1W Audio Power Amplifier with Shutdown Mode

General Description

The LM4871 is a bridge-connected audio power amplifier capable of delivering typically 1.1W of continuous average power to an 8Ω load with 0.5% (THD) from a 5V power supply.

Boomer audio power amplifiers were designed specifically to provide high quality output power with a minimal amount of external components. Since the LM4871 does not require output coupling capacitors, bootstrap capacitors, or snubber networks, it is optionally suited for low-power portable systems.

The LM4871 features an externally controlled, low-power consumption shutdown mode, as well as an internal thermal shutdown protection mechanism.

The unity-gain stable LM4871 can be configured by external gain-setting resistors.

Key Specifications

- THD at 1 kHz at 1W continuous average output power into 8Ω 0.5% (max)
- Output power at 10% THD+N at 1 kHz into 8Ω 1.5W (typ)
- Shutdown Current 0.6 μA (typ)

Features

- No output coupling capacitors, bootstrap capacitors, or snubber circuits are necessary
- Small Outline or DIP packaging
- Unity-gain stable
- External gain configuration capability
- Pin compatible with LM4861

Applications

- Portable Computers
- Desktop Computers
- Low Voltage Audio Systems

Typical Application

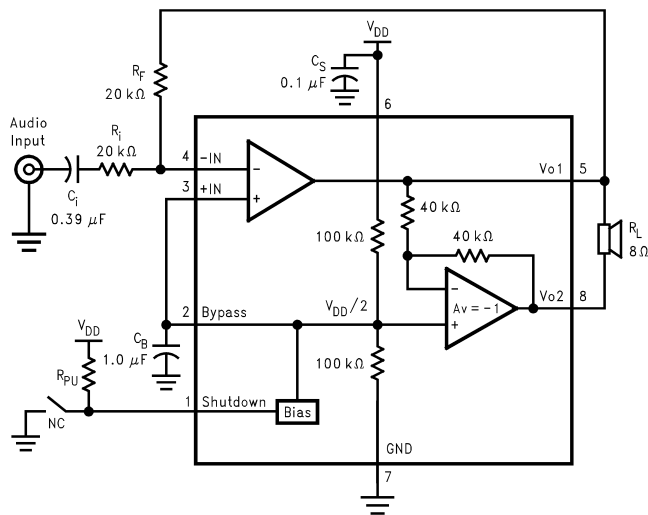

DS100008-1

FIGURE 1. Typical Audio Amplifier Application Circuit

Connection Diagram

Small Outline and DIP Package

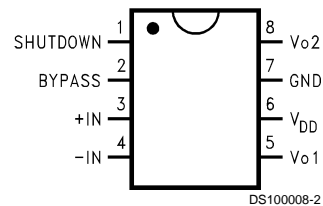

Top View

Order Number LM4871M or LM4871N
See NS Package Number M08A or N08E

Absolute Maximum Ratings (Note 2)

If Military/Aerospace specified devices are required, please contact the National Semiconductor Sales Office/Distributors for availability and specifications.

Supply Voltage	6.0V
Supply Temperature	-65°C to +150°C
Input Voltage	-0.3V to V_{DD} to +0.3V
Power Dissipation (Note 3)	Internally Limited
ESD Susceptibility (Note 4)	5000V
ESD Susceptibility (Note 5)	250V
Junction Temperature	150°C
Soldering Information	
Small Outline Package	
Vapor Phase (60 sec.)	215°C

Infrared (15 sec.)

220°C

See AN-450 "Surface Mounting and their Effects on Product Reliability" for other methods of soldering surface mount devices.

θ_{JC} (typ) — M08A	35°C/W
θ_{JA} (typ) — M08A	140°C/W
θ_{JC} (typ) — N08E	37°C/W
θ_{JA} (typ) — N08E	107°C/W

Operating Ratings

Temperature Range

$$T_{MIN} \leq T_A \leq T_{MAX}$$

$$-40^\circ\text{C} \leq T_A \leq 85^\circ\text{C}$$

Supply Voltage

$$2.0\text{V} \leq V_{DD} \leq 5.5\text{V}$$

Electrical Characteristics (Notes 1, 2)

The following specifications apply for $V_{DD} = 5\text{V}$ unless otherwise specified. Limits apply for $T_A = 25^\circ\text{C}$.

Symbol	Parameter	Conditions	LM4871		Units (Limits)
			Typical	Limit	
			(Note 6)	(Note 7)	
V_{DD}	Supply Voltage			2.0 5.5	V (min) V (max)
I_{DD}	Quiescent Power Supply Current	$V_{IN} = 0\text{V}$, $I_O = 0\text{A}$	6.5	10.0	mA (max)
I_{SD}	Shutdown Current	$V_{PIN1} = V_{DD}$	0.6	2	μA (max)
V_{OS}	Output Offset Voltage	$V_{IN} = 0\text{V}$	5	50	mV (max)
P_O	Output Power	THD = 0.5% (max); $f = 1\text{ kHz}$ THD+N = 10%; $f = 1\text{ kHz}$	1.10 1.5	1.0	W (min) W
THD+N	Total Harmonic Distortion+Noise	$P_O = 1\text{ Wrms}$; $A_{VD} = 2$; $20\text{ Hz} \leq f \leq 20\text{ kHz}$	0.25		%
PSRR	Power Supply Rejection Ratio	$V_{DD} = 4.9\text{V}$ to 5.1V	65		dB

Note 1: All voltages are measured with respect to the ground pin, unless otherwise specified.

Note 2: *Absolute Maximum Ratings* indicate limits beyond which damage to the device may occur. *Operating Ratings* indicate conditions for which the device is functional, but do not guarantee specific performance limits. *Electrical Characteristics* state DC and AC electrical specifications under particular test conditions which guarantee specific performance limits. This assumes that the device is within the Operating Ratings. Specifications are not guaranteed for parameters where no limit is given, however, the typical value is a good indication of device performance.

Note 3: The maximum power dissipation must be derated at elevated temperatures and is dictated by T_{JMAX} , θ_{JA} , and the ambient temperature T_A . The maximum allowable power dissipation is $P_{DMAX} = (T_{JMAX} - T_A) / \theta_{JA}$ or the number given in Absolute Maximum Ratings, whichever is lower. For the LM4871, $T_{JMAX} = 150^\circ\text{C}$. The typical junction-to-ambient thermal resistance is 140°C/W for package number M08A and is 107°C/W for package number N08E.

Note 4: Human body model, 100 pF discharged through a 1.5 k Ω resistor.

Note 5: Machine Model, 220 pF–240 pF discharged through all pins.

Note 6: Typicals are measured at 25°C and represent the parametric norm.

Note 7: Limits are guaranteed to National's AOQL (Average Outgoing Quality Level).

External Components Description (Figure 1)

Components		Functional Description
1.	R_i	Inverting input resistance which sets the closed-loop gain in conjunction with R_f . This resistor also forms a high pass filter with C_i at $f_c = 1/(2\pi R_i C_i)$.
2.	C_i	Input coupling capacitor which blocks the DC voltage at the amplifiers input terminals. Also creates a highpass filter with R_i at $f_c = 1/(2\pi R_i C_i)$. Refer to the section, Proper Selection of External Components , for an explanation of how to determine the value of C_i .
3.	R_f	Feedback resistance which sets the closed-loop gain in conjunction with R_i .
4.	C_S	Supply bypass capacitor which provides power supply filtering. Refer to the Power Supply Bypassing section for information concerning proper placement and selection of the supply bypass capacitor.
5.	C_B	Bypass pin capacitor which provides half-supply filtering. Refer to the section, Proper Selection of External Components , for information concerning proper placement and selection of C_B .

Typical Performance Characteristics

THD+N vs Frequency

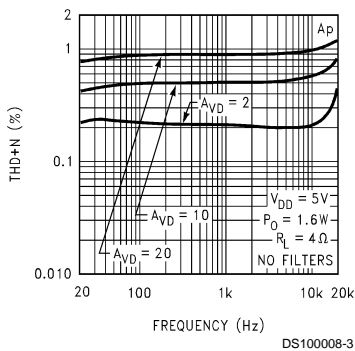

THD+N vs Frequency

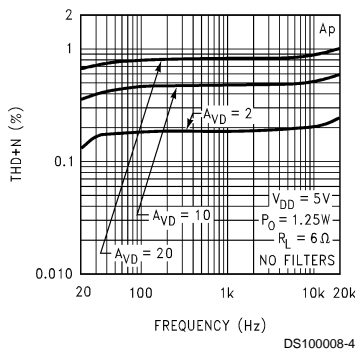

THD+N vs Frequency

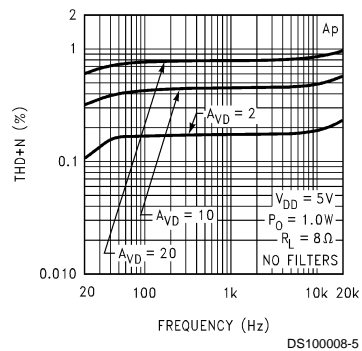

THD+N vs Output Power

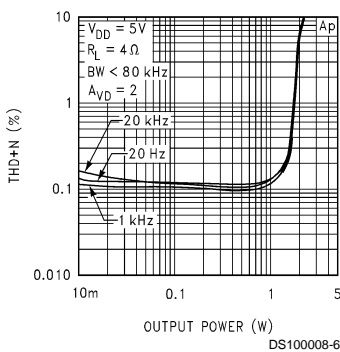

THD+N vs Output Power

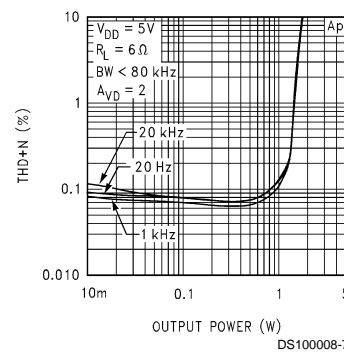

THD+N vs Output Power

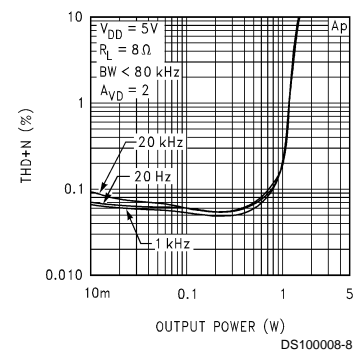

Output Power vs Supply Voltage

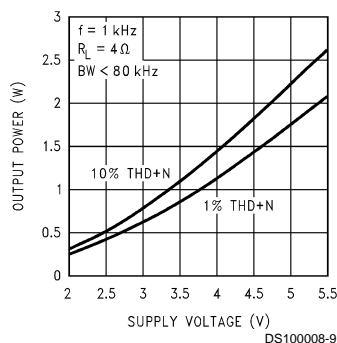

Output Power vs Supply Voltage

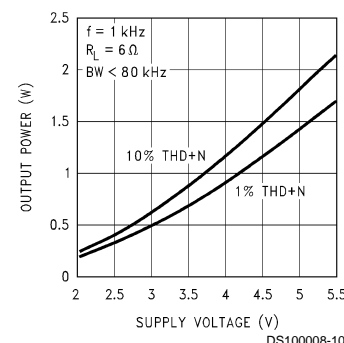

Output Power vs Supply Voltage

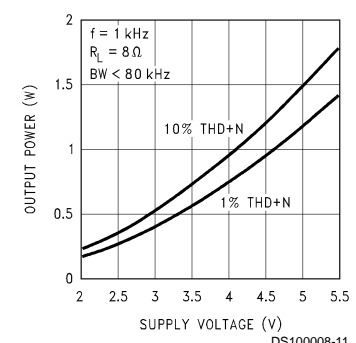

Typical Performance Characteristics (Continued)

Output Power vs Load Resistance

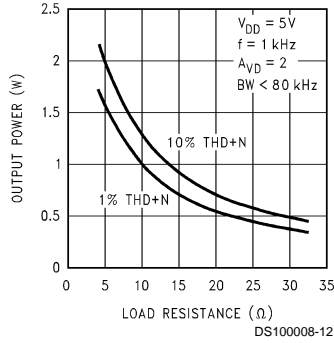

Power Dissipation vs Output Power

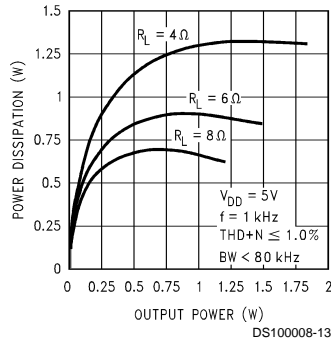

Power Derating Curve

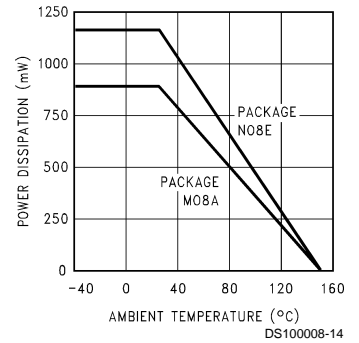

Clipping Voltage vs Supply Voltage

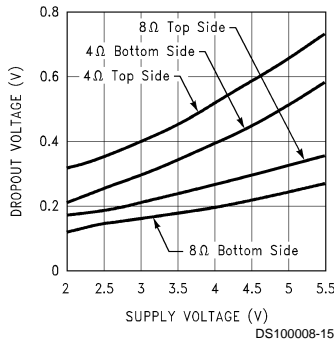

Noise Floor

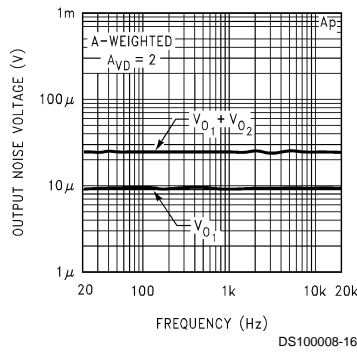

Frequency Response vs Input Capacitor Size

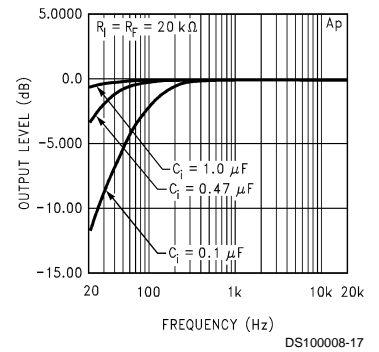

Power Supply Rejection Ratio

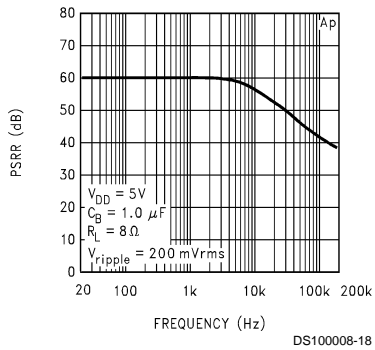

Open Loop Frequency Response

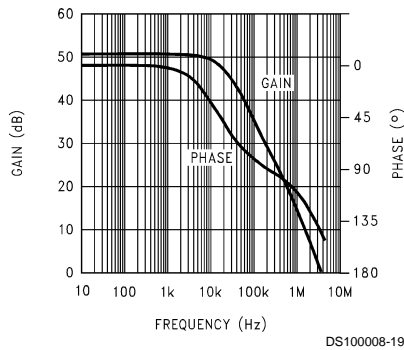

Supply Current vs Supply Voltage

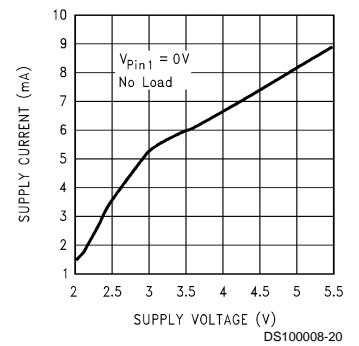

Application Information

BRIDGE CONFIGURATION EXPLANATION

As shown in *Figure 1*, the LM4871 has two operational amplifiers internally, allowing for a few different amplifier configurations. The first amplifier's gain is externally configurable, while the second amplifier is internally fixed in a unity-gain, inverting configuration. The closed-loop gain of the first amplifier is set by selecting the ratio of R_f to R_i while the second amplifier's gain is fixed by the two internal 40 k Ω resistors. *Figure 1* shows that the output of amplifier one serves as the input to amplifier two which results in both amplifiers producing signals identical in magnitude, but out of phase 180°. Consequently, the differential gain for the IC is

$$A_{VD} = 2 * (R_f/R_i)$$

By driving the load differentially through outputs Vo1 and Vo2, an amplifier configuration commonly referred to as "bridged mode" is established. Bridged mode operation is different from the classical single-ended amplifier configuration where one side of its load is connected to ground.

A bridge amplifier design has a few distinct advantages over the single-ended configuration, as it provides differential drive to the load, thus doubling output swing for a specified supply voltage. Four times the output power is possible as compared to a single-ended amplifier under the same conditions. This increase in attainable output power assumes that the amplifier is not current limited or clipped. In order to choose an amplifier's closed-loop gain without causing excessive clipping, please refer to the **Audio Power Amplifier Design** section.

A bridge configuration, such as the one used in LM4871, also creates a second advantage over single-ended amplifiers. Since the differential outputs, Vo1 and Vo2, are biased at half-supply, no net DC voltage exists across the load. This eliminates the need for an output coupling capacitor which is required in a single supply, single-ended amplifier configuration. Without an output coupling capacitor, the half-supply bias across the load would result in both increased internal IC power dissipation and also possible loudspeaker damage.

POWER DISSIPATION

Power dissipation is a major concern when designing a successful amplifier, whether the amplifier is bridged or single-ended. A direct consequence of the increased power delivered to the load by a bridge amplifier is an increase in internal power dissipation. Equation 1 states the maximum power dissipation point for a bridge amplifier operating at a given supply voltage and driving a specified output load.

$$P_{D_{MAX}} = 4 * (V_{DD})^2 / (2\pi^2 R_L) \quad (1)$$

Since the LM4871 has two operational amplifiers in one package, the maximum internal power dissipation is 4 times that of a single-ended amplifier. Even with this substantial increase in power dissipation, the LM4871 does not require heatsinking under most operating conditions and output loading. From Equation 1, assuming a 5V power supply and an 8 Ω load, the maximum power dissipation point is 625 mW. The maximum power dissipation point obtained from Equation 1 must not be greater than the power dissipation that results from Equation 2:

$$P_{D_{MAX}} = (T_{J_{MAX}} - T_A) / \theta_{JA} \quad (2)$$

For package M08A, $\theta_{JA} = 140^\circ\text{C/W}$, and for package N08E, $\theta_{JA} = 107^\circ\text{C/W}$ assuming free air operation. $T_{J_{MAX}} = 150^\circ\text{C}$ for the LM4871. The θ_{JA} can be decreased by using some form of heat sinking. The resultant θ_{JA} will be the summation of the θ_{JC} , θ_{CS} , and θ_{SA} . θ_{JC} is the junction to case of the

package, θ_{CS} is the case to heat sink thermal resistance and θ_{SA} is the heat sink to ambient thermal resistance. By adding additional copper area around the LM4871, the θ_{JA} can be reduced from its free air value of 140 $^\circ\text{C/W}$ for package M08A. Depending on the ambient temperature, T_A , and the θ_{JA} , Equation 2 can be used to find the maximum internal power dissipation supported by the IC packaging. If the result of Equation 1 is greater than that of Equation 2, then either the supply voltage must be decreased, the load impedance increased, the θ_{JA} decreased, or the ambient temperature reduced. For the typical application of a 5V power supply, with an 8 Ω load, and no additional heatsinking, the maximum ambient temperature possible without violating the maximum junction temperature is approximately 61 $^\circ\text{C}$ provided that device operation is around the maximum power dissipation point and assuming surface mount packaging. Internal power dissipation is a function of output power. If typical operation is not around the maximum power dissipation point, the ambient temperature can be increased. Refer to the **Typical Performance Characteristics** curves for power dissipation information for different output powers and output loading.

POWER SUPPLY BYPASSING

As with any amplifier, proper supply bypassing is critical for low noise performance and high power supply rejection. The capacitor location on both the bypass and power supply pins should be as close to the device as possible. Typical applications employ a 5V regulator with 10 μF and a 0.1 μF bypass capacitors which aid in supply stability. This does not eliminate the need for bypassing the supply nodes of the LM4871. The selection of bypass capacitors, especially C_B , is dependent upon PSRR requirements, click and pop performance as explained in the section, **Proper Selection of External Components**, system cost, and size constraints.

SHUTDOWN FUNCTION

In order to reduce power consumption while not in use, the LM4871 contains a shutdown pin to externally turn off the amplifier's bias circuitry. This shutdown feature turns the amplifier off when a logic high is placed on the shutdown pin. The trigger point between a logic low and logic high level is typically half-supply. It is best to switch between ground and supply to provide maximum device performance. By switching the shutdown pin to V_{DD} , the LM4871 supply current draw will be minimized in idle mode. While the device will be disabled with shutdown pin voltages less than V_{DD} , the idle current may be greater than the typical value of 0.6 μA . In either case, the shutdown pin should be tied to a definite voltage to avoid unwanted state changes.

In many applications, a microcontroller or microprocessor output is used to control the shutdown circuitry which provides a quick, smooth transition into shutdown. Another solution is to use a single-pole, single-throw switch in conjunction with an external pull-up resistor. When the switch is closed, the shutdown pin is connected to ground and enables the amplifier. If the switch is open, then the external pull-up resistor will disable the LM4871. This scheme guarantees that the shutdown pin will not float thus preventing unwanted state changes.

PROPER SELECTION OF EXTERNAL COMPONENTS

Proper selection of external components in applications using integrated power amplifiers is critical to optimize device and system performance. While the LM4871 is tolerant of

Application Information (Continued)

external component combinations, consideration to component values must be used to maximize overall system quality.

The LM4871 is unity-gain stable which gives a designer maximum system flexibility. The LM4871 should be used in low gain configurations to minimize THD+N values, and maximize the signal to noise ratio. Low gain configurations require large input signals to obtain a given output power. Input signals equal to or greater than 1 Vrms are available from sources such as audio codecs. Please refer to the section, **Audio Power Amplifier Design**, for a more complete explanation of proper gain selection.

Besides gain, one of the major considerations is the closed-loop bandwidth of the amplifier. To a large extent, the bandwidth is dictated by the choice of external components shown in *Figure 1*. The input coupling capacitor, C_i , forms a first order high pass filter which limits low frequency response. This value should be chosen based on needed frequency response for a few distinct reasons.

Selection Of Input Capacitor Size

Large input capacitors are both expensive and space hungry for portable designs. Clearly, a certain sized capacitor is needed to couple in low frequencies without severe attenuation. But in many cases the speakers used in portable systems, whether internal or external, have little ability to reproduce signals below 100 Hz to 150 Hz. Thus, using a large input capacitor may not increase actual system performance.

In addition to system cost and size, click and pop performance is effected by the size of the input coupling capacitor, C_i . A larger input coupling capacitor requires more charge to reach its quiescent DC voltage (nominally $1/2 V_{DD}$). This charge comes from the output via the feedback and is apt to create pops upon device enable. Thus, by minimizing the capacitor size based on necessary low frequency response, turn-on pops can be minimized.

Besides minimizing the input capacitor size, careful consideration should be paid to the bypass capacitor value. Bypass capacitor, C_B , is the most critical component to minimize turn-on pops since it determines how fast the LM4871 turns on. The slower the LM4871's outputs ramp to their quiescent DC voltage (nominally $1/2 V_{DD}$), the smaller the turn-on pop. Choosing C_B equal to $1.0 \mu\text{F}$ along with a small value of C_i (in the range of $0.1 \mu\text{F}$ to $0.39 \mu\text{F}$), should produce a virtually clickless and popless shutdown function. While the device will function properly, (no oscillations or motorboating), with C_B equal to $0.1 \mu\text{F}$, the device will be much more susceptible to turn-on clicks and pops. Thus, a value of C_B equal to $1.0 \mu\text{F}$ is recommended in all but the most cost sensitive designs.

AUDIO POWER AMPLIFIER DESIGN

Design a 1W/8Ω Audio Amplifier

Given:

Power Output	1 Wrms
Load Impedance	8Ω
Input Level	1 Vrms
Input Impedance	20 kΩ
Bandwidth	100 Hz–20 kHz \pm 0.25 dB

A designer must first determine the minimum supply rail to obtain the specified output power. By extrapolating from the Output Power vs Supply Voltage graphs in the **Typical Performance Characteristics** section, the supply rail can be easily found. A second way to determine the minimum supply rail is to calculate the required V_{opeak} using Equation 3 and add the output voltage. Using this method, the minimum supply voltage would be $(V_{\text{opeak}} + (V_{\text{ODTOP}} + V_{\text{ODBOT}}))$, where V_{ODBOT} and V_{ODTOP} are extrapolated from the Dropout Voltage vs Supply Voltage curve in the **Typical Performance Characteristics** section.

$$V_{\text{opeak}} = \sqrt{(2R_L P_O)} \quad (3)$$

Using the Output Power vs Supply Voltage graph for an 8Ω load, the minimum supply rail is 4.6V. But since 5V is a standard voltage in most applications, it is chosen for the supply rail. Extra supply voltage creates headroom that allows the LM4871 to reproduce peaks in excess of 1W without producing audible distortion. At this time, the designer must make sure that the power supply choice along with the output impedance does not violate the conditions explained in the **Power Dissipation** section.

Once the power dissipation equations have been addressed, the required differential gain can be determined from Equation 4.

$$A_{VD} \geq \sqrt{(P_O R_L)} / (V_{IN}) = V_{\text{orms}} / V_{\text{inrms}} \quad (4)$$

$$R_f / R_i = A_{VD} / 2 \quad (5)$$

From Equation 4, the minimum A_{VD} is 2.83; use $A_{VD} = 3$.

Since the desired input impedance was 20 kΩ, and with a A_{VD} impedance of 2, a ratio of 1.5:1 of R_f to R_i results in an allocation of $R_i = 20 \text{ k}\Omega$ and $R_f = 30 \text{ k}\Omega$. The final design step is to address the bandwidth requirements which must be stated as a pair of -3 dB frequency points. Five times away from a -3 dB point is 0.17 dB down from passband response which is better than the required $\pm 0.25 \text{ dB}$ specified.

$$f_L = 100 \text{ Hz} / 5 = 20 \text{ Hz}$$

$$f_H = 20 \text{ kHz} * 5 = 100 \text{ kHz}$$

As stated in the **External Components** section, R_i in conjunction with C_i create a highpass filter.

$$C_i \geq 1 / (2\pi * 20 \text{ k}\Omega * 20 \text{ Hz}) = 0.397 \mu\text{F}; \text{ use } 0.39 \mu\text{F}$$

The high frequency pole is determined by the product of the desired frequency pole, f_H , and the differential gain, A_{VD} . With a $A_{VD} = 3$ and $f_H = 100 \text{ kHz}$, the resulting GBWP = 150 kHz which is much smaller than the LM4871 GBWP of 4 MHz. This figure displays that if a designer has a need to design an amplifier with a higher differential gain, the LM4871 can still be used without running into bandwidth limitations.

Physical Dimensions inches (millimeters) unless otherwise noted

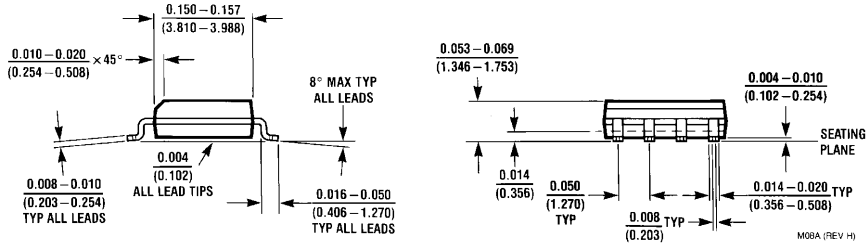
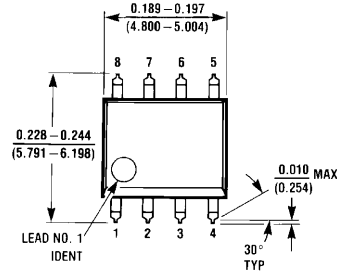

Order Number LM4871M
NS Package Number M08A

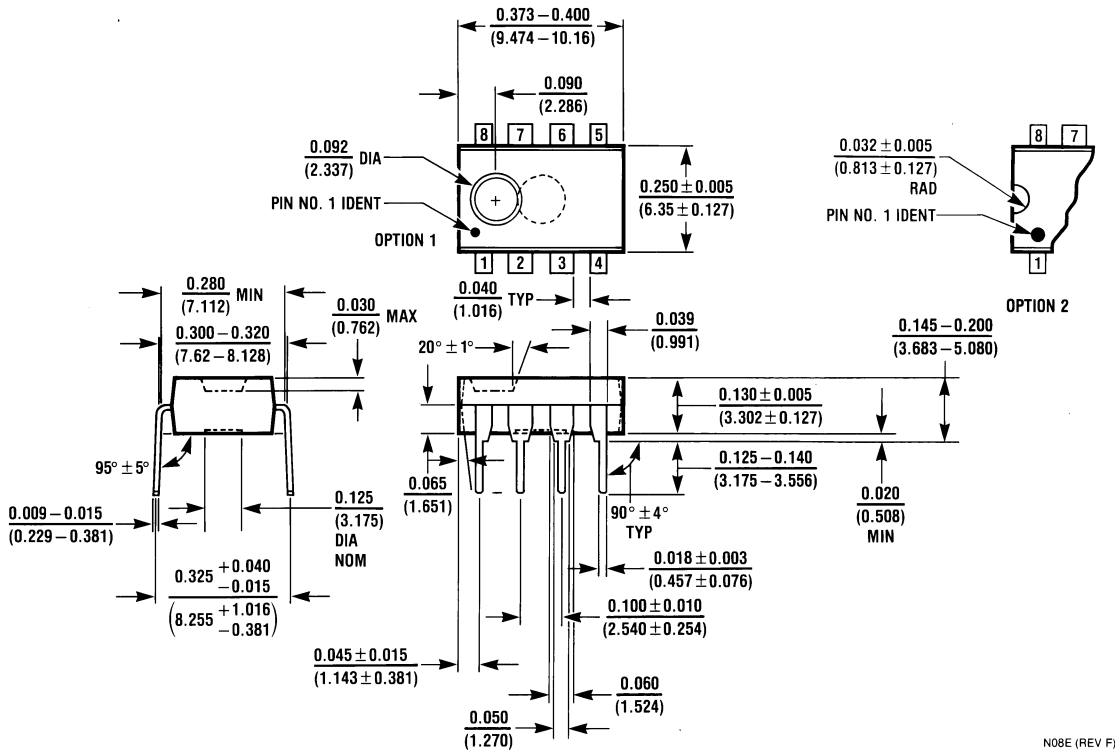

Order Number LM4871N
NS Package Number N08E

Notes

LIFE SUPPORT POLICY

NATIONAL'S PRODUCTS ARE NOT AUTHORIZED FOR USE AS CRITICAL COMPONENTS IN LIFE SUPPORT DEVICES OR SYSTEMS WITHOUT THE EXPRESS WRITTEN APPROVAL OF THE PRESIDENT AND GENERAL COUNSEL OF NATIONAL SEMICONDUCTOR CORPORATION. As used herein:

1. Life support devices or systems are devices or systems which, (a) are intended for surgical implant into the body, or (b) support or sustain life, and whose failure to perform when properly used in accordance with instructions for use provided in the labeling, can be reasonably expected to result in a significant injury to the user.
2. A critical component is any component of a life support device or system whose failure to perform can be reasonably expected to cause the failure of the life support device or system, or to affect its safety or effectiveness.



National Semiconductor Corporation
Americas
Tel: 1-800-272-9959
Fax: 1-800-737-7018
Email: support@nsc.com
www.national.com

National Semiconductor Europe
Fax: +49 (0) 180-530 85 86
Email: europe.support@nsc.com
Deutsch Tel: +49 (0) 69 9508 6208
English Tel: +44 (0) 870 24 0 2171
Français Tel: +33 (0) 1 41 91 8790

National Semiconductor Asia Pacific Customer Response Group
Tel: 65-2544466
Fax: 65-2504466
Email: ap.support@nsc.com

National Semiconductor Japan Ltd.
Tel: 81-3-5639-7560
Fax: 81-3-5639-7507