

## Small Signal Product

**300mW, NPN Small Signal Transistor**
**FEATURES**

- Epitaxial planar die construction
- Surface device type mounting
- Moisture sensitivity level 1
- Matte Tin (Sn) lead finish with Nickel (Ni) underplate
- Pb free version and RoHS compliant
- Packing code with suffix "G" means green compound (halogen-free)

**SOT-23**

**MECHANICAL DATA**

- Case: SOT- 23, molded plastic
- Terminal: Matte tin plated, lead free, solderable per MIL-STD-202, Method 208 guaranteed
- High temperature soldering guaranteed: 260°C/10s
- Weight: 8 mg (approximately)
- Marking Code: 1E.

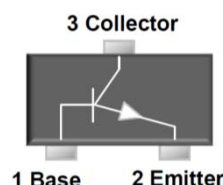

MAXIMUM RATINGS AND ELECTRICAL CHARACTERISTICS (T <sub>A</sub> =25°C unless otherwise noted)			
PARAMETER	SYMBOL	VALUE	UNIT
Power Dissipation	P <sub>D</sub>	300	mW
Collector-Base Voltage	V <sub>CB0</sub>	60	V
Collector-Emitter Voltage	V <sub>CEO</sub>	40	V
Emitter-Base Voltage	V <sub>EBO</sub>	6	V
Collector Current	I <sub>C</sub>	200	mA
Junction and Storage Temperature Range	T <sub>J</sub> , T <sub>STG</sub>	-55 to +150	°C

Notes: Valid provided that electrodes are kept at ambient temperature

PARAMETER	SYMBOL	MIN	MAX	UNIT
Collector-Base Breakdown Voltage I <sub>C</sub> = 10 μA I <sub>E</sub> = 0	V <sub>(BR)CBO</sub>	60	-	V
Collector-Emitter Breakdown Voltage I <sub>C</sub> = 1 mA I <sub>B</sub> = 0	V <sub>(BR)CEO</sub>	40	-	V
Emitter-Base Breakdown Voltage I <sub>E</sub> = 10 μA I <sub>C</sub> = 0	V <sub>(BR)EBO</sub>	6	-	V
Collector Cut-off Current V <sub>CB</sub> = 60 V I <sub>E</sub> = 0	I <sub>CBO</sub>	-	0.1	μA
Collector Cut-off Current V <sub>CE</sub> = 30 V V <sub>BE(OFF)</sub> = 3 V	I <sub>CEO</sub>	-	50	nA
Emitter Cut-off Current V <sub>EB</sub> = 5 V I <sub>C</sub> = 0	I <sub>EBO</sub>	-	0.1	μA
DC Current Gain V <sub>CE</sub> = 1 V I <sub>C</sub> = 10 mA V <sub>CE</sub> = 1 V I <sub>C</sub> = 50 mA V <sub>CE</sub> = 1 V I <sub>C</sub> = 100 mA	h <sub>FE</sub>	100	400	
		60	-	
		30	-	
Collector-Emitter Saturation Voltage I <sub>C</sub> = 50 mA I <sub>B</sub> = 5 mA	V <sub>CE(sat)</sub>	-	0.3	V
Base-Emitter Saturation Voltage I <sub>C</sub> = 50 mA I <sub>B</sub> = 5 mA	V <sub>BE(sat)</sub>	-	0.95	V
Transition frequency V <sub>CE</sub> = 20 V I <sub>C</sub> = 10 mA f = 100MHz	f <sub>T</sub>	250	-	MHz
Delay time V <sub>CC</sub> = 3 V V <sub>BE</sub> = 0.5 V I <sub>C</sub> = 10 mA	t <sub>d</sub>	-	35	ns
Rise time I <sub>B1</sub> = 1.0 mA	t <sub>r</sub>	-	35	ns
Storage time V <sub>CC</sub> = 3 V I <sub>C</sub> = 10 mA	t <sub>s</sub>	-	200	ns
Fall time I <sub>B1</sub> = I <sub>B2</sub> = 1.0 mA	t <sub>f</sub>	-	50	ns

Small Signal Product

RATINGS AND CHARACTERISTICS CURVES

( $T_A=25^\circ\text{C}$  unless otherwise noted)

Fig.1 Typical Pulsed Current Gain vs. Collector Current

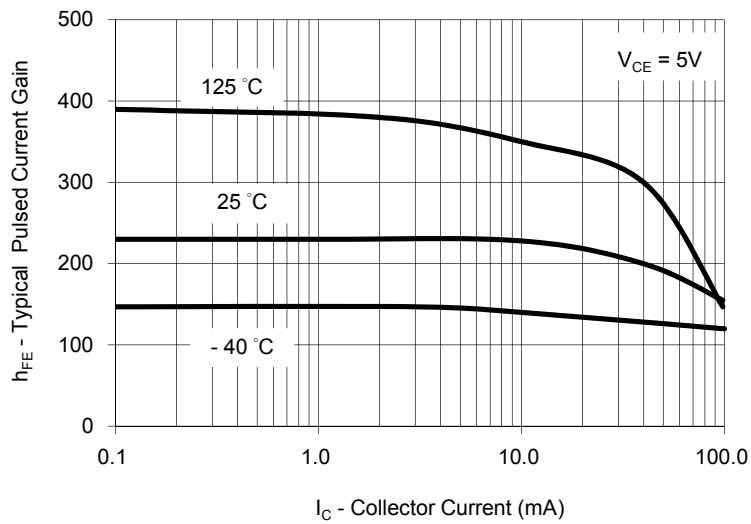

Fig. 2 Collector-Emitter Saturation Voltage vs. Collector Current

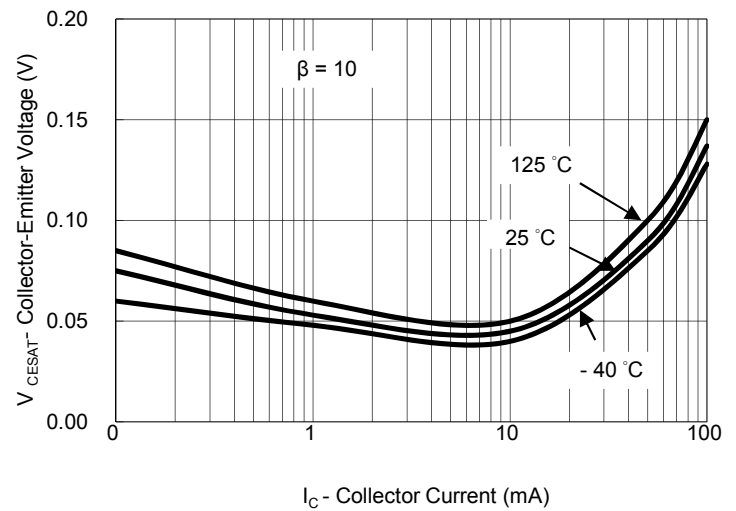

Fig. 3 Base-Emitter Saturation Voltage vs. Collector Current

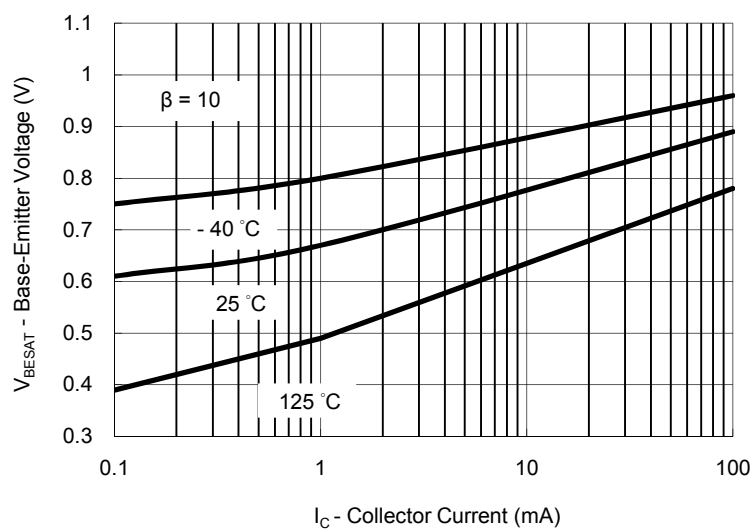

Fig. 4 Base-Emitter On Voltage vs. Collector Current

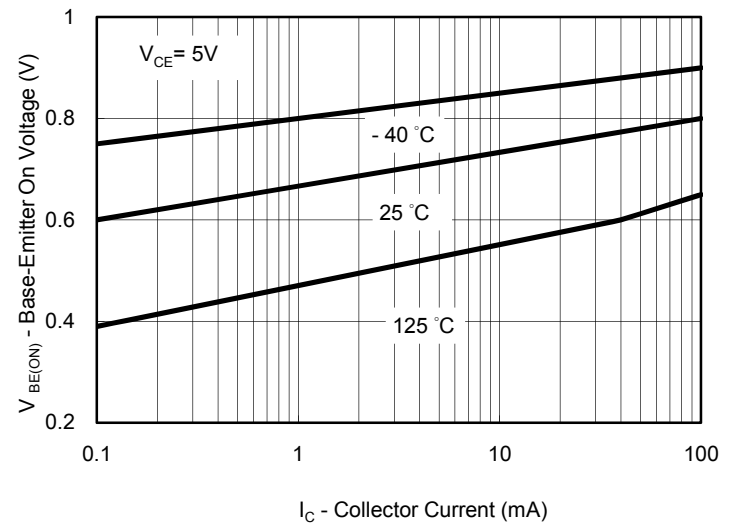

Fig. 5 Collector-Cutoff Current vs. Ambient Temperature

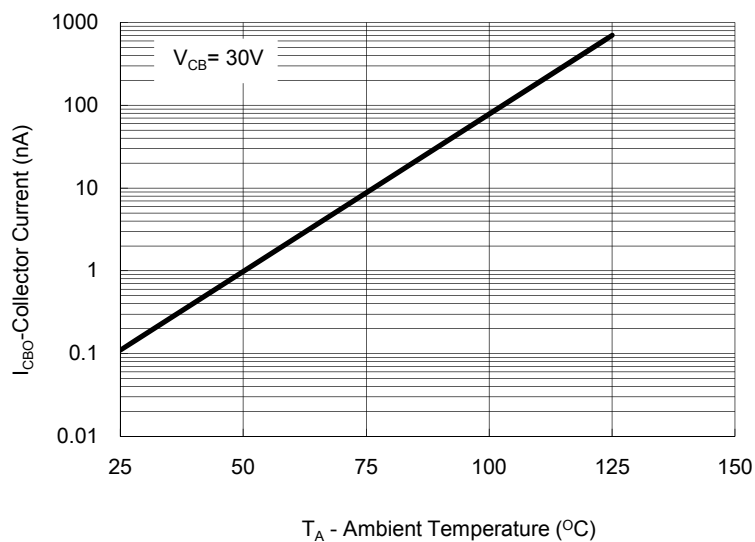
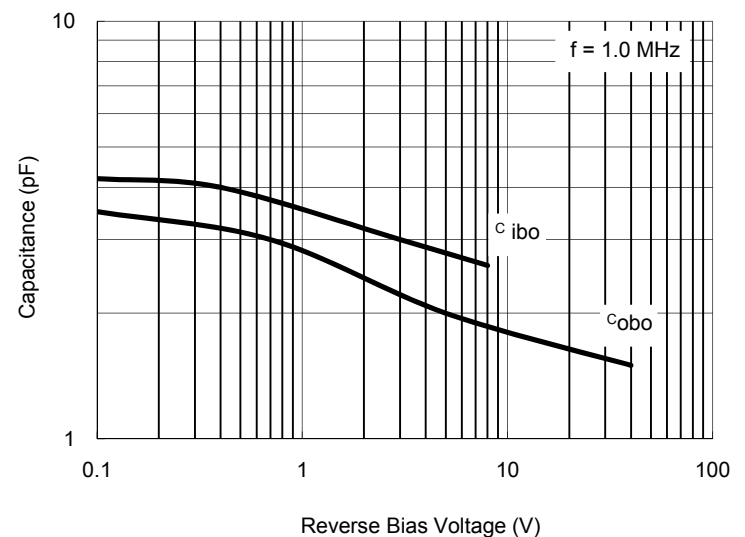

Fig. 6 Capacitance vs. Reverse Bias Voltage



Small Signal Product

ORDER INFORMATION (EXAMPLE)

MMBT3904L RFG

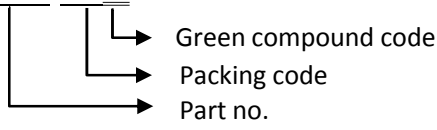

PACKAGE OUTLINE DIMENSIONS

**SOT-23**

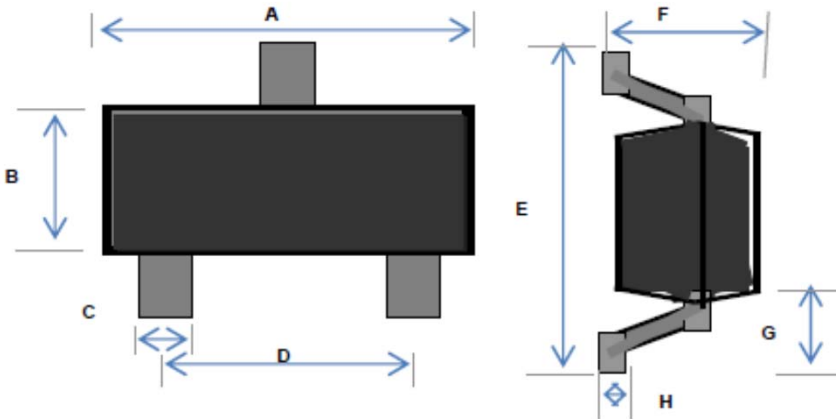

DIM.	Unit(mm)		Unit(inch)	
	Min	Max	Min	Max
A	2.70	3.10	0.106	0.122
B	1.10	1.50	0.043	0.059
C	0.30	0.51	0.012	0.020
D	1.78	2.04	0.070	0.080
E	2.10	2.64	0.083	0.104
F	0.89	1.30	0.035	0.051
G	0.55 REF		0.022 REF	
H	0.10 REF		0.004 REF	

SUGGEST PAD LAYOUT

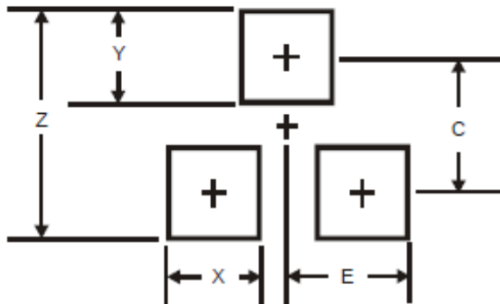

DIM	Unit (mm)	Unit (inch)
	TYP	TYP
Z	2.90	0.114
X	0.80	0.031
Y	0.90	0.035
C	2.00	0.079
E	1.35	0.053

### Notice

Specifications of the products displayed herein are subject to change without notice. TSC or anyone on its behalf, assumes no responsibility or liability for any errors or inaccuracies.

Information contained herein is intended to provide a product description only. No license, express or implied, to any intellectual property rights is granted by this document. Except as provided in TSC's terms and conditions of sale for such products, TSC assumes no liability whatsoever, and disclaims any express or implied warranty, relating to sale and/or use of TSC products including liability or warranties relating to fitness for a particular purpose, merchantability, or infringement of any patent, copyright, or other intellectual property right.

The products shown herein are not designed for use in medical, life-saving, or life-sustaining applications. Customers using or selling these products for use in such applications do so at their own risk and agree to fully indemnify TSC for any damages resulting from such improper use or sale.