

Power MOSFET Stage for Boost Converters

Module for Power Factor Correction

Single Phase Rectifier	Boost Diode	MOSFET
$V_{RRM} = 1600 \text{ V}$	$V_{RRM} = 600 \text{ V}$	$V_{DSS} = 600 \text{ V}$
$I_{DAV} = 106 \text{ A}$	$I_{F25} = 60 \text{ A}$	$I_{D25} = 50 \text{ A}$
$I_{FSM} = 300 \text{ A}$	$V_F(30A) = 2.24 \text{ V}$	$R_{DS(on)} = 120 \text{ m}\Omega$

Part name (Marking on product)

VUM33-06PH

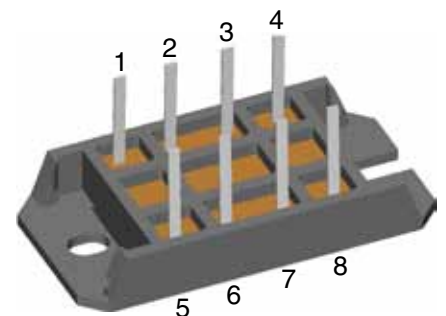
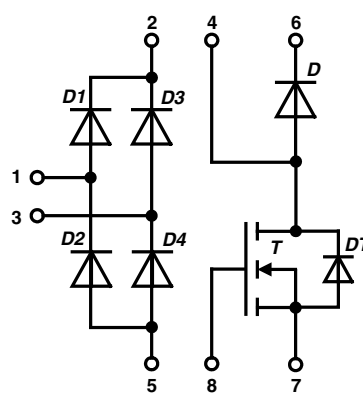

Features:

- Package with DCB ceramic base plate
- Soldering connections for PCB mounting
- Isolation voltage 3600 V~
- Low $R_{DS(on)}$ Polar™ MOSFET
- Low package inductance for high speed switching
- SONIC™ boost diode
 - fast and soft reverse recovery
 - low operating forward voltage

Advantages:

- 3 functions in one package
- Output power up to 8 kW
- No external isolation
- Easy to mount with two screws
- Suitable for wave soldering
- High temperature and power cycling capability
- Fits easily to all available PFC controller ICs

Package:

- "V1-Pack" standard outline
- Insulated copper base plate

Application:

- Power factor pre-conditioner for SMPS, UPS, battery chargers and inverters
- Boost topology for SMPS including 1~ rectifier bridge
- Power supply for welding equipment

MOSFET T				Ratings		
Symbol	Definitions	Conditions	min.	typ.	max.	Unit
V_{DSS}	drain source voltage		$T_{VJ} = 25^{\circ}C$		600	V
V_{GSS}	max. DC gate voltage	continuous			± 20	V
V_{GSM}	max. transient gate source voltage	transient			± 30	V
I_{D25}	drain current		$T_C = 25^{\circ}C$		50	A
I_{D80}			$T_C = 80^{\circ}C$		37	A
P_{tot}	total power dissipation		$T_C = 80^{\circ}C$		500	W
$R_{DS(on)}$	drain source on resistance	$I_D = 30\text{ A}; V_{GE} = 10\text{ V}$	$T_{VJ} = 25^{\circ}C$ $T_{VJ} = 125^{\circ}C$		120 240	m Ω m Ω
$V_{GS(th)}$	gate source threshold voltage	$I_C = 8\text{ mA}; V_{DS} = V_{GS}$	$T_{VJ} = 25^{\circ}C$	2.5	5.0	V
I_{DSS}	drain source leakage current	$V_{DS} = V_{DSS}; V_{GS} = 0\text{ V}$	$T_{VJ} = 25^{\circ}C$ $T_{VJ} = 125^{\circ}C$		50 500	μA μA
I_{GSS}	gate source leakage current	$V_{GS} = \pm 20\text{ V}; V_{DS} = 0\text{ V}$			± 500	nA
C_{iss}	input capacitance	$V_{DS} = 25\text{ V}; V_{GS} = 0\text{ V}; f = 1\text{ MHz}$		8.0		nF
$Q_{G(on)}$	total gate charge	$V_{DS} = 300\text{ V}; V_{GS} = 10\text{ V}; I_D = 50\text{ A}$		165		nC
$t_{d(on)}$	turn-on delay time	inductive load $V_{DS} = 380\text{ V}; I_D = 20\text{ A}$ $V_{GS} = 0/10\text{ V}; R_G = 4.7\ \Omega$ $R_{G\text{ eff}} = 5.5\ \Omega$ ¹⁾	$T_{VJ} = 25^{\circ}C$	56		ns
t_r	current rise time			12		ns
$t_{d(off)}$	turn-off delay time			110		ns
t_f	current fall time			12		ns
E_{on}	turn-on energy per pulse			0.3		mJ
E_{off}	turn-off energy per pulse			0.16		mJ
$t_{d(on)}$	turn-on delay time	inductive load $V_{DS} = 380\text{ V}; I_D = 20\text{ A}$ $V_{GS} = 0/10\text{ V}; R_G = 4.7\ \Omega$ $R_{G\text{ eff}} = 5.5\ \Omega$ ¹⁾	$T_{VJ} = 125^{\circ}C$	56		ns
t_r	current rise time			16		ns
$t_{d(off)}$	turn-off delay time			144		ns
t_f	current fall time			14		ns
E_{on}	turn-on energy per pulse			0.47		mJ
E_{off}	turn-off energy per pulse			0.20		mJ
R_{thJC}	thermal resistance junction to case				0.14	K/W
R_{thJH}	thermal resistance case to heatsink	with heat transfer paste (IXYS test setup)		0.18	0.24	K/W

¹⁾ $R_{G\text{ eff}}$ includes the driver resistance of 0.8 Ω

Boost Diode D

Symbol	Definitions	Conditions	Ratings			Unit
			min.	typ.	max.	
V_{RRM}	max. repetitive reverse voltage				600	V
I_{F25}	forward current				60	A
I_{F80}					40	A
V_F	forward voltage	$I_F = 30 \text{ A}; V_{GE} = 0 \text{ V}$			2.24	V
					2.19	V
I_R	reverse current	$V_R = V_{RRM}$			30	μA
					2	mA
Q_{rr}	reverse recovery charge	$V_R = 380 \text{ V}$ $di_f/dt = -790 \text{ A}/\mu\text{s}$ ²⁾ $I_F = 20 \text{ A}$			0.24	μC
I_{RM}	max. reverse recovery current				11.7	A
t_{rr}	reverse recovery time				43	ns
E_{rec}	reverse recovery energy				0.026	mJ
Q_{rr}	reverse recovery charge	$V_R = 380 \text{ V}$ $di_f/dt = -700 \text{ A}/\mu\text{s}$ ²⁾ $I_F = 20 \text{ A}$			0.59	μC
I_{RM}	max. reverse recovery current				15.9	A
t_{rr}	reverse recovery time				55	ns
E_{rec}	reverse recovery energy				0.076	mJ
R_{thJC}	thermal resistance junction to case	with heat transfer paste (IXYS test setup)			0.72	K/W
R_{thJH}	thermal resistance case to heatsink				0.84	0.96

²⁾ Test setup: MOSFET T driven with $R_{G\text{eff}} = 5.5 \Omega$ and $V_{GS} = 0/10 \text{ V}$
Input Rectifier Bridge D1 - D4

Symbol	Definitions	Conditions	Ratings			Unit	
			min.	typ.	max.		
V_{RRM}	max. repetitive reverse voltage				1600	V	
I_{DAV}	average forward output current	sine 180°			106	A	
I_{FAVM}	max. average forward current (per diode)	rect.; $d = 0.5$			57	A	
I_{F25}	forward current	DC			106	A	
I_{F80}	forward current	DC			71.5	A	
I_{FSM}	max. forward surge current	$t = 10 \text{ ms}; \text{ sine } 50 \text{ Hz}$			300	A	
					170	A	
I^2t	I^2t value for fusing	$t = 10 \text{ ms}; \text{ sine } 50 \text{ Hz}$			450	A^2s	
					240	A^2s	
P_{tot}	total power dissipation				110	W	
V_F	forward voltage	$I_F = 50 \text{ A}$			1.39	V	
					1.39	V	
I_R	reverse current	$V_R = V_{RRM}$			20	μA	
					1.5	mA	
R_{thJC}	thermal resistance junction to case	(per diode)			0.64	K/W	
R_{thJH}	thermal resistance case to heatsink	with heat transfer paste (IXYS test setup)			0.72	0.85	K/W

Module

Symbol	Definitions	Conditions	Ratings			Unit
			min.	typ.	max.	
T_{VJ}	operating temperature		-40		150	°C
T_{VJM}	max. virtual junction temperature		-40		150	°C
T_{stg}	storage temperature		-40		125	°C
V_{ISOL}	isolation voltage	$I_{ISOL} \leq 1 \text{ mA}; 50/60 \text{ Hz}; 1 \text{ sec.}$			3600	V~
M_d	mounting torque (M5)		2		2.5	Nm
Weight				35		g

 $T_C = 25^\circ\text{C}$ unless otherwise stated

Outline Drawing

Dimensions in mm (1 mm = 0.0394")

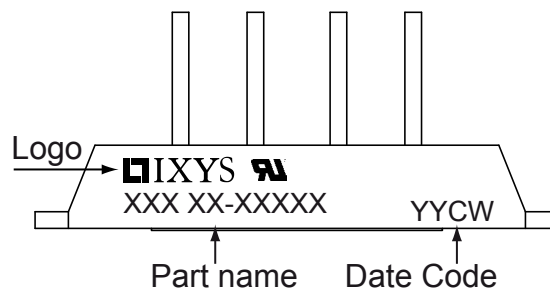
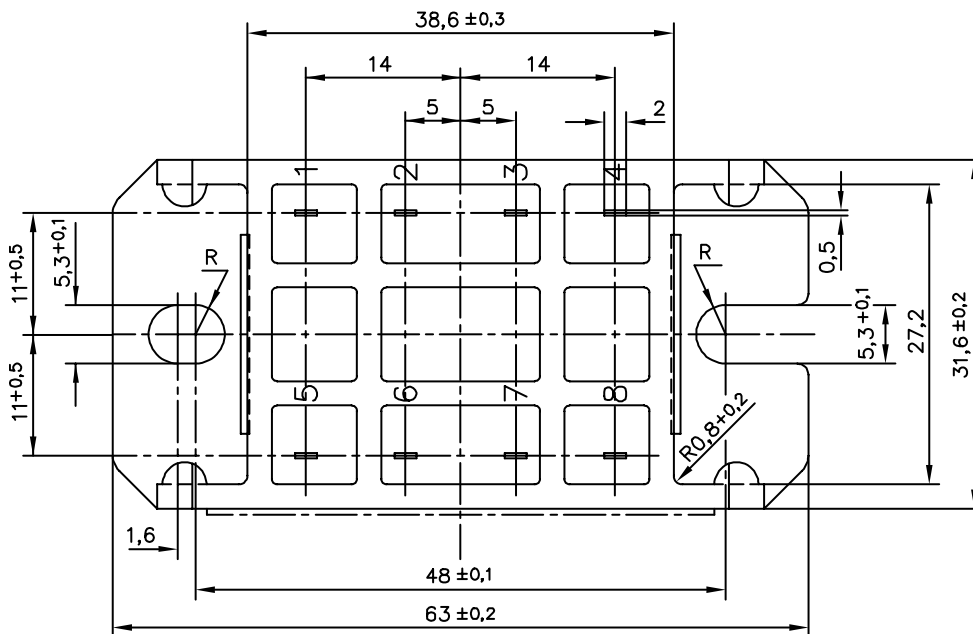
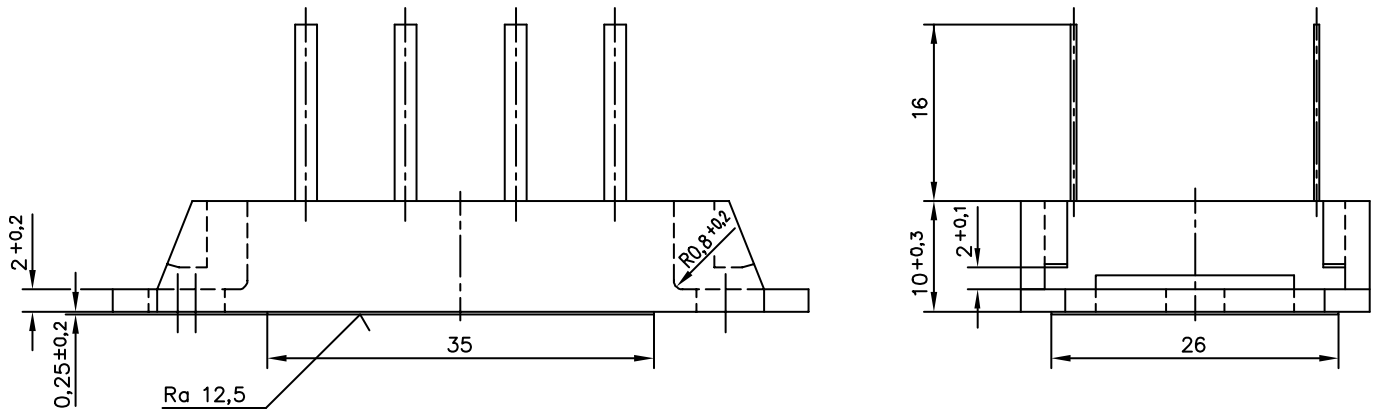
Product Ordering

Ordering	Part Name	Marking on Product	Delivering Mode	Base Qty	Ordering Code
Standard	VUM 33-06PH	VUM 33-06PH	Box	10	508843

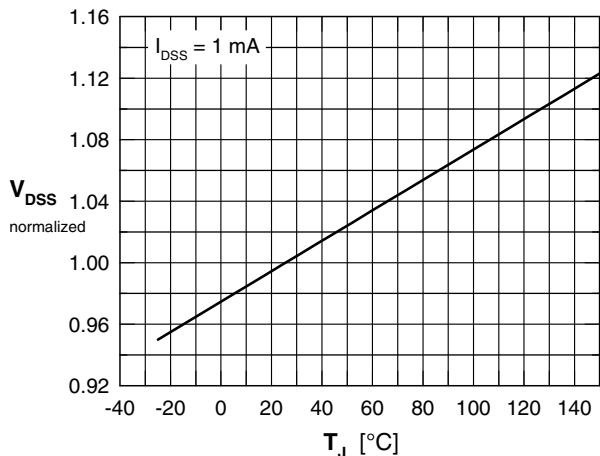

Fig. 1 Drain source breakdown voltage V_{DSS} versus junction temperature

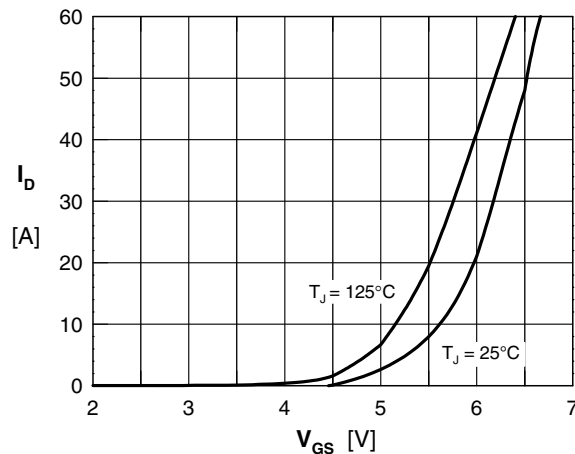

Fig. 2 Typical transfer characteristics

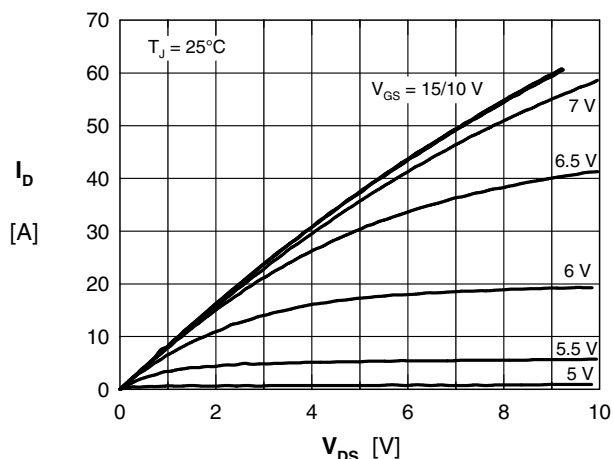

Fig. 3 Typical output characteristics

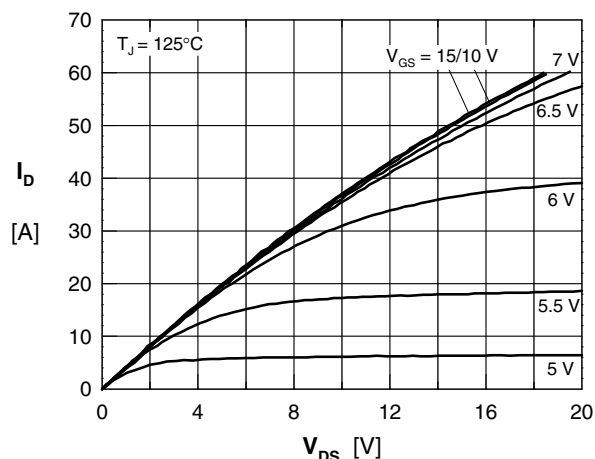

Fig. 4 Typical output characteristics

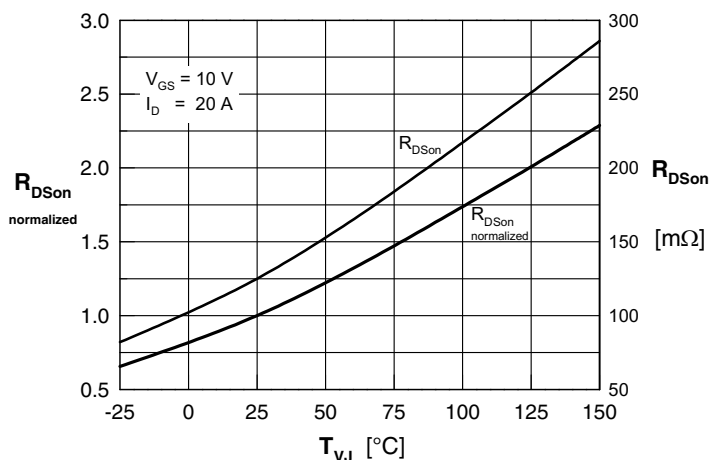

Fig. 5 Drain source on-state resistance $R_{DS(on)}$ versus junction temperature

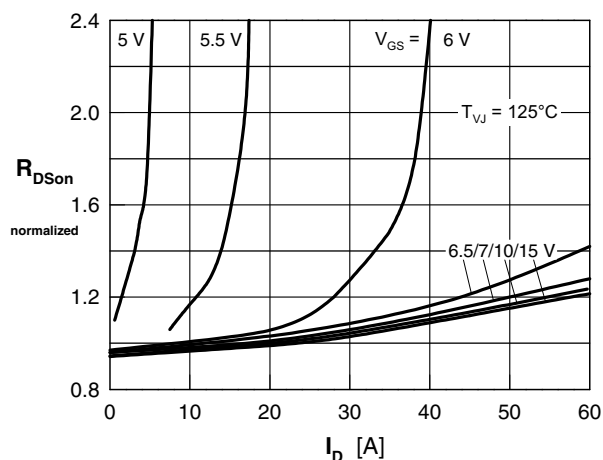

Fig. 6 Drain source on-state resistance $R_{DS(on)}$ versus I_D normalized to $R_{DS(on)}$ at $V_{GS} = 10 \text{ V}$ and $I_D = 20 \text{ A}$

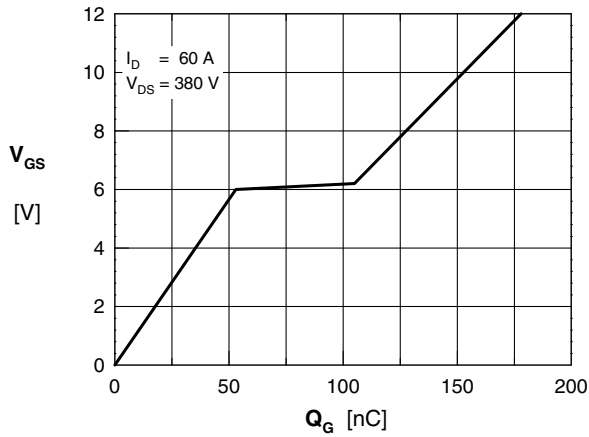

Fig. 7 Gate charge characteristics

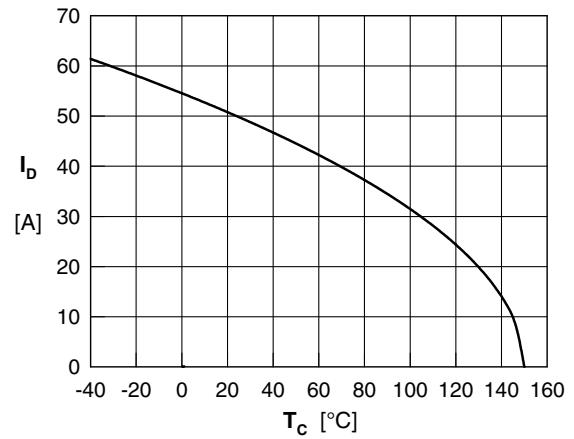
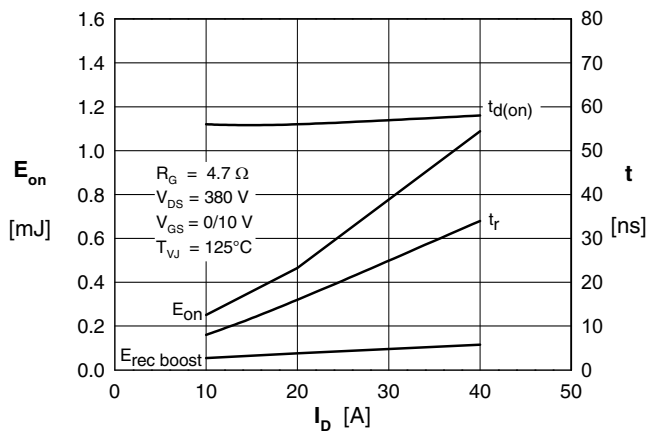

 Fig. 8 Drain current I_D versus case temperature T_C

Fig. 9 Typ. turn-on energy and switching times versus drain current, inductive switching

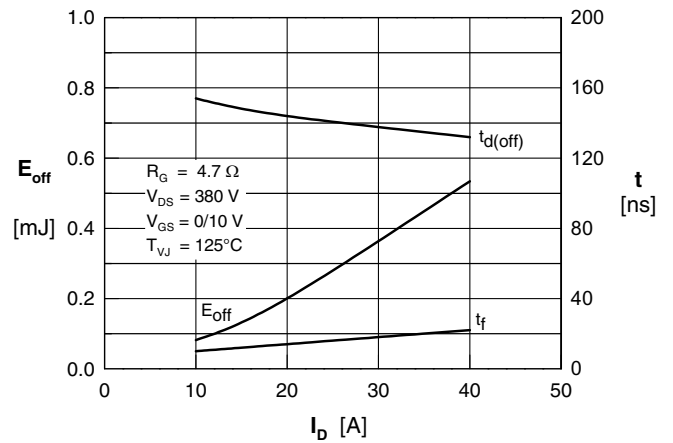

Fig. 10 Typ. turn-off energy and switching times versus drain current, inductive switching

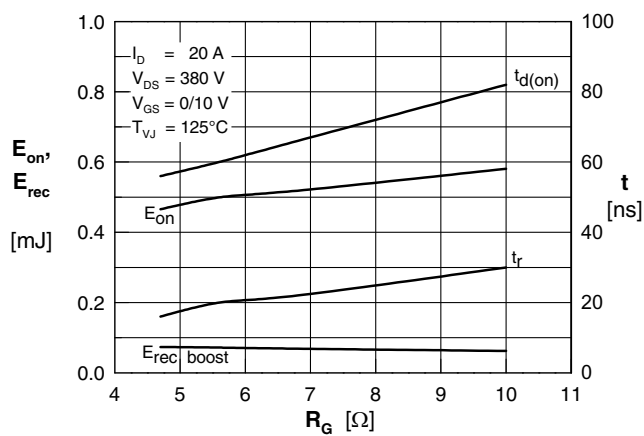

Fig. 11 Typ. turn-on energy and switching times versus gate resistor, inductive switching

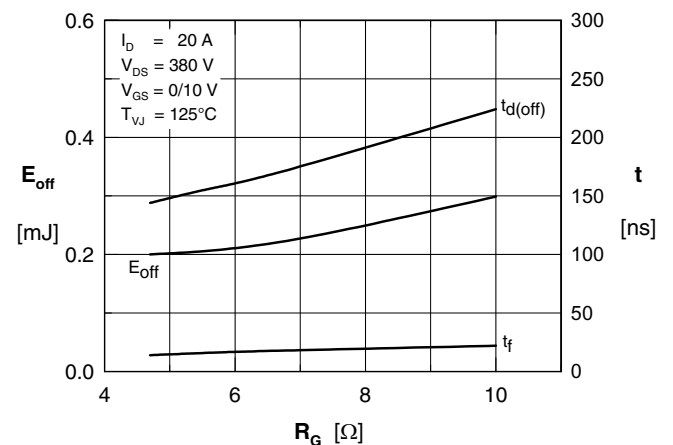

Fig. 12 Typ. turn-off energy and switching times versus gate resistor, inductive switching

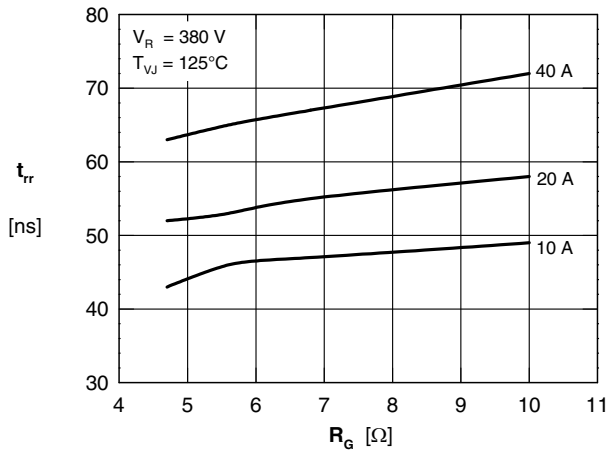

Fig. 13 Reverse recovery time t_{rr} of the boost diode versus R_G of boost MOSFET

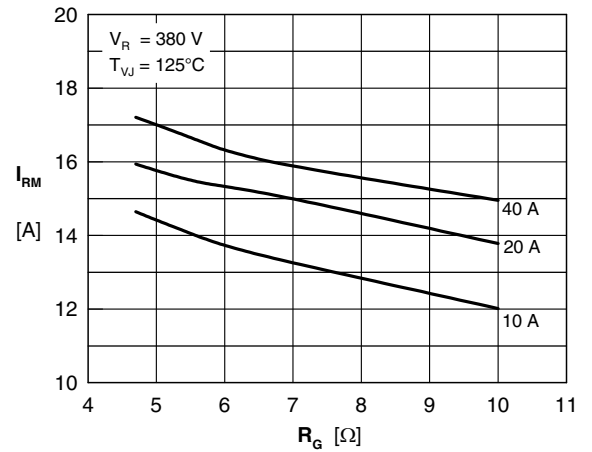

Fig. 14 Reverse recovery current I_{RM} of the boost diode versus R_G of the boost MOSFET

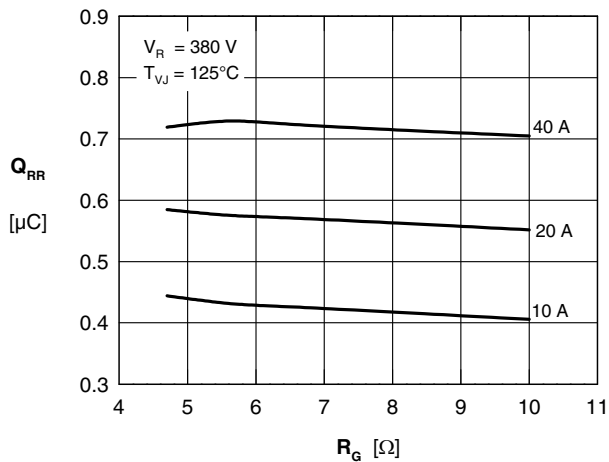

Fig. 15 Reverse recovery charge Q_{RR} of the boost diode versus R_G

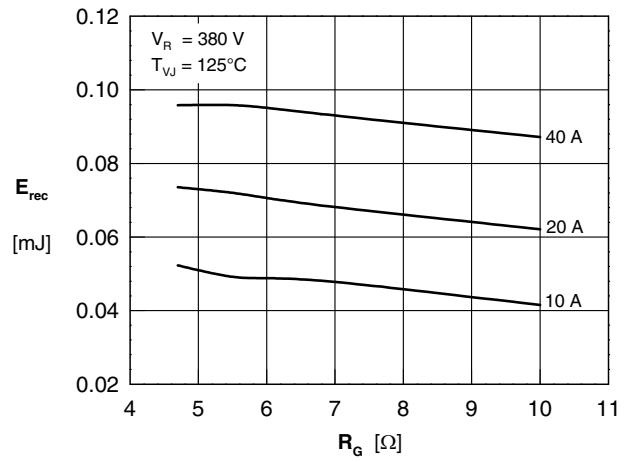

Fig. 16 Reverse recovery energy E_{rec} of the boost diode versus R_G

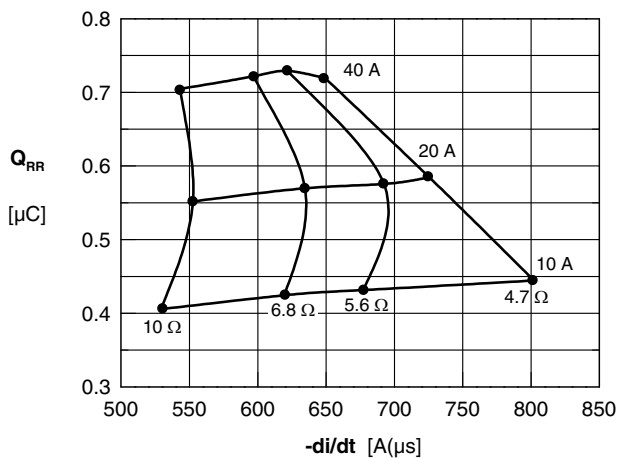

Fig. 17 Typ. turn off characteristics of the boost diode versus di/dt

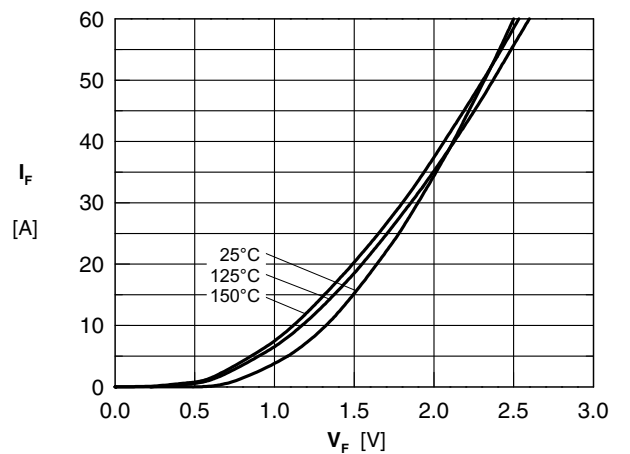

Fig. 18 Forward characteristics boost diode

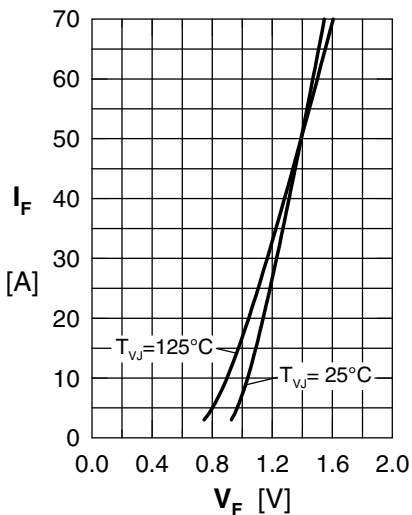

Fig. 19 Forward current vs. voltage drop of input rectifier diode

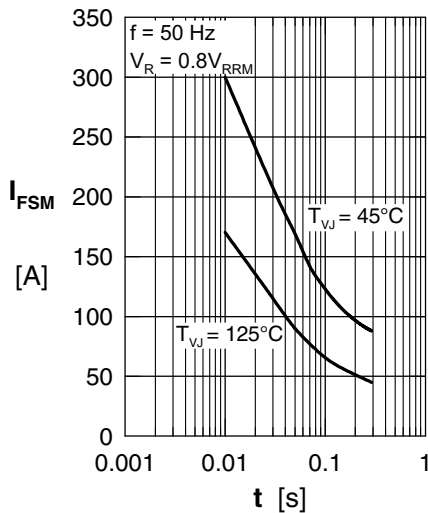

Fig. 20 Non-repetitive peak surge current (Rectifier Diodes)

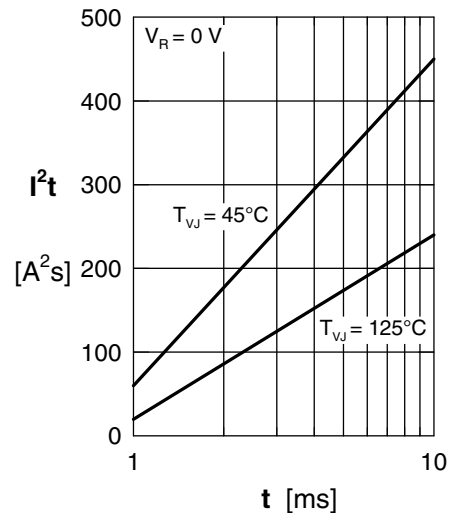

Fig. 21 I^2t for fusing (Rectifier Diodes)

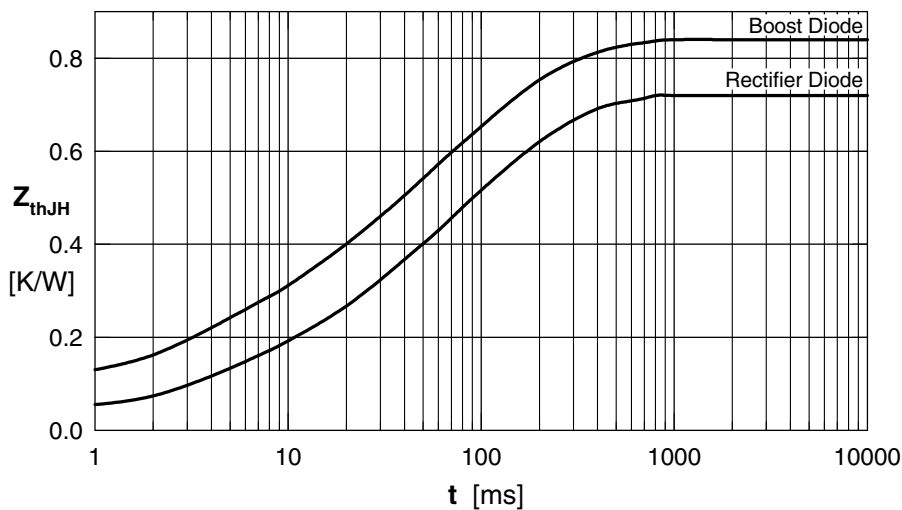

Fig. 22 Typ. transient thermal impedances of Boost Diode and Rectifier Diode

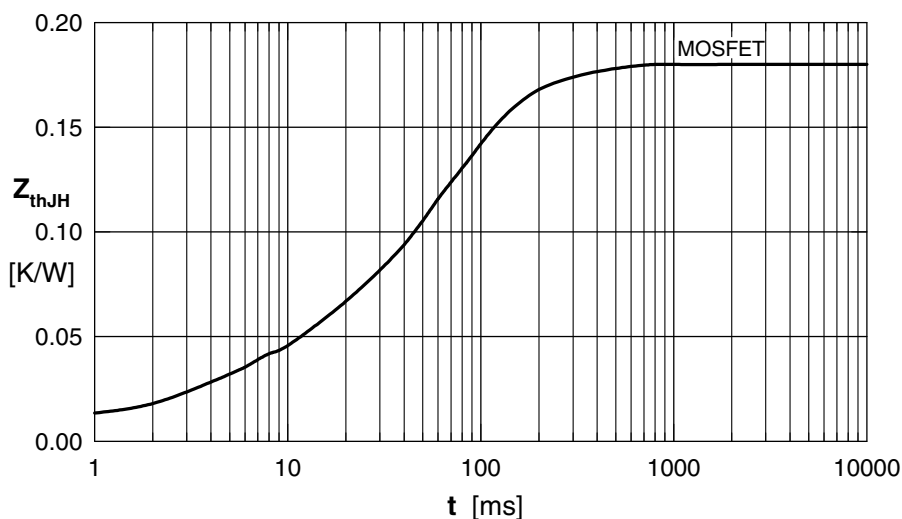

Fig. 23 Typ. transient thermal impedances of MOSFET