

# SMD Power Inductor 0624CDMCC/DS

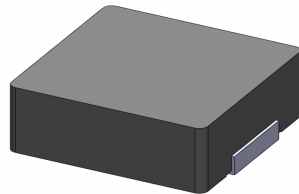

Halogen Free



## Description

- Metal compound molding type construction.
- Magnetically shielded.
- Low audible core noise.
- Suitable for large current.
- L × W × H: 7.3 × 6.8 × 2.4mm Max.
- Product weight: 0.6g (Ref.)
- Moisture Sensitivity Level: 1
- RoHS compliance.
- Halogen Free available.

## Dimension - [mm]

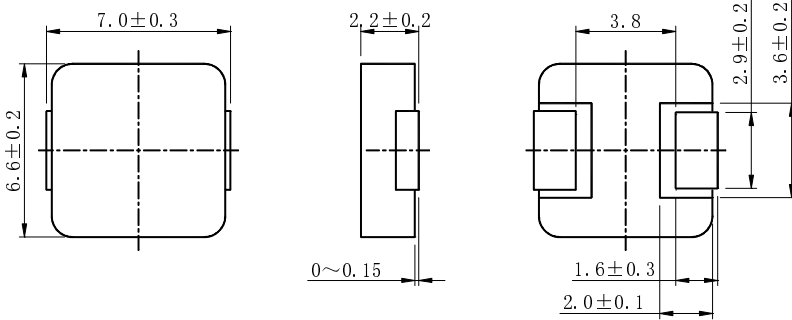

## Environmental Data

- Operating temperature range: -55°C ~ +125°C (including coil's self temperature rise)
- Storage temperature range: -55°C ~ +125°C
- Solder reflow temperature: 260 °C peak.

## Packaging

- Carrier tape and reel packaging.
- 1500pcs/Reel.

## Land pattern and Schematics - [mm]

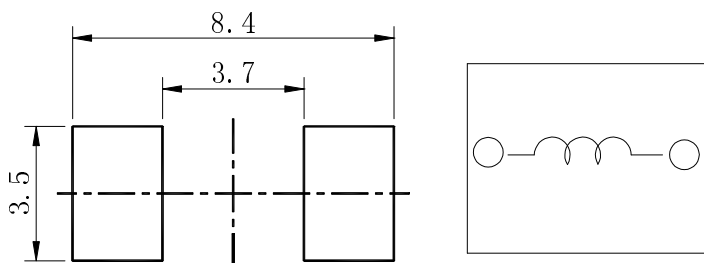

## Applications

- Ideally used in notebook, ultrabook, tablet PC, LCD display, Server application.
- High current, POL converters.
- Low profile, high current power supplies.
- Battery powered devices.
- DC/DC converters in distributed power systems.



### Electrical Characteristics

Part No.	Stamp	Inductance [Within] ( $\mu$ H) ※1	D.C.R (m $\Omega$ ) Max.(Typ.) at 25°C	Saturation Current (A) Max.(Typ.) (at 25°C) ※2	Temperature rise current (A) (Typ.) ※3
0624CDMCCDS-R22MC	R22	0.22 $\pm$ 20%	3.0(2.5)	30.6(36.1)	22.0
0624CDMCCDS-R33MC	R33	0.33 $\pm$ 20%	4.1(3.5)	24.2(28.5)	20.5
0624CDMCCDS-R47MC	R47	0.47 $\pm$ 20%	5.1(4.5)	20.8(24.5)	17.5
0624CDMCCDS-R56MC	R56	0.56 $\pm$ 20%	6.5(5.5)	17.0(20.0)	15.4
0624CDMCCDS-R68MC	R68	0.68 $\pm$ 20%	7.0(6.2)	16.0(18.8)	15.0
0624CDMCCDS-1R0MC	1R0	1.0 $\pm$ 20%	9.6(8.0)	13.7(16.2)	12.6
0624CDMCCDS-1R5MC	1R5	1.5 $\pm$ 20%	19.2(16.0)	12.7(15.0)	8.7
0624CDMCCDS-2R2MC	2R2	2.2 $\pm$ 20%	28.0(23.0)	10.9(12.8)	7.0
0624CDMCCDS-3R3MC	3R3	3.3 $\pm$ 20%	48.0(40.0)	9.0(10.6)	5.5
0624CDMCCDS-4R7MC	4R7	4.7 $\pm$ 20%	54.0(45.0)	6.5(7.6)	4.8
0624CDMCCDS-6R8MC	6R8	6.8 $\pm$ 20%	66.0(55.0)	5.7(6.7)	4.2
0624CDMCCDS-100MC	100	10.0 $\pm$ 20%	101.0(92.0)	4.7(5.5)	3.1
0624CDMCCDS-150MC	150	15.0 $\pm$ 20%	160.0(145.0)	3.1(3.7)	2.5
0624CDMCCDS-220MC	220	22.0 $\pm$ 20%	242.0(222.0)	2.7(3.2)	1.9

※1 Measuring frequency Inductance at 100kHz ,1.0V

※2 Saturation current: The value of DC current when the inductance is over 70% of its initial value. (at 25°C )

※3 Temperature rise current: The actual value of DC current when temperature of coil rise is

$\Delta T=40^{\circ}\text{C}$  ( $T_a=25^{\circ}\text{C}$ ) Board conditions: FR4, Copper=70  $\mu$  m, four-layer PWB, t=1.6mm.

# SMD Power Inductor 0624CDMCC/DS



## Saturation Current & Temperature Rise Graph

— L (20°C) —  $\Delta T$

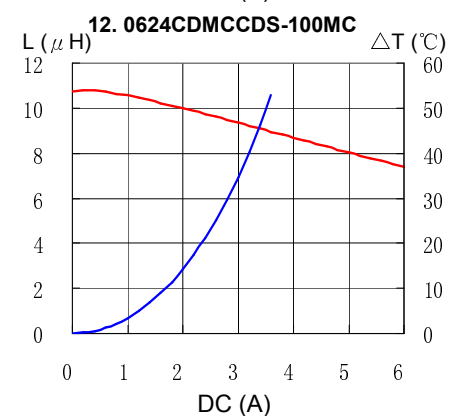
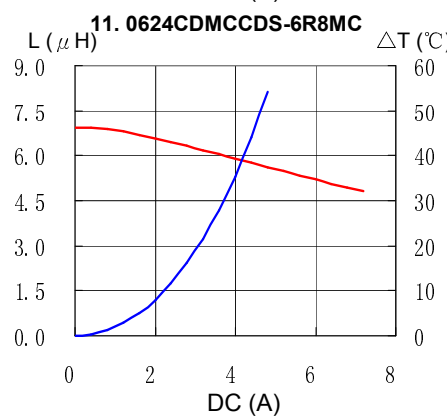
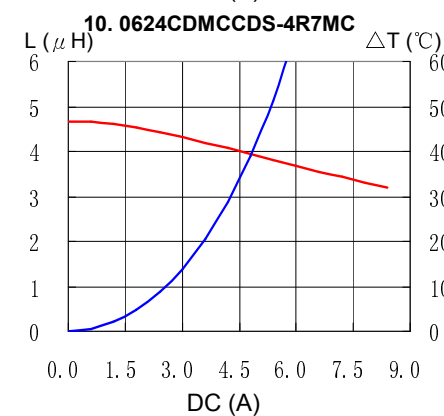
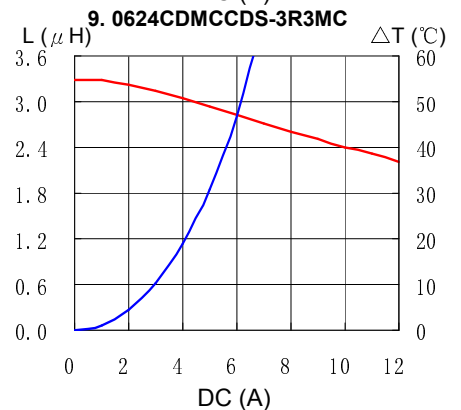
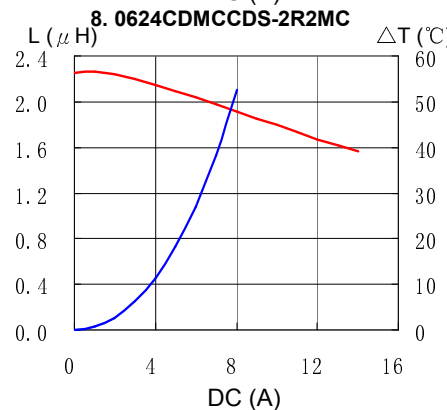
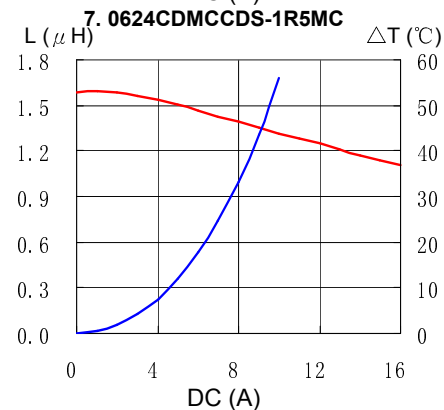
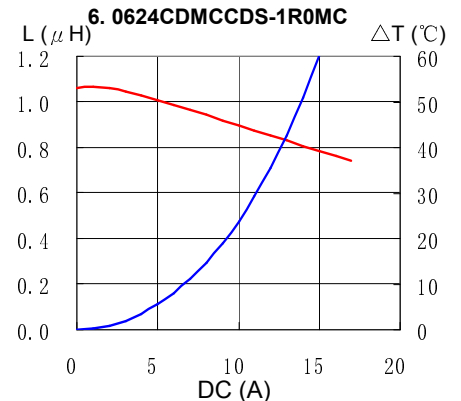
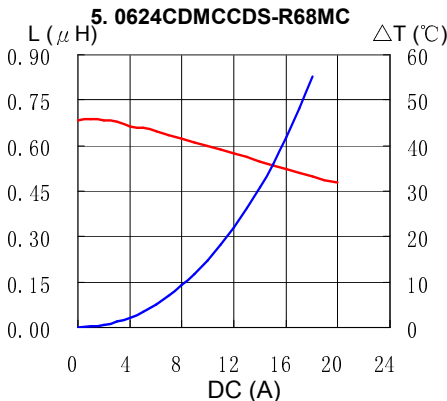
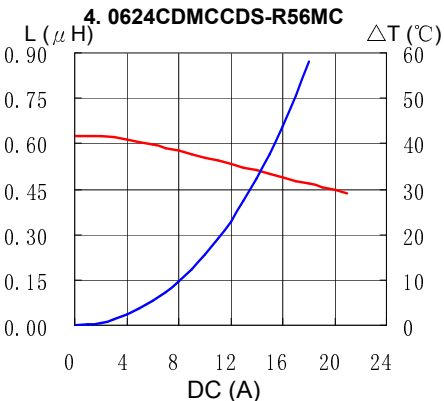
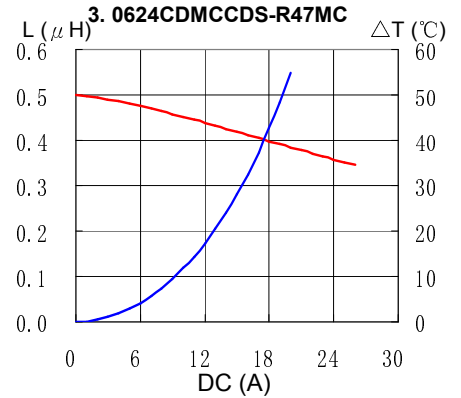
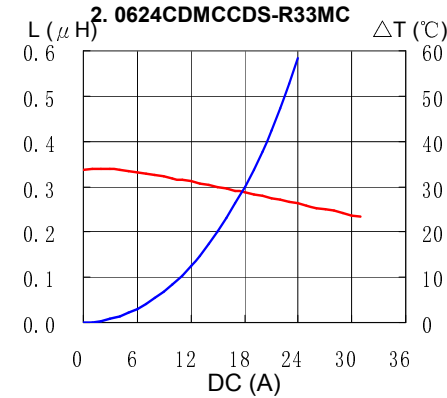
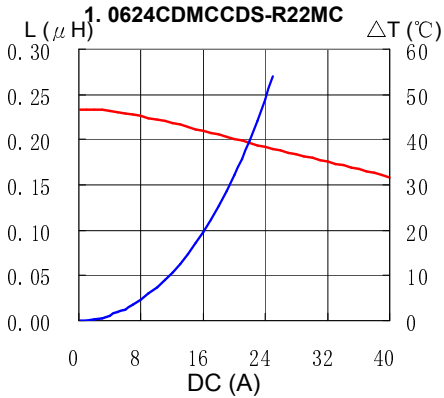

# SMD Power Inductor 0624CDMCC/DS



## Saturation Current & Temperature Rise Graph

— L (20°C) —  $\Delta T$

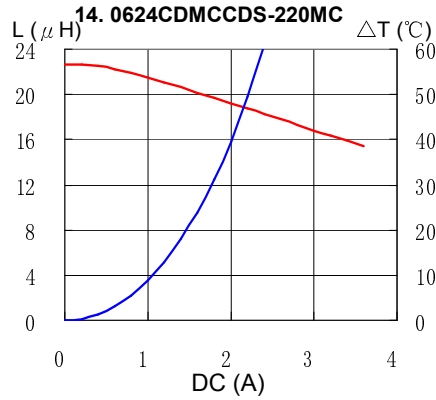
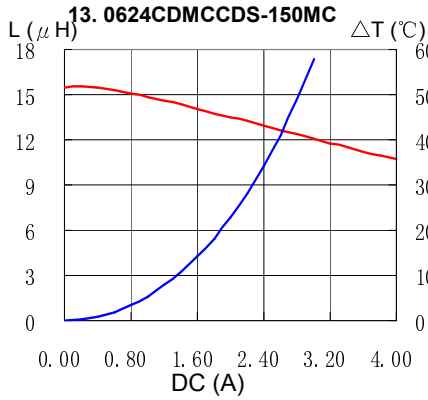

## Solder Reflow Condition

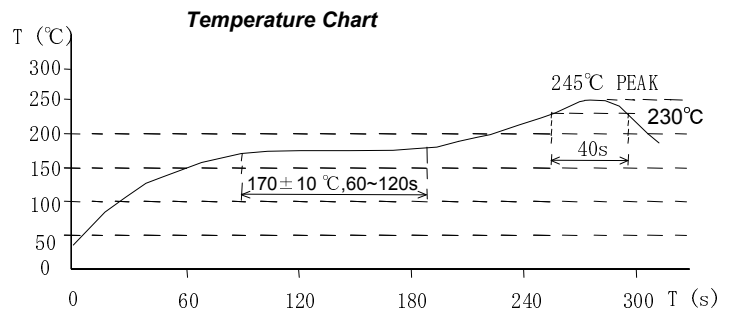
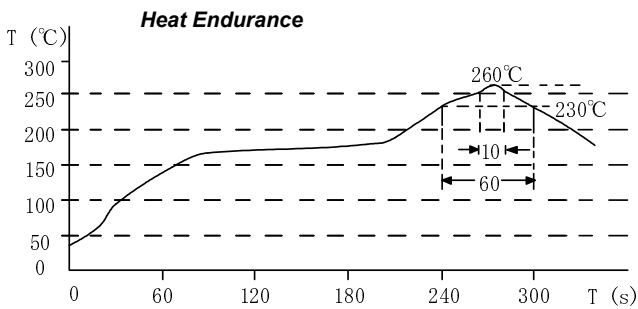

Please refer to the sales offices on our website - <http://www.sumida.com>

**Hong Kong**  
Tel. +852-2880-6781  
FAX. +852-2565-9600  
[sales@hk.sumida.com](mailto:sales@hk.sumida.com)

**Saitama (Japan)**  
Tel. +81-48-691-7300  
FAX. +81-48-691-7340  
[sales@jp.sumida.com](mailto:sales@jp.sumida.com)

**Chicago**  
Tel. +1-847-545-6700  
FAX. +1-847-545-6720  
[sales@us.sumida.com](mailto:sales@us.sumida.com)

**Shanghai**  
Tel. +86-21-5836-3299  
FAX. +86-21-5836-3266  
[shanghai.sales@cn.sumida.com](mailto:shanghai.sales@cn.sumida.com)

**Seoul**  
Tel. +82-2-6237-0777  
FAX. +82-2-6237-0778  
[sales@kr.sumida.com](mailto:sales@kr.sumida.com)

**Oberzell**  
Tel. +49-8591-937-0  
FAX. +49-8591-937-103  
[contact@eu.sumida.com](mailto:contact@eu.sumida.com)

**Shenzhen**  
Tel. +86-755-8291-0228  
FAX. +86-755-8291-0338  
[shenzhen.sales@cn.sumida.com](mailto:shenzhen.sales@cn.sumida.com)

**Singapore**  
Tel. +65-6296-3388  
FAX. +65-6841-4426  
[sales@sg.sumida.com](mailto:sales@sg.sumida.com)

**Neumarkt**  
Tel. +49-9181-4509-110  
FAX. +49-9181-4509-310  
[infocomp@eu.sumida.com](mailto:infocomp@eu.sumida.com)

**Taipei**  
Tel. +886-2-8751-2737  
FAX. +886-2-8751-2738  
[sales@tw.sumida.com](mailto:sales@tw.sumida.com)

**San Jose**  
Tel. +1-408-321-9660  
FAX. +1-408-321-9308  
[sales@us.sumida.com](mailto:sales@us.sumida.com)