



MSB40D THRU MSB40M

Voltage Range - 200 to 1000 Volts Current - 4.0 Ampere

GLASS PASSIVATED SURFACE MOUNT BRIDGE RECTIFIERS

Features

- ◆ Glass Passivated Chip Junction
- ◆ Reverse Voltage - 100 to 1000 V
- ◆ Forward Current- 4 A
- ◆ High Surge Current Capability
- Designed for Surface Mount Application

UMSB

ROHS
COMPLIANT

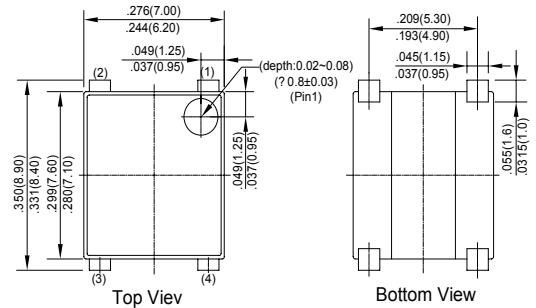

Mechanical Data

Case: JEDEC UMSB molded plastic body
 Terminals: Solderable per MIL-STD-750, Method 2026A
 Polarity: Polarity symbol marking on body
 Mounting Position: Any
 Weight: 0.00825 ounce, 0.234 grams

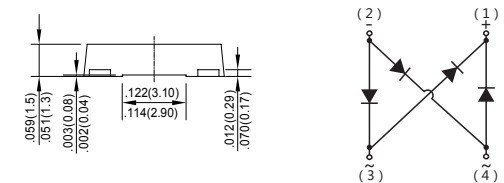

Dimensions in inches and (millimeters)

Maximum Ratings And Electrical Characteristics

Ratings at 25°C ambient temperature unless otherwise specified.

Single phase half-wave 60Hz, resistive or inductive load, for capacitive load current derate by 20%.

Parameter	Symbols	MSB40D	MSB40G	MSB40J	MSB40K	MSB40M	Units
		MDD MSB40D	MDD MSB40G	MDD MSB40J	MDD MSB40K	MDD MSB40M	
Maximum Repetitive Peak Reverse Voltage	V_{RRM}	200	400	600	800	1000	V
Maximum RMS voltage	V_{RMS}	140	280	420	560	700	V
Maximum DC Blocking Voltage	V_{DC}	200	400	600	800	1000	V
Maximum Average Forward Rectified Current	$I_{F(AV)}$	4					A
Peak Forward Surge Current 8.3 ms Single Half Sine Wave Superimposed on Rated Load (JEDEC Method)	I_{FSM}	95					A
Maximum Forward Voltage at 4.0 A	V_F	1.1					V
Maximum DC Reverse Current @ $T_a=25^\circ\text{C}$ at Rated DC Blocking Voltage @ $T_a=125^\circ\text{C}$	I_R	5 100					μA
Typical Junction Capacitance per element	C_j	40					pF
Operating and Storage Temperature Range	T_j, T_{stg}	-55 ~ +150					$^\circ\text{C}$

Note: 1. Measured at 1MHz and applied reverse voltage of 4 V D.C.

2. P.C.B. mounted with 4×1.5"×1.5" (3.81×3.81 cm) copper pad areas.



Typical Characteristics

Fig.1 Average Rectified Output Current Derating Curve

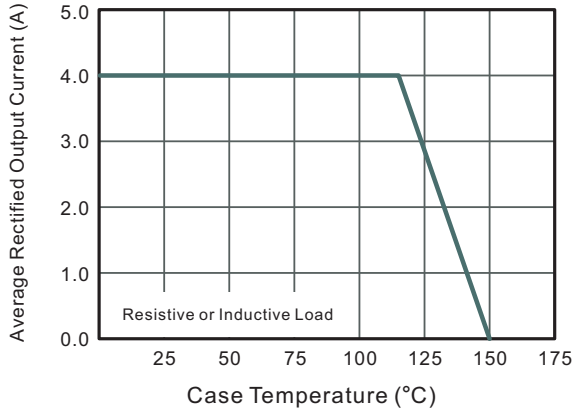

Fig.2 Typical Reverse Characteristics

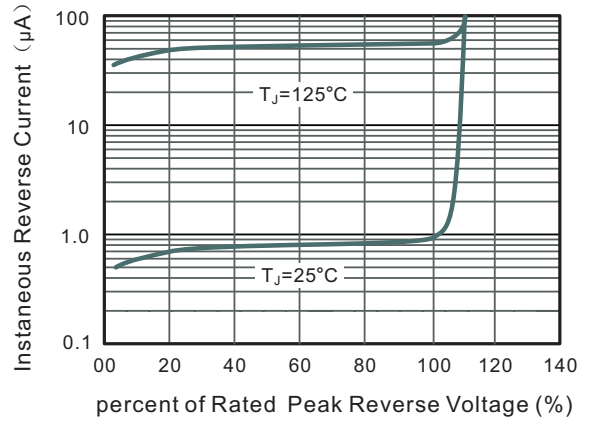

Fig.3 Typical Instantaneous Forward Characteristics

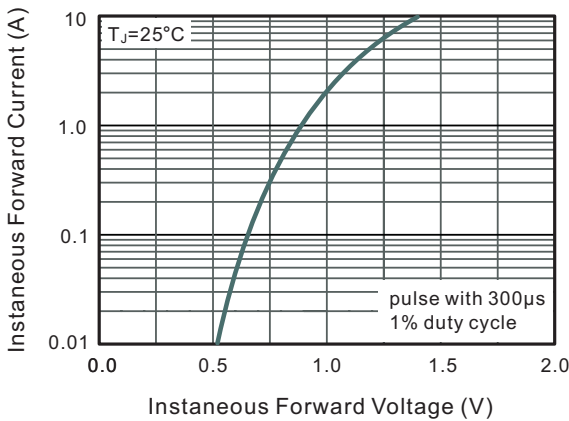

Fig.4 Typical Junction Capacitance

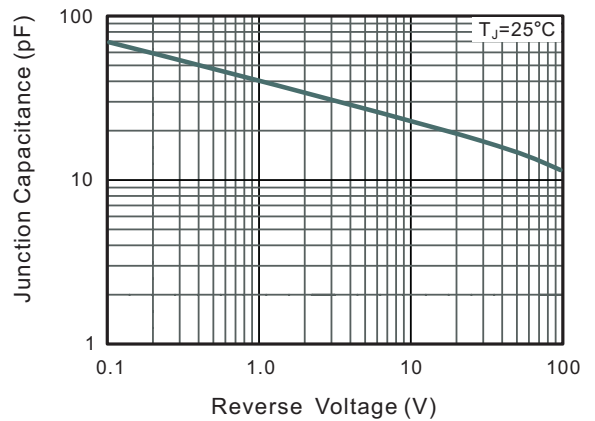
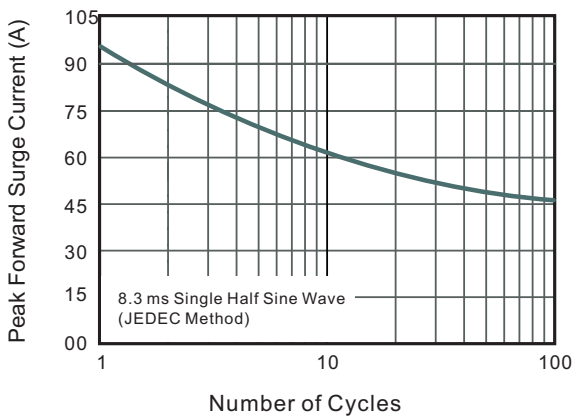

Fig.5 Maximum Non-Repetitive Peak Forward Surge Current



The curve above is for reference only.