

QUAD DIFFERENTIAL COMPARATOR

 Check for Samples: [LM139-SP](#), [LM139A-SP](#)

FEATURES

- QML-V Qualified, SMD 5962-7700801VCA, 5962-9673802VCA and 5962-9673802V9B
- Rad-Tolerant: 40 kRad/sec (Si) TID (5962-9673802VCA and 5962-9673802V9B) ⁽¹⁾
 - TID Dose Rate = 0.01 rad/sec (Si)
- Wide Supply Ranges
 - Single Supply: 2 V to 36 V (Tested to 30 V)
 - Dual Supplies: ±1 V to ±18 V (Tested to ±15 V)
- Low Supply-Current Drain Independent of Supply Voltage: 0.8 mA (Typ)
- Low Input Bias Current: 25 nA (Typ)
- Low Input Offset Current: 3 nA (Typ) (LM139)
- Low Input Offset Voltage: 2 mV (Typ)

- Common-Mode Input Voltage Range Includes Ground
- Differential Input Voltage Range Equal to Maximum-Rated Supply Voltage: ±36 V
- Low Output Saturation Voltage
- Output Compatible With TTL, MOS, and CMOS

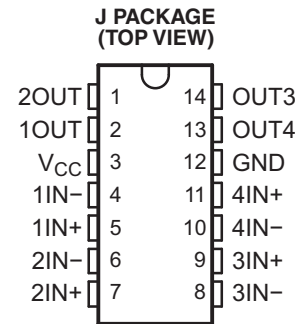

(1) Radiation tolerance is a typical value based upon initial device qualification with dose rate = 0.01 rad/sec. Radiation lot acceptance testing is available - contact factory for details.

DESCRIPTION/ORDERING INFORMATION

These devices consist of four independent voltage comparators that are designed to operate from a single power supply over a wide range of voltages. Operation from dual supplies also is possible, as long as the difference between the two supplies is 2 V to 36 V, and V_{CC} is at least 1.5 V more positive than the input common-mode voltage. Current drain is independent of the supply voltage. The outputs can be connected to other open-collector outputs to achieve wired-AND relationships.

The LM139 and LM139A are characterized for operation over the full military temperature range of -55°C to 125°C .

Table 1. ORDERING INFORMATION ⁽¹⁾

T_A	V_{IOmax} AT 25°C	MAX V_{CC}	PACKAGE ⁽²⁾	ORDERABLE PART NUMBER		TOP-SIDE MARKING
-55°C to 125°C	5 mV	30 V	J	LM139	5962-7700801VCA	5962-7700801VCA
	2 mV	30 V		LM139A	5962-9673802VCA ⁽³⁾	5962-9673802VCA
	2 mV	30 V	KGD	5962-9673802V9B ⁽³⁾		N/A

- (1) For the most current package and ordering information, see the Package Option Addendum at the end of this document, or see the TI web site at www.ti.com.
- (2) Package drawings, thermal data, and symbolization are available at www.ti.com/packaging.
- (3) Radiation tolerant



Please be aware that an important notice concerning availability, standard warranty, and use in critical applications of Texas Instruments semiconductor products and disclaimers thereto appears at the end of this data sheet.

BARE DIE INFORMATION

DIE THICKNESS	BACKSIDE FINISH	BACKSIDE POTENTIAL	BON PAD METALLIZATION COMPOSITION	BOND PAD THICKNESS
15 mils	Silicon with backgrind	Floating	AlCu (0.5%)	0.055 mils

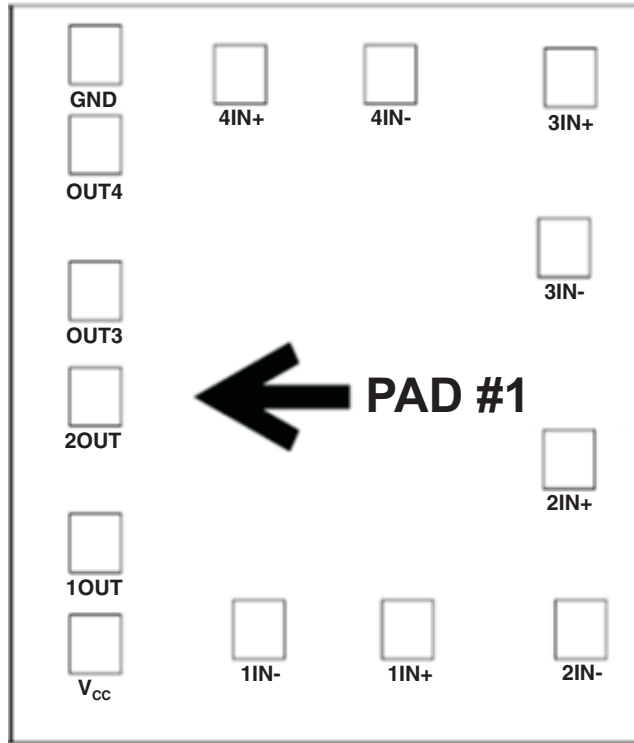
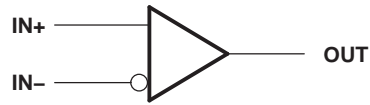

Table 2. Bond Pad Coordinates in Microns

DISCRIPTION	PAD NUMBER	Xmin	Ymin	Xmax	Ymax
2OUT	1	22.86	455.93	124.46	557.53
1OUT	2	22.86	203.2	124.46	304.8
Vcc	3	22.86	27.94	124.46	129.54
1IN-	4	345.44	53.34	447.04	154.94
1IN+	5	640.08	53.34	741.68	154.94
2IN-	6	981.71	53.34	1083.31	154.94
2IN+	7	958.85	347.98	1060.45	449.58
3IN-	8	948.69	713.74	1050.29	815.34
3IN+	9	961.39	1008.38	1062.99	1109.98
4IN-	10	605.79	1013.46	707.39	1115.06
4IN+	11	308.61	1013.46	410.21	1115.06
GND	12	22.86	1047.75	124.46	1149.35
OUT4	13	22.86	891.54	124.46	993.14
OUT3	14	22.86	638.81	124.46	740.41

SYMBOL (EACH COMPARATOR)



SCHEMATIC (EACH COMPARATOR)

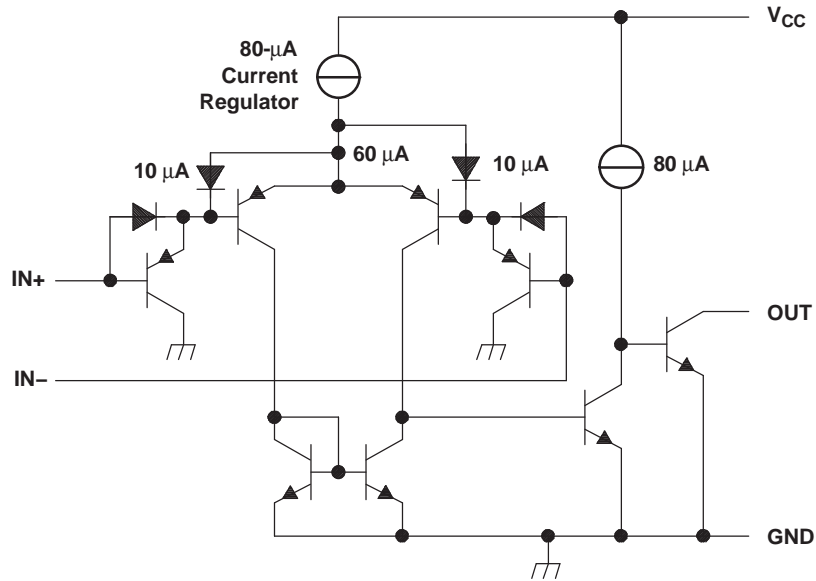

All current values shown are nominal.

ABSOLUTE MAXIMUM RATINGS⁽¹⁾

over operating free-air temperature range (unless otherwise noted)

			MIN	MAX	UNIT
V _{CC}	Supply voltage ⁽²⁾			36	V
V _{ID}	Differential input voltage ⁽³⁾			±36	V
V _I	Input voltage range (either input)		-0.3	36	V
V _O	Output voltage			36	V
I _O	Output current			20	mA
	Duration of output short circuit to ground ⁽⁴⁾			Unlimited	
θ _{JC}	Package thermal impedance, junction to case ^{(5) (6)}	J package		15.05	°C/W
T _J	Operating virtual-junction temperature			150	°C
	Lead temperature 1,6 mm (1/16 in) from case for 60 s	J package		300	°C
T _{stg}	Storage temperature range		-65	150	°C

- (1) Stresses beyond those listed under "absolute maximum ratings" may cause permanent damage to the device. These are stress ratings only, and functional operation of the device at these or any other conditions beyond those indicated under "recommended operating conditions" is not implied. Exposure to absolute-maximum-rated conditions for extended periods may affect device reliability.
- (2) All voltage values, except differential voltages, are with respect to network ground.
- (3) Differential voltages are at IN+ with respect to IN-.
- (4) Short circuits from outputs to V_{CC} can cause excessive heating and eventual destruction.
- (5) Maximum power dissipation is a function of T_J (max), θ_{JC}, and T_C. The maximum allowable power dissipation at any allowable case temperature is $P_D = (T_J(\text{max}) - T_C)/\theta_{JC}$. Operating at the absolute maximum T_J of 150°C can affect reliability.
- (6) The package thermal impedance is calculated in accordance with MIL-STD-883.

ELECTRICAL CHARACTERISTICS FOR LM139

 at specified free-air temperature, $V_{CC} = 5\text{ V}$ (unless otherwise noted)

PARAMETER		TEST CONDITIONS ⁽¹⁾		T_A ⁽²⁾	MIN	TYP	MAX	UNIT
V_{IO}	Input offset voltage	$V_{CC} = 5\text{ V to }30\text{ V}$, $V_{IC} = V_{ICR\text{ min}}$, $V_O = 1.4\text{ V}$		25°C	1			mV
				Full range	4			
I_{IO}	Input offset current	$V_O = 1.4\text{ V}$		25°C	3	25		nA
				Full range	100			
I_{IB}	Input bias current	$V_O = 1.4\text{ V}$		25°C	-25	-100		nA
				Full range	-300			
V_{ICR}	Common-mode input-voltage range ⁽³⁾			25°C	0 to $V_{CC} - 1.5$			V
				Full range	0 to $V_{CC} - 2$			
A_{VD}	Large-signal differential-voltage amplification	$V_{CC+} = \pm 7.5\text{ V}$, $V_O = -5\text{ V to }5\text{ V}$		25°C	50	200		V/mV
I_{OH}	High-level output current	$V_{ID} = 1\text{ V}$	$V_{OH} = 5\text{ V}$	25°C	0.1			nA
			$V_{OH} = 30\text{ V}$	Full range	1			μA
V_{OL}	Low-level output voltage	$V_{ID} = -1\text{ V}$, $I_{OL} = 4\text{ mA}$		25°C	150	400		mV
				Full range	700			
I_{OL}	Low-level output current	$V_{ID} = -1\text{ V}$, $V_{OL} = 1.5\text{ V}$		25°C	6	16		mA
I_{CC}	Supply current (four comparators)	$V_O = 2.5\text{ V}$, No load		25°C	0.8		2	mA

- (1) All characteristics are measured with zero common-mode input voltage, unless otherwise specified.
- (2) Full range (MIN to MAX) for LM139 and LM139A is -55°C to 125°C . All characteristics are measured with zero common-mode input voltage, unless otherwise specified.
- (3) The voltage at either input or common-mode should not be allowed to go negative by more than 0.3 V. The upper end of the common-mode voltage range is $V_{CC+} - 1.5\text{ V}$; however, one input can exceed V_{CC+} , and the comparator will provide a proper output state as long as the other input remains in the common-mode range. Either or both inputs can go to 30 V without damage.

ELECTRICAL CHARACTERISTICS FOR LM139Aat specified free-air temperature, $V_{CC} = 5\text{ V}$ (unless otherwise noted)

PARAMETER		TEST CONDITIONS ⁽¹⁾	T_A ⁽²⁾	MIN	TYP ⁽³⁾	MAX	UNIT
I_{CC}	Supply current	$R_L = \infty$, $V_+ = 30\text{ V}$	Full range			2	mA
I_{CEX}	Output leakage current	$V_+ = 30\text{ V}$, $V_{OUT} = 30\text{ V}$	Full range			1	μA
V_{SAT}	Saturation voltage	$I_{SINK} = 4\text{ mA}$	25°C			400	mV
			Full range			700	
I_{SINK}	Output sink current	$V_{OUT} = 1.5\text{ V}$	25°C		6		mA
V_{IO}	Input offset voltage	$V_+ = 5\text{ V}$, $V_{CM} = 0\text{ V}$	25°C			± 2	mV
			Full range			± 4	
		$V_+ = 30\text{ V}$, $V_{CM} = 0\text{ V}$	25°C			± 2	mV
			Full range			± 4	
		$V_+ = 30\text{ V}$, $V_{CM} = 28.5\text{ V}$, $V_{OUT} = 1.5\text{ V}$	25°C			± 2	mV
$V_+ = 30\text{ V}$, $V_{CM} = 28\text{ V}$, $V_{OUT} = 1.5\text{ V}$	Full range			± 4	mV		
I_{IB}	Input bias current	$V_{OUT} = 1.5\text{ V}$	25°C	-100		-1	nA
			Full range	-300		-1	
I_{IO}	Input offset current	$V_{OUT} = 1.5\text{ V}$	25°C			± 25	nA
			Full range			± 100	
PSRR	Power supply rejection ratio	$V_+ = 5\text{ V}$ to 30 V	25°C	60		100	dB
CMRR	Common-mode rejection ratio	$V_+ = 30\text{ V}$, $V_{CM} = 0\text{ V}$ to 28.5 V	25°C	60			dB
A_V	Voltage gain	$V_+ = 15\text{ V}$, $R_L \geq 15\text{ k}\Omega$, $V_{OUT} = 1\text{ V}$ to 11 V	25°C	50			V/mV
V_{CM} ⁽⁴⁾	Common mode voltage range	$V_+ = 30\text{ V}$	25°C	0		$V_+ - 1.5$	V
			Full range	0		$V_+ - 2$	
V_{DIFF} ⁽⁵⁾	Differential input voltage	$V_+ = 30\text{ V}$, $V_- = 0\text{ V}$, $V_{IN+} = 36\text{ V}$, $V_{IN-} = 0\text{ V}$	Full range			500	nA
		$V_+ = 30\text{ V}$, $V_- = 0\text{ V}$, $V_{IN+} = 0\text{ V}$, $V_{IN-} = 36\text{ V}$				500	
t_{RLH}	Response time	V_{OD} (overdrive) = 5 mV	25°C			5	μs
		V_{OD} (overdrive) = 50 mV				0.8	
t_{RHL}	Response time	V_{OD} (overdrive) = 5 mV	25°C			2.5	μs
		V_{OD} (overdrive) = 50 mV				0.8	

- (1) All characteristics are measured under open-loop conditions, with zero common-mode input voltage, unless otherwise specified. MAX V_{CC} for testing purposes is 30 V.
- (2) Full range is -55°C to 125°C for LM139A.
- (3) All typical values are at $T_A = 25^\circ\text{C}$.
- (4) The input common mode voltage or either input signal voltage should not be allowed to go negative by more than 0.3 V. The upper end of the common mode voltage range is $V_+ - 1.5\text{ V}$ for $T_A = 25^\circ\text{C}$ or $V_+ - 2.0\text{ V}$ for $T_A = \text{Full range}$, but either or both inputs can go to +30 V dc without damage independent of the magnitude of V_+ .
- (5) Positive excursions of input voltage may exceed the power supply level. As long as the other voltage remains within the common mode range, the comparator will provide a proper output state. The low input voltage state must not be less than -0.3 V dc or 0.3 V dc below the magnitude of the negative power supply, if used.

SWITCHING CHARACTERISTICS

 $V_{CC} = 5\text{ V}$, $T_A = 25^\circ\text{C}$

PARAMETER	TEST CONDITIONS	TYP	UNIT
Response time	R_L connected to 5 V through 5.1 k Ω , $C_L = 15\text{ pF}^{(1)}\text{ }^{(2)}$	100-mV input step with 5-mV overdrive	1.3
		TTL-level input step	0.3

(1) C_L includes probe and jig capacitance.

(2) The response time specified is the interval between the input step function and the instant when the output crosses 1.4 V.

TYPICAL CHARACTERISTICS

SUPPLY CURRENT
vs
SUPPLY VOLTAGE

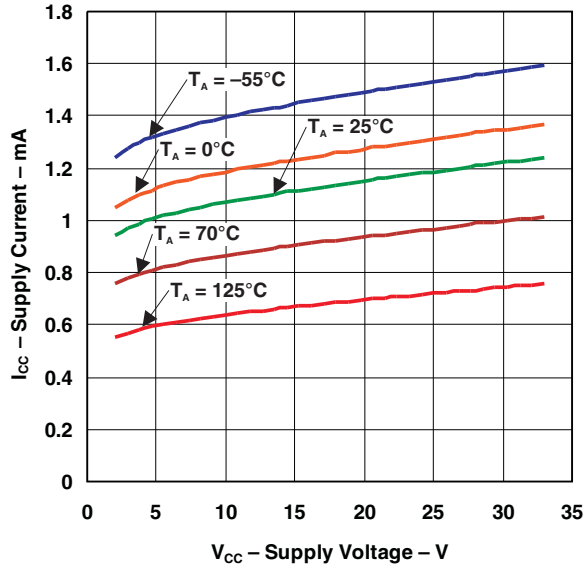

INPUT BIAS CURRENT
vs
SUPPLY VOLTAGE

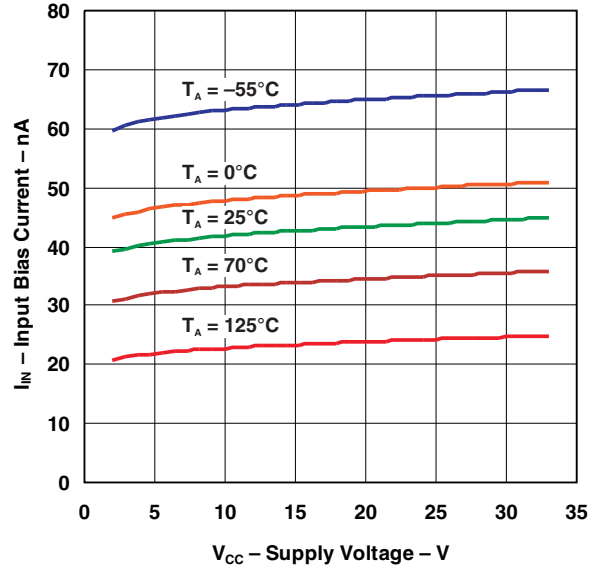

OUTPUT SATURATION VOLTAGE

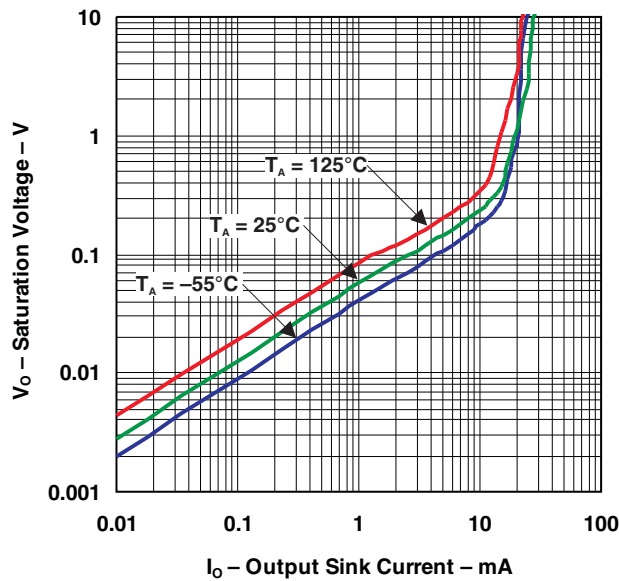

TYPICAL CHARACTERISTICS (continued)

RESPONSE TIME FOR VARIOUS OVERDRIVES
NEGATIVE TRANSITION

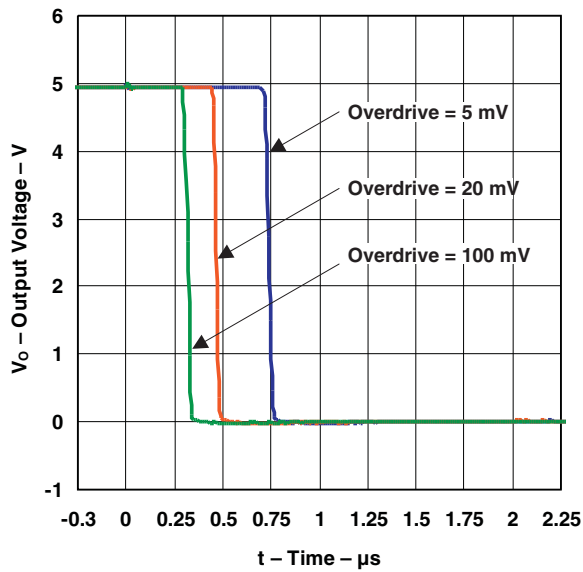

RESPONSE TIME FOR VARIOUS OVERDRIVES
POSITIVE TRANSITION

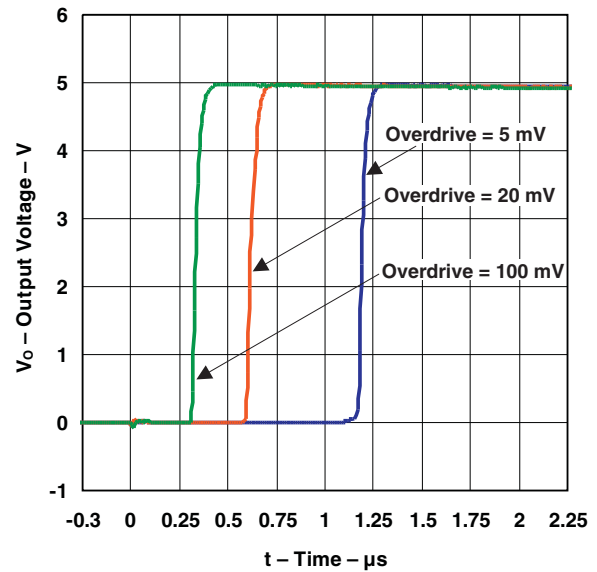

PACKAGING INFORMATION

Orderable Device	Status ⁽¹⁾	Package Type	Package Drawing	Pins	Package Qty	Eco Plan ⁽²⁾	Lead/ Ball Finish	MSL Peak Temp ⁽³⁾	Samples (Requires Login)
5962-7700801VCA	ACTIVE	CDIP	J	14	1	TBD	A42	N / A for Pkg Type	
5962-9673802V9B	ACTIVE	XCEPT	KGD	0	100	TBD	Call TI	N / A for Pkg Type	
5962-9673802VCA	ACTIVE	CDIP	J	14	1	TBD	A42	N / A for Pkg Type	

⁽¹⁾ The marketing status values are defined as follows:

ACTIVE: Product device recommended for new designs.

LIFEBUY: TI has announced that the device will be discontinued, and a lifetime-buy period is in effect.

NRND: Not recommended for new designs. Device is in production to support existing customers, but TI does not recommend using this part in a new design.

PREVIEW: Device has been announced but is not in production. Samples may or may not be available.

OBSELETE: TI has discontinued the production of the device.

⁽²⁾ Eco Plan - The planned eco-friendly classification: Pb-Free (RoHS), Pb-Free (RoHS Exempt), or Green (RoHS & no Sb/Br) - please check <http://www.ti.com/productcontent> for the latest availability information and additional product content details.

TBD: The Pb-Free/Green conversion plan has not been defined.

Pb-Free (RoHS): TI's terms "Lead-Free" or "Pb-Free" mean semiconductor products that are compatible with the current RoHS requirements for all 6 substances, including the requirement that lead not exceed 0.1% by weight in homogeneous materials. Where designed to be soldered at high temperatures, TI Pb-Free products are suitable for use in specified lead-free processes.

Pb-Free (RoHS Exempt): This component has a RoHS exemption for either 1) lead-based flip-chip solder bumps used between the die and package, or 2) lead-based die adhesive used between the die and leadframe. The component is otherwise considered Pb-Free (RoHS compatible) as defined above.

Green (RoHS & no Sb/Br): TI defines "Green" to mean Pb-Free (RoHS compatible), and free of Bromine (Br) and Antimony (Sb) based flame retardants (Br or Sb do not exceed 0.1% by weight in homogeneous material)

⁽³⁾ MSL, Peak Temp. -- The Moisture Sensitivity Level rating according to the JEDEC industry standard classifications, and peak solder temperature.

Important Information and Disclaimer: The information provided on this page represents TI's knowledge and belief as of the date that it is provided. TI bases its knowledge and belief on information provided by third parties, and makes no representation or warranty as to the accuracy of such information. Efforts are underway to better integrate information from third parties. TI has taken and continues to take reasonable steps to provide representative and accurate information but may not have conducted destructive testing or chemical analysis on incoming materials and chemicals. TI and TI suppliers consider certain information to be proprietary, and thus CAS numbers and other limited information may not be available for release.

In no event shall TI's liability arising out of such information exceed the total purchase price of the TI part(s) at issue in this document sold by TI to Customer on an annual basis.

OTHER QUALIFIED VERSIONS OF LM139-SP :

- Catalog: [LM139](#)

NOTE: Qualified Version Definitions:

- Catalog - TI's standard catalog product

IMPORTANT NOTICE

Texas Instruments Incorporated and its subsidiaries (TI) reserve the right to make corrections, enhancements, improvements and other changes to its semiconductor products and services per JESD46, latest issue, and to discontinue any product or service per JESD48, latest issue. Buyers should obtain the latest relevant information before placing orders and should verify that such information is current and complete. All semiconductor products (also referred to herein as "components") are sold subject to TI's terms and conditions of sale supplied at the time of order acknowledgment.

TI warrants performance of its components to the specifications applicable at the time of sale, in accordance with the warranty in TI's terms and conditions of sale of semiconductor products. Testing and other quality control techniques are used to the extent TI deems necessary to support this warranty. Except where mandated by applicable law, testing of all parameters of each component is not necessarily performed.

TI assumes no liability for applications assistance or the design of Buyers' products. Buyers are responsible for their products and applications using TI components. To minimize the risks associated with Buyers' products and applications, Buyers should provide adequate design and operating safeguards.

TI does not warrant or represent that any license, either express or implied, is granted under any patent right, copyright, mask work right, or other intellectual property right relating to any combination, machine, or process in which TI components or services are used. Information published by TI regarding third-party products or services does not constitute a license to use such products or services or a warranty or endorsement thereof. Use of such information may require a license from a third party under the patents or other intellectual property of the third party, or a license from TI under the patents or other intellectual property of TI.

Reproduction of significant portions of TI information in TI data books or data sheets is permissible only if reproduction is without alteration and is accompanied by all associated warranties, conditions, limitations, and notices. TI is not responsible or liable for such altered documentation. Information of third parties may be subject to additional restrictions.

Resale of TI components or services with statements different from or beyond the parameters stated by TI for that component or service voids all express and any implied warranties for the associated TI component or service and is an unfair and deceptive business practice. TI is not responsible or liable for any such statements.

Buyer acknowledges and agrees that it is solely responsible for compliance with all legal, regulatory and safety-related requirements concerning its products, and any use of TI components in its applications, notwithstanding any applications-related information or support that may be provided by TI. Buyer represents and agrees that it has all the necessary expertise to create and implement safeguards which anticipate dangerous consequences of failures, monitor failures and their consequences, lessen the likelihood of failures that might cause harm and take appropriate remedial actions. Buyer will fully indemnify TI and its representatives against any damages arising out of the use of any TI components in safety-critical applications.

In some cases, TI components may be promoted specifically to facilitate safety-related applications. With such components, TI's goal is to help enable customers to design and create their own end-product solutions that meet applicable functional safety standards and requirements. Nonetheless, such components are subject to these terms.

No TI components are authorized for use in FDA Class III (or similar life-critical medical equipment) unless authorized officers of the parties have executed a special agreement specifically governing such use.

Only those TI components which TI has specifically designated as military grade or "enhanced plastic" are designed and intended for use in military/aerospace applications or environments. Buyer acknowledges and agrees that any military or aerospace use of TI components which have **not** been so designated is solely at the Buyer's risk, and that Buyer is solely responsible for compliance with all legal and regulatory requirements in connection with such use.

TI has specifically designated certain components which meet ISO/TS16949 requirements, mainly for automotive use. Components which have not been so designated are neither designed nor intended for automotive use; and TI will not be responsible for any failure of such components to meet such requirements.

Products

Audio	www.ti.com/audio
Amplifiers	amplifier.ti.com
Data Converters	dataconverter.ti.com
DLP® Products	www.dlp.com
DSP	dsp.ti.com
Clocks and Timers	www.ti.com/clocks
Interface	interface.ti.com
Logic	logic.ti.com
Power Mgmt	power.ti.com
Microcontrollers	microcontroller.ti.com
RFID	www.ti-rfid.com
OMAP Applications Processors	www.ti.com/omap
Wireless Connectivity	www.ti.com/wirelessconnectivity

Applications

Automotive and Transportation	www.ti.com/automotive
Communications and Telecom	www.ti.com/communications
Computers and Peripherals	www.ti.com/computers
Consumer Electronics	www.ti.com/consumer-apps
Energy and Lighting	www.ti.com/energy
Industrial	www.ti.com/industrial
Medical	www.ti.com/medical
Security	www.ti.com/security
Space, Avionics and Defense	www.ti.com/space-avionics-defense
Video and Imaging	www.ti.com/video

TI E2E Community

e2e.ti.com

Mouser Electronics

Authorized Distributor

Click to View Pricing, Inventory, Delivery & Lifecycle Information:

[Texas Instruments:](#)

[5962-9673802V9B](#)