

Final Control Elements

POSITIONER BACKUP STATION

(with bargraph/digital indicator)

Functions & Features

- Bargraph indicator
- Digital display indicating PV/CAS/MV selectable
- External contact closure to switch operation modes
- Valve positioner incorporated
- Re-transmitted outputs available for valve position and manual status
- Potentiometer, voltage or current input for setpoint
- DIN size

Typical Applications

- Computer and DCS backup applications
- Controlling electric valves from a computer
- Manual damper position control
- Remote manual control of electric valves

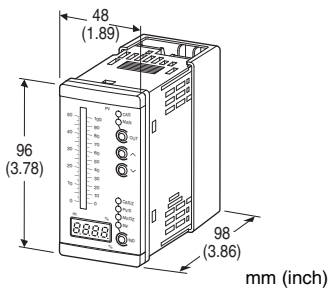

MODEL: ABM2-[1][2][3][4]-[5][6]

ORDERING INFORMATION

- Code number: ABM2-[1][2][3][4]-[5][6]
- Specify a code from below for each of [1] through [6]. (e.g. ABM2-RAAA1-M2/Q)
- Specify the specification for option code /Q (e.g. /C01/S01)
- Scale (Refer to 'SCALE PLATE' section for details on the scale.)

[1] BAR LED COLOR

- R: Red
- Y: Amber
- G: Green
- B: Blue

[2] CAS INPUT (CAS)

Current

A: 4 - 20 mA DC (Input resistance 250 Ω)

Voltage

6: 1 - 5 V DC (Input resistance 1 MΩ min.)

4W: -10 - +10 V DC (Input resistance 1 MΩ min.)

5W: -5 - +5 V DC (Input resistance 1 MΩ min.)

[3] POSITION SETPOINT INPUT (PV)

Current

A: 4 - 20 mA DC (Input resistance 250 Ω)

Voltage

6: 1 - 5 V DC (Input resistance 1 MΩ min.)

Potentiometer

R: Total resistance 100 Ω - 10 kΩ

[4] RE-TRANSMITTED OUTPUT (MV)

Current

A1: 4 - 20 mA DC (Load resistance 350 Ω max.)

output range -15 - +115 %

A2: 4 - 20 mA DC (Load resistance 350 Ω max.)

output range 0 - 100 %

Note: Select '/A2' to use with same output range as ABM.

[5] POWER INPUT

AC Power

M2: 100 - 240 V AC (Operational voltage range 85 - 264 V, 47 - 66 Hz)

DC Power

R: 24 V DC

(Operational voltage range 24 V ±10 %, ripple 10 %p-p max.)

[6] OPTIONS

blank: none

/Q: Options other than the above (specify the specification)

SPECIFICATIONS OF OPTION: Q (multiple selections)

COATING (For the detail, refer to M-System's web site.)

/C01: Silicone coating

/C02: Polyurethane coating

/C03: Rubber coating

TERMINAL SCREW MATERIAL

/S01: Stainless steel

SPARE PARTS

- Scale plate

GENERAL SPECIFICATIONS

Construction: Panel flush mounting

Degree of protection: IP65; applicable to the front panel for single unit mounted according to the specified panel cutout

Connection: M3 separable screw terminal (torque 0.6 N·m)

Solderless terminal: Refer to the drawing at the end of the section.

Recommended manufacturer: Japan Solderless Terminal MFG. Co., Ltd., Nichifu Co., Ltd.

(Solderless terminals with insulation sleeve do not fit.)

Applicable wire size: 0.25 to 1.65 mm²

Screw terminal: Nickel-plated steel (standard) or stainless steel

Housing material: Flame-resistant resin (gray)

■ BUTTONS

Manual output switching: With CAS (cascade) - MAN (manual) selector ('OUT'), it is available to switch between cascade control outputting to follow CAS input signal and manual operation.

MAN control button ▲▼: Change setting value. For MAN mode control positioning output.

Digital display selector (IND): Switches between CAS input, PV input, MV output, Version display, User Zero setting, User Span setting or Deadband.

■ FUNCTIONS

Manual status contact: Turns on when manual operation is available

Isolation: CAS input to PV input to MV output or remote output switch command to positioning output to MAN status output to power

■ SCALE PLATE: Flame resistant resin (replaceable at the front; white scale & characters on black base)

Scale: Max. 4 characters including decimal point and negative sign

- **Divisions:** Min. 21, max. 43.9
- **Engineering unit:** Max. 4 characters (Unit other than % also can be specified)

■ LEDs

CAS output LED: Red LED turns on in CAS mode.

MAN output LED: Red LED turns on in MAN mode.

CAS/Z LED: Red LED turns on, CAS input % indication with 7 segments LED.

Green LED turns on while user zero setting indicated with 7 segments LED.

PV/S LED: Red LED turns on, PV input % indication with 7 segments LED.

Green LED turns on while user span setting indicated with 7 segments LED.

MV/DZ LED: Red LED turns on (MAN mode is included), MV output % indication with 7 segments LED.

Green LED turns on while deadband value indicated with 7

segments LED.

IMF. LED: Red LED turns on, the firmware version indicated with 7 segments LED.

Green LED turns on but Not Used.

■ USER ZERO SETTING, USER SPAN SETTING

It is available to change Zero and Span of PV input.

- User Zero setting range: 0.0 to 49.9% (factory default: 0%)

- User Span setting range: 50.0 to 100.0% (factory default: 100%)

■ DEADBAND

Setting range: 1.0 to 10.0% (factory default: 1.0%)

Hysteresis: 0.5 % fixed

■ Recommended solderless terminal

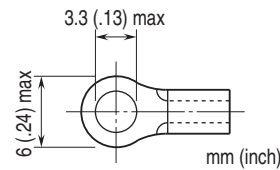

BARGRAPH/DIGITAL DISPLAY

■ BARGRAPH: PV input is shown.

LED: 55 segments, 55.5 mm (2.19") long, 3.0 mm (.12") wide. Display -4 to +104 % by 2 % step (for 0 %, 3 segments are on from bottom), for below -4 %, the bottom segment is on.

■ DIGITAL INDICATOR: CAS input, PV input, MV output (No scaling, display range: -15.0 to +115.0 %)

LED: 4 digits, red, 10 mm (.39") high, 24 mm (.94") wide

Decimal point position: One decimal places fixed

Scaling range: -15 to +115.0%

Zero indication: Higher-digit zeros are suppressed.

Over-range indication: 'Hi' is displayed when display exceeds scaled range.

Under-range indication: 'Lo' is displayed when display exceeds scaled range.

INPUT SPECIFICATIONS

■ CAS input

- **DC Current**

Input resistor incorporated

■ PV input

- **DC Current**

Input resistor incorporated

Min. span: ≥ 50% of input spec.

- **DC Voltage**

Min. span: ≥ 50% of input spec.

- **Potentiometer**

Total resistance: 100 Ω - 10 kΩ

Min span: ≥ 50% of total resistance

Reference voltage: 1 V DC

■ **Remote output switching:** External contact closure switches the ABM2 to MAN mode when the CAS-MAN selector is at CAS position (Not switched with MAN position. Refer to the table 1)

Sensing (open): Approx. 4.5 V DC

ON voltage: ≤ 1 V DC

ON resistance: ≤ 10 kΩ

OFF voltage: ≥ 2.6 V DC

OFF resistance: ≥ 49.9 kΩ

[Table 1]

REMOTE COMMAND	INDICATOR LED	
	CAS LED (RED)	MAN LED (RED)
ON	MAN Mode	MAN Mode
OFF	CAS Mode	MAN Mode

OUTPUT SPECIFICATIONS

MV output

Conformance range:

- **A1:** -15 to +115 %
- **A2:** 0 to 100 %

■ **Positioning Output:**

Rated load: 240 V AC or 30 V DC @ 1 A (resistive load)

For maximum relay life with inductive loads, external protection is recommended.

Mechanical life: 5 × 10⁷ cycles

Maximum switching voltage: 250 V AC or 125 V DC (0.2 A) (resistive load)

Maximum switching power: 250 VA or 30 W (DC) (resistive load)

■ **Manual status output:** Photo MOS relay

Rating: 240 V AC or 30 V DC @ 100 mA

ON resistance: 25 Ω

Permissible: 400 mW

INSTALLATION

Power consumption

• **AC:** (with max. load)

Approx. 4 VA at 100 V

Approx. 5.5 VA at 100 V

Approx. 6.5 VA at 264 V

• **DC:** Approx. 2 W

Operating temperature: -5 to +55°C (23 to 131°F)

Operating humidity: 10 to 90 %RH (non-condensing)

Mounting: Panel flush mounting

Weight: Approx. 300 g (0.66 lb)

PERFORMANCE in percentage of span

Accuracy: Input + output conversion accuracy

• **Input conversion accuracy:** ±0.2 %

• **Mv output accuracy:** ±0.5 %

Display accuracy:

• **Bargraph:** ±1 digit

• **Digital indicator:** ±1 digit

Temp. coefficient: ±0.015 %/°C (±0.008 %/°F)

Manual output resolution: 0.1 %

Response time: ≤ 0.5 sec. (0 - 90 %) between PV and MV

Line voltage effect: ±0.2 % over voltage range

Insulation resistance: ≥ 100 MΩ with 500 V DC

Dielectric strength: 1500 V AC @ 1 minute

(CAS input to PV input to MV output or remote output switch command to positioning output to MAN status output to power to ground)

STANDARDS & APPROVALS

EU conformity:

EMC Directive

EMI EN 61000-6-4

EMS EN 61000-6-2

Low Voltage Directive

EN 61010-1

Measurement Category II (positioning output, manual status output)

Installation Category II

Pollution degree 2

Remote output switch command or CAS input or PV input to positioning output or power: Reinforced insulation (300 V)

Positioning output to MV output to power: Reinforced insulation (300 V)

RoHS Directive

SCALE PLATE

■ WHAT MUST BE SPECIFIED WHEN ORDERING

Following two methods can specify scale plate.

a) Using 'Scale Plate Designer'

Access 'Design Scale Plate' in the M-System web site (<http://www.m-system.co.jp/english>). Scale plate can be designed in this web site.

By function below, it can be easy to create standard design or original design.

[Design Automatically]

Entering Minimum, Maximum, and Unit allows to create automatically a scale plate. Maximum created scale division number is '43.9'.

[Specify Division Interval]

Division Interval can be specified according to the application.

[Specify Division Number]

It is available to create originally with scale division number, length of line, position, character size, font and detailed position.

After designing is completed, register code is issued. Place the order with this code.

Once scale plate is designed, it is recorded. The register code can be used any number of times.

b) Specifying scale range and display unit when placing the order

It is available to create by specifying scale range and display unit for right and left.

Regarding design of scale plate such as division number, length of division number line, and character font, they are same as above [Design Automatically], M-System designs them.

■ DESIGNING BY 'DESIGN AUTOMATICALLY'

How 'Design Automatically' creates scale design is described succinctly below.

■ TYPES OF DIVISIONS

Five (5) types of divisions are used depending upon the scale span, which determined by the following equation:

$$\text{Scale Span} = (\text{Max. range value} - \text{Min. range value}) \cdot 10^n$$

where n = integer (used to limit the calculated scale span to the minimum of 1.1, below 11.0.)

• Type 1: $1.1 \leq \text{Scale Span} < 1.3$

Number of divisions: 22 to 25.9

Scale: Starts at 0, increments in 0.02 / 0.2 / 2 / 20 / 200.

Min. and max. values are indicated.

4 digits including negative sign and decimal point.

Division lines: Long, Short, Medium, Short, Long
(4 division lines repeating)

• Type 2: $1.3 \leq \text{Scale Span} < 2.0$

Number of divisions: 26 to 39.9

Scale: Starts at 0, increments in 0.03 / 0.3 / 3 / 30 / 300.

Min. and max. values are indicated.

4 digits including negative sign and decimal point.

Division lines: Long, Short, Medium, Short, Medium, Short, Long
(6 divisions repeating)

Minimum Divisions	Maximum Divisions	Bipolar Scale
11 —	1.29 —	600 —
10 —	1.2 —	400 —
8 —	1.0 —	200 —
6 —	0.8 —	0 —
4 —	0.6 —	-200 —
2 —	0.4 —	-400 —
0 —	0.2 —	-600 —
0 —	0 —	-600 —

Minimum Divisions	Maximum Divisions	Bipolar Scale
130 —	1.99 —	0.8 —
120 —	1.8 —	0.6 —
90 —	1.5 —	0.3 —
60 —	1.2 —	0.0 —
30 —	0.9 —	-0.3 —
0 —	0.6 —	-0.6 —
0 —	0.3 —	-0.6 —
0 —	0.0 —	-0.8 —

- Type 3: 2.0 Scale Span < 2.6
Number of divisions: 32 to 41.9
Scale: Starts at 0, increments in 0.05 / 0.5 / 5 / 50 / 500.
Min. and max. values are indicated.
4 digits including negative sign and decimal point.
Division lines: Long, Short, Medium, Short, Medium,
Short, Medium, Short, Long
(8 divisions repeating)

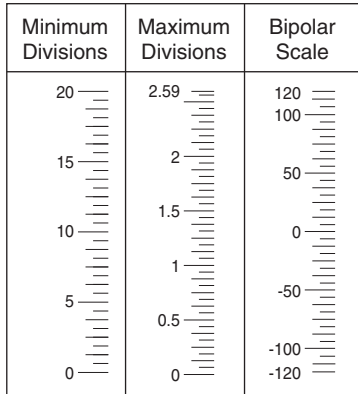

- Type 5: 5.5 Scale Span < 11.0
Number of divisions: 22 to 43.9
Scale: Starts at 0, increments in 0.01 / 0.1 / 1 / 10 / 100 / 1000.
Min. and max. values are indicated.
4 digits including negative sign and decimal point.
Division lines: Long, Medium, Medium, Medium, Long
(4 divisions repeating)

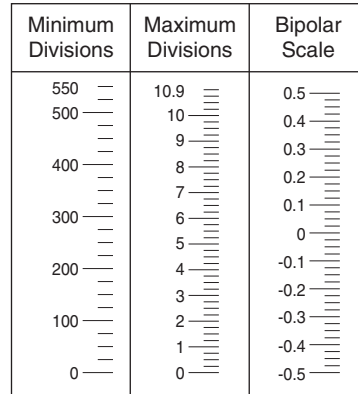

- Type 4: 2.6 Scale Span < 5.5
Number of divisions: 21 to 43.9
Scale: Starts at 0, increments in 0.05 / 0.5 / 5 / 50 / 500.
Min. and max. values are indicated.
4 digits including negative sign and decimal point.
Division lines: Long, Medium, Medium, Medium, Long
(4 divisions repeating)

[Example] : Bargraph range 0 to 260 cm (Type 4)
scale range: 0 – 260
scale unit (bargraph): cm

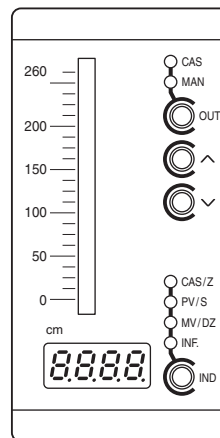
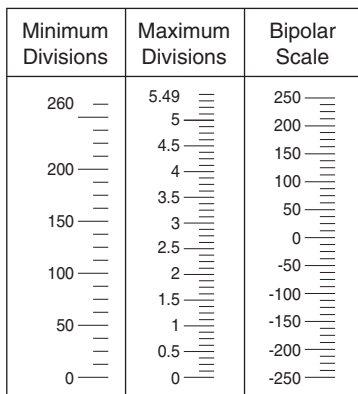

EXTERNAL VIEW

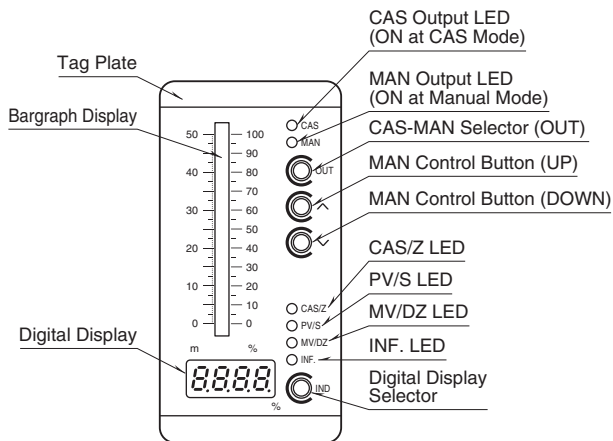

EXTERNAL DIMENSIONS & TERMINAL ASSIGNMENTS unit: mm (inch)

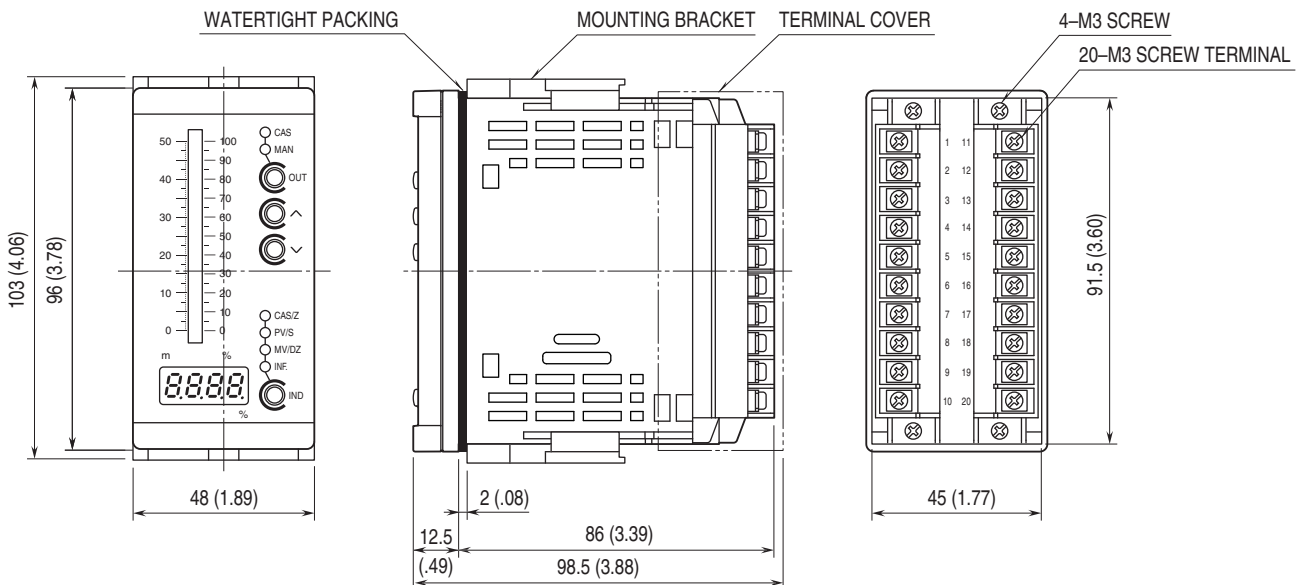

PANEL CUTOUT unit: mm

- Single Mounting
(Conform to degree of protection IP65)

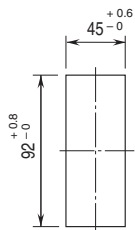

Panel thickness: 1.6 – 8.0 mm

- Clustered Mounting
(Not conform to degree of protection IP65)

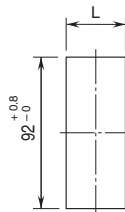

- When mounting, no extra space is needed between units.

Panel thickness: 1.6 – 8.0 mm

$$L = (45.5 + 48 \times (N - 1))_{-0.5}^{+0.5}$$

(N : number of units)

Note 1: Observe at the minimum of 3 cm above and below the units for heat dissipation.
Note 2: When replacing ABM, confirm that panel cutout size is the same as shown above.

SCHEMATIC CIRCUITRY & CONNECTION DIAGRAM

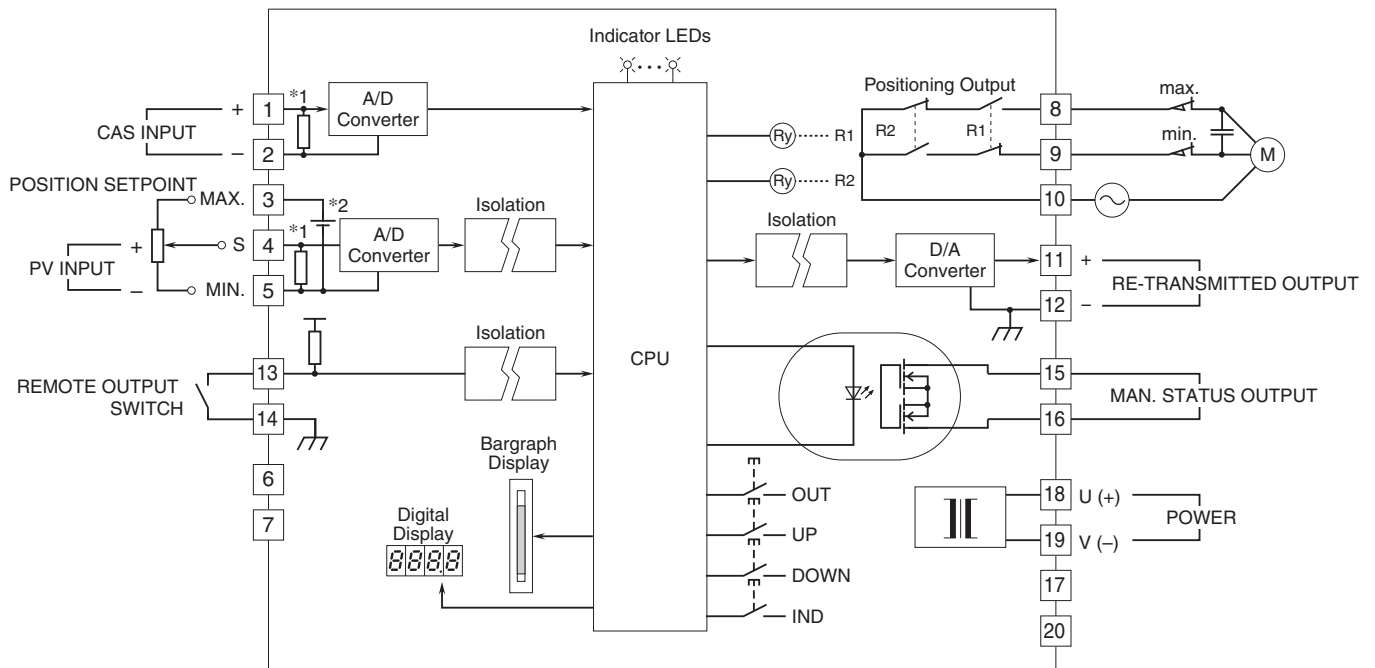

*1. Input shunt resistor incorporated for current input.
 *2. Excitation voltage generator incorporated for potentiometer input.



Specifications are subject to change without notice.