

# TLV225x-EP, TLV225xA-EP Advanced LinCMOS™ RAIL-TO-RAIL VERY-LOW-POWER OPERATIONAL AMPLIFIERS

SGLS217B – NOVEMBER 2003 – REVISED JUNE 2006

- **Controlled Baseline**
  - One Assembly/Test Site, One Fabrication Site
- **Extended Temperature Performance of –40°C to 125°C**
- **Enhanced Diminishing Manufacturing Sources (DMS) Support**
- **Enhanced Product-Change Notification**
- **Qualification Pedigree†**
- **ESD Protection Exceeds 2000 V Per MIL-STD-883, Method 3015; Exceeds 150 V (TLV2252/52A) and 100 V (TLV2254/54A) Using Machine Model (C = 200 pF, R = 0)**
- **Output Swing Includes Both Supply Rails**
- **Low Noise . . . 19 nV/√Hz Typ at f = 1 kHz**
- **Low Input Bias Current . . . 1 pA Typ**
- **Fully Specified for Both Single-Supply and Split-Supply Operation**
- **Very Low Power . . . 34 μA Per Channel (Typ)**
- **Common-Mode Input Voltage Range Includes Negative Rail**
- **Low Input Offset Voltage: 850 μV Max at T<sub>A</sub> = 25°C**
- **Wide Supply Voltage Range: 2.7 V to 16 V**
- **Macromodel Included**

† Component qualification in accordance with JEDEC and industry standards to ensure reliable operation over an extended temperature range. This includes, but is not limited to, Highly Accelerated Stress Test (HAST) or biased 85/85, temperature cycle, autoclave or unbiased HAST, electromigration, bond intermetallic life, and mold compound life. Such qualification testing should not be viewed as justifying use of this component beyond specified performance and environmental limits.

## description/ordering information

The TLV2252 and TLV2254 are dual and quadruple low-voltage operational amplifiers from Texas Instruments. Both devices exhibit rail-to-rail output performance for increased dynamic range in single- or split-supply applications. The TLV225x family consumes only 34 μA of supply current per channel. This micropower operation makes them good choices for battery-powered applications. This family is fully characterized at 3 V and 5 V and is optimized for low-voltage applications. The noise performance has been dramatically improved over previous generations of CMOS amplifiers. The TLV225x has a noise level of 19 nV/√Hz at 1kHz, four times lower than competitive micropower solutions.

The TLV225x, exhibiting high input impedance and low noise, are excellent for small-signal conditioning for high-impedance sources, such as piezoelectric transducers. Because of the micropower dissipation levels combined with 3-V operation, these devices work well in hand-held monitoring and remote-sensing applications. In addition, the rail-to-rail output feature with single or split supplies makes this family a great choice when interfacing with analog-to-digital converters (ADCs). For precision applications, the TLV225xA family is available and has a maximum input offset voltage of 850 μV.

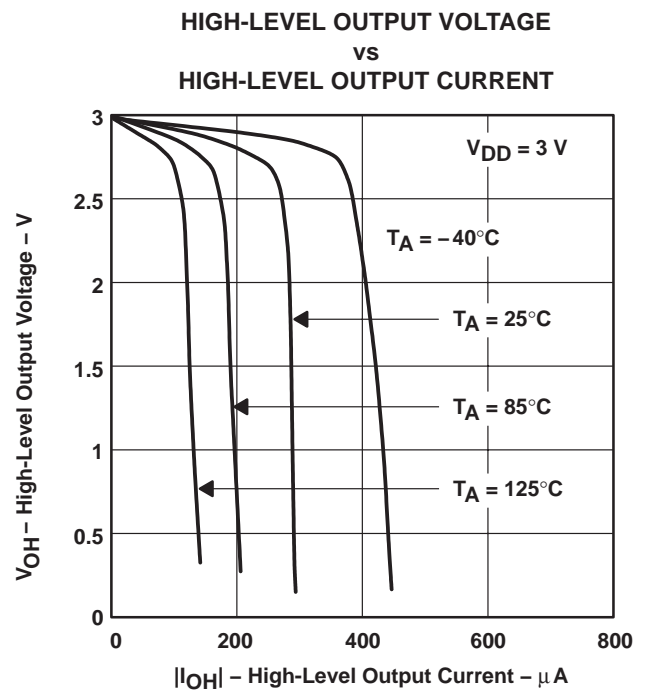

Figure 1



Please be aware that an important notice concerning availability, standard warranty, and use in critical applications of Texas Instruments semiconductor products and disclaimers thereto appears at the end of this data sheet.

Advanced LinCMOS is a trademark of Texas Instruments.

PRODUCTION DATA information is current as of publication date. Products conform to specifications per the terms of Texas Instruments standard warranty. Production processing does not necessarily include testing of all parameters.



POST OFFICE BOX 655303 • DALLAS, TEXAS 75265

Copyright © 2003 – 2006, Texas Instruments Incorporated

# TLV225x-EP, TLV225xA-EP

## Advanced LinCMOS™ RAIL-TO-RAIL

### VERY-LOW-POWER OPERATIONAL AMPLIFIERS

SGLS217B – NOVEMBER 2003 – REVISED JUNE 2006

#### description/ordering information (continued)

The TLV2252/2254 also make great upgrades to the TLV2322/2424 in standard designs. They offer increased output dynamic range, lower noise voltage, and lower input offset voltage. This enhanced feature set allows them to be used in a wider range of applications. For applications that require higher output drive and wider input voltage range, see the TLV2432 and TLV2442 devices. If your design requires single amplifiers, please see the TLV2211/21/31 family. These devices are single rail-to-rail operational amplifiers in the SOT-23 package. Small size and low power consumption make them ideal for high density, battery-powered equipment.

#### ORDERING INFORMATION

| T <sub>A</sub> | V <sub>IOMax</sub> AT 25°C | PACKAGE†   |               | ORDERABLE PART NUMBER | TOP-SIDE MARKING |
|----------------|----------------------------|------------|---------------|-----------------------|------------------|
| -40°C to 125°C | 850 μV                     | SOIC (D)   | Tape and reel | TLV2252AQDREP         | 2252AE           |
|                |                            | TSSOP (PW) | Tape and reel | TLV2252AQPWREP‡       |                  |
|                | 1500 μV                    | SOIC (D)   | Tape and reel | TLV2252QDREP          | 2252EP           |
|                |                            | TSSOP (PW) | Tape and reel | TLV2252QPWREP‡        |                  |
|                | 850 μV                     | SOIC (D)   | Tape and reel | TLV2254AQDREP         | TLV2254AEP       |
|                |                            | TSSOP (PW) | Tape and reel | TLV2254AQPWREP‡       |                  |
|                | 1500 μV                    | SOIC (D)   | Tape and reel | TLV2254QDREP          | TLV2254EP        |
|                |                            | TSSOP (PW) | Tape and reel | TLV2254QPWREP‡        |                  |

† Package drawings, standard packing quantities, thermal data, symbolization, and PCB design guidelines are available at [www.ti.com/sc/package](http://www.ti.com/sc/package).

#### Product preview

TLV2252, TLV2254A  
D OR PW PACKAGE  
(TOP VIEW)

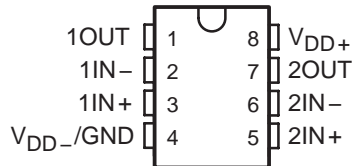

TLV2254, TLV2254A  
D PACKAGE  
(TOP VIEW)

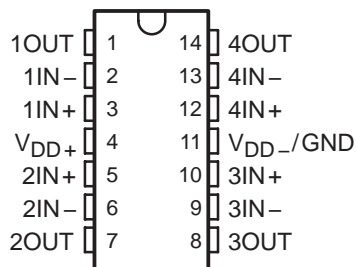

TLV2254, TLV2254A  
PW PACKAGE  
(TOP VIEW)

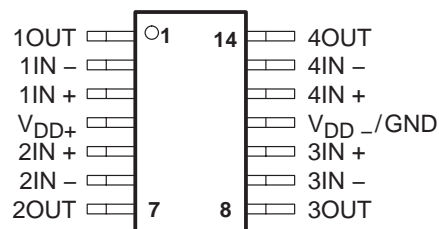

equivalent schematic (each amplifier)

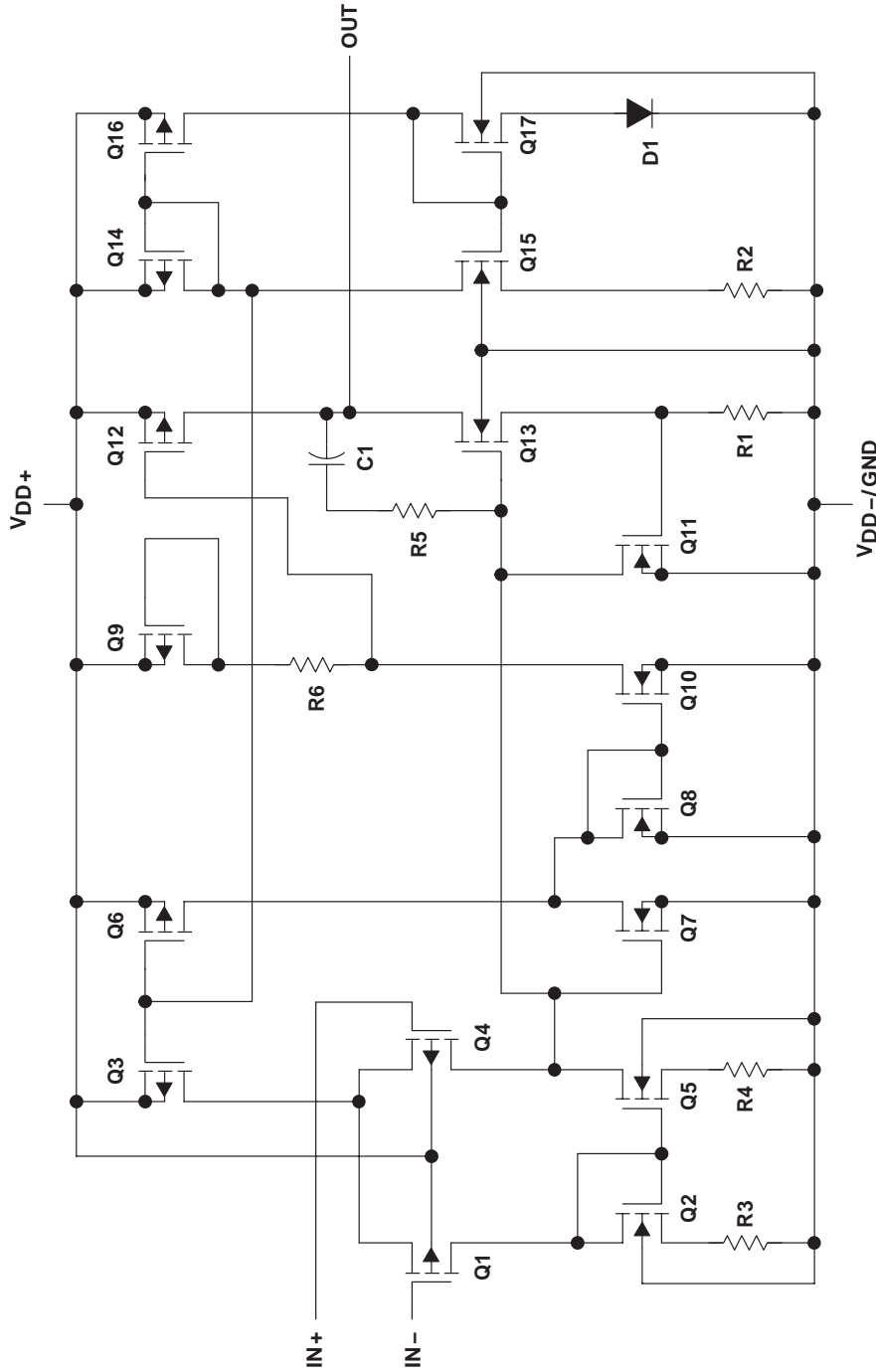

| ACTUAL DEVICE COMPONENT COUNT† |         |         |
|--------------------------------|---------|---------|
| COMPONENT                      | TLV2252 | TLV2254 |
| Transistors                    | 38      | 76      |
| Resistors                      | 30      | 56      |
| Diodes                         | 9       | 18      |
| Capacitors                     | 3       | 6       |

† Includes both amplifiers and all ESD, bias, and trim circuitry

**TLV225x-EP, TLV225xA-EP**  
**Advanced LinCMOS™ RAIL-TO-RAIL**  
**VERY LOW-POWER OPERATIONAL AMPLIFIERS**

SGLS217B – NOVEMBER 2003 – REVISED JUNE 2006

**absolute maximum ratings over operating free-air temperature range (unless otherwise noted)†**

|   |                                       |
|---|---------------------------------------|
| Supply voltage, $V_{DD}$ (see Note 1)                             | 16 V                                  |
| Differential input voltage, $V_{ID}$ (see Note 2)                 | $\pm V_{DD}$                          |
| Input voltage range, $V_I$ (any input, see Note 1)                | $V_{DD-} - 0.3\text{ V}$ to $V_{DD+}$ |
| Input current, $I_I$ (each input)                                 | $\pm 5\text{ mA}$                     |
| Output current, $I_O$   | $\pm 50\text{ mA}$                    |
| Total current into $V_{DD+}$                                      | $\pm 50\text{ mA}$                    |
| Total current out of $V_{DD-}$                                    | $\pm 50\text{ mA}$                    |
| Duration of short-circuit current (at or below 25°C) (see Note 3) | Unlimited                             |
| Continuous total power dissipation                                | See Dissipation Rating Table          |
| Operating free-air temperature range, $T_A$                       | -40°C to 125°C                        |
| Storage temperature range, $T_{stg}$                              | -65°C to 150°C                        |
| Lead temperature 1,6 mm (1/16 in) from case for 10 s              | 260°C                                 |

† Stresses beyond those listed under “absolute maximum ratings” may cause permanent damage to the device. These are stress ratings only, and functional operation of the device at these or any other conditions beyond those indicated under “recommended operating conditions” is not implied. Exposure to absolute-maximum-rated conditions for extended periods may affect device reliability.

- NOTES: 1. All voltage values, except differential voltages, are with respect to  $V_{DD-}$ .  
 2. Differential voltages are at the noninverting input with respect to the inverting input. Excessive current flows when input is brought below  $V_{DD-} - 0.3\text{ V}$ .  
 3. The output may be shorted to either supply. Temperature and/or supply voltages must be limited to ensure that the maximum dissipation rating is not exceeded.

**DISSIPATION RATING TABLE**

| PACKAGE | $T_A \leq 25^\circ\text{C}$<br>POWER RATING | DERATING FACTOR<br>ABOVE $T_A = 25^\circ\text{C}$ | $T_A = 85^\circ\text{C}$<br>POWER RATING | $T_A = 125^\circ\text{C}$<br>POWER RATING |
|---------|---|---|--|---|
| D-8     | 725 mW                                      | 5.8 mW/°C   | 377 mW                                   | 145 mW                                    |
| D-14    | 950 mW                                      | 7.6 mW/°C   | 494 mW                                   | 190 mW                                    |
| PW-8    | 525 mW                                      | 4.2 mW/°C   | 273 mW                                   | 105 mW                                    |
| PW-14   | 700 mW                                      | 5.6 mW/°C   | 364 mW                                   | 140 mW                                    |

**recommended operating conditions**

|                                       | MIN       | MAX             | UNIT |
|---------------------------------------|-----------|-----------------|------|
| Supply voltage, $V_{DD}$ (see Note 1) | 2.7       | 8               | V    |
| Input voltage range, $V_I$            | $V_{DD-}$ | $V_{DD+} - 1.3$ | V    |
| Common-mode input voltage, $V_{IC}$   | $V_{DD-}$ | $V_{DD+} - 1.3$ | V    |
| Operating free-air temperature, $T_A$ | -40       | 125             | °C   |

NOTE 1: All voltage values, except differential voltages, are with respect to  $V_{DD-}$ .



**TLV225x-EP, TLV225xA-EP**  
**Advanced LinCMOS™ RAIL-TO-RAIL**  
**VERY LOW-POWER OPERATIONAL AMPLIFIERS**

SGLS217B – NOVEMBER 2003 – REVISED JUNE 2006

**TLV2252 electrical characteristics at specified free-air temperature,  $V_{DD} = 3\text{ V}$  (unless otherwise noted)**

| PARAMETER  | TEST CONDITIONS   | $T_A$ †                      | TLV2252    |             |     | TLV2252A  |             |               | UNIT                         |  |
|--|---|------------------------------|------------|-------------|-----|-----------|-------------|---------------|------------------------------|--|
|  |   |                              | MIN        | TYP         | MAX | MIN       | TYP         | MAX           |                              |  |
| $V_{IO}$ Input offset voltage  | $V_{DD\pm} = \pm 1.5\text{ V}$ ,<br>$V_O = 0$ ,<br>$V_{IC} = 0$ ,<br>$R_S = 50\ \Omega$ | 25°C                         | 200        | 1500        |     | 200       | 850         | $\mu\text{V}$ |                              |  |
|  |   | Full range                   |            | 1750        |     | 1000      |             |               |                              |  |
| $\alpha_{VIO}$ Temperature coefficient of input offset voltage               | $V_{DD\pm} = \pm 1.5\text{ V}$ ,<br>$V_O = 0$ ,<br>$V_{IC} = 0$ ,<br>$R_S = 50\ \Omega$ | 25°C to 85°C                 | 0.5        |             |     | 0.5       |             |               | $\mu\text{V}/^\circ\text{C}$ |  |
| Input offset voltage long-term drift (see Note 4)                            | $V_{DD\pm} = \pm 1.5\text{ V}$ ,<br>$V_O = 0$ ,<br>$V_{IC} = 0$ ,<br>$R_S = 50\ \Omega$ | 25°C                         | 0.003      |             |     | 0.003     |             |               | $\mu\text{V}/\text{mo}$      |  |
| $I_{IO}$ Input offset current  | $V_{DD\pm} = \pm 1.5\text{ V}$ ,<br>$V_O = 0$ ,<br>$V_{IC} = 0$ ,<br>$R_S = 50\ \Omega$ | 25°C                         | 0.5        | 60          |     | 0.5       | 60          | $\text{pA}$   |                              |  |
|  |   | 125°C                        |            | 1000        |     | 1000      |             |               |                              |  |
| $I_{IB}$ Input bias current  | $V_{DD\pm} = \pm 1.5\text{ V}$ ,<br>$V_O = 0$ ,<br>$V_{IC} = 0$ ,<br>$R_S = 50\ \Omega$ | 25°C                         | 1          | 60          |     | 1         | 60          | $\text{pA}$   |                              |  |
|  |   | 125°C                        |            | 1000        |     | 1000      |             |               |                              |  |
| $V_{ICR}$ Common-mode input voltage range                                    | $R_S = 50\ \Omega$ ,<br>$ V_{IO}  \leq 5\text{ mV}$                                     | 25°C                         | 0 to 2     | -0.3 to 2.2 |     | 0 to 2    | -0.3 to 2.2 | $\text{V}$    |                              |  |
|  |   | Full range                   | 0 to 1.7   |             |     | 0 to 1.7  |             |               |                              |  |
| $V_{OH}$ High-level output voltage   | $I_{OH} = -20\ \mu\text{A}$   | 25°C                         | 2.98       |             |     | 2.98      |             |               | $\text{V}$                   |  |
|  | $I_{OH} = -75\ \mu\text{A}$   | Full range                   | 2.8        |             |     | 2.8       |             |               |                              |  |
|  | $I_{OH} = -150\ \mu\text{A}$  | 25°C                         | 2.8        |             |     | 2.8       |             |               |                              |  |
| $V_{OL}$ Low-level output voltage  | $V_{IC} = 1.5\text{ V}$ ,<br>$I_{OL} = 50\ \mu\text{A}$                                 | 25°C                         | 10         |             |     | 10        |             |               | $\text{mV}$                  |  |
|  | $V_{IC} = 1.5\text{ V}$ ,<br>$I_{OL} = 500\ \mu\text{A}$                                | Full range                   | 165        |             |     | 165       |             |               |                              |  |
|  | $V_{IC} = 1.5\text{ V}$ ,<br>$I_{OL} = 1\text{ mA}$                                     | 25°C                         | 200        | 300         |     | 200       | 300         |               |                              |  |
|  | Full range  | 300                          |            |             | 300 |           |             |               |                              |  |
| $A_{VD}$ Large-signal differential voltage amplification                     | $V_{IC} = 1.5\text{ V}$ ,<br>$V_O = 1\text{ V to }2\text{ V}$                           | $R_L = 100\text{ k}\Omega$ ‡ | 25°C       | 100         | 250 | 100       | 250         | $\text{V/mV}$ |                              |  |
|  |   | $R_L = 1\text{ M}\Omega$ ‡   | Full range | 10          |     |           | 10          |               |                              |  |
|  |   | 25°C                         | 800        |             |     | 800       |             |               |                              |  |
| $r_{i(d)}$ Differential input resistance                                     |   | 25°C                         | $10^{12}$  |             |     | $10^{12}$ |             |               | $\Omega$                     |  |
| $r_{i(c)}$ Common-mode input resistance                                      |   | 25°C                         | $10^{12}$  |             |     | $10^{12}$ |             |               | $\Omega$                     |  |
| $C_{i(c)}$ Common-mode input capacitance                                     | $f = 10\text{ kHz}$   | 25°C                         | 8          |             |     | 8         |             |               | $\text{pF}$                  |  |
| $z_o$ Closed-loop output impedance   | $f = 25\text{ kHz}$ ,<br>$A_V = 10$   | 25°C                         | 220        |             |     | 220       |             |               | $\Omega$                     |  |
| CMRR Common-mode rejection ratio   | $V_{IC} = 0\text{ to }1.7\text{ V}$ ,<br>$V_O = 1.5\text{ V}$ ,<br>$R_S = 50\ \Omega$   | 25°C                         | 65         | 75          |     | 65        | 77          | $\text{dB}$   |                              |  |
|  |   | Full range                   | 60         |             |     | 60        |             |               |                              |  |
| $k_{SVR}$ Supply-voltage rejection ratio ( $\Delta V_{DD} / \Delta V_{IO}$ ) | $V_{DD} = 2.7\text{ V to }8\text{ V}$ ,<br>$V_{IC} = V_{DD}/2$ ,<br>No load             | 25°C                         | 80         | 95          |     | 80        | 100         | $\text{dB}$   |                              |  |
|  |   | Full range                   | 80         |             |     | 80        |             |               |                              |  |
| $I_{DD}$ Supply current  | $V_O = 1.5\text{ V}$ ,<br>No load   | 25°C                         | 68         | 125         |     | 68        | 125         | $\mu\text{A}$ |                              |  |
|  |   | Full range                   | 150        |             |     | 150       |             |               |                              |  |

† Full range is  $-40^\circ\text{C}$  to  $125^\circ\text{C}$ .

‡ Referenced to 1.5 V

NOTE 4: Typical values are based on the input offset voltage shift observed through 500 hours of operating life test at  $T_A = 150^\circ\text{C}$  extrapolated to  $T_A = 25^\circ\text{C}$  using the Arrhenius equation and assuming an activation energy of 0.96 eV.



**TLV225x-EP, TLV225xA-EP**  
**Advanced LinCMOS™ RAIL-TO-RAIL**  
**VERY LOW-POWER OPERATIONAL AMPLIFIERS**

SGLS217B – NOVEMBER 2003 – REVISED JUNE 2006

**TLV2252 operating characteristics at specified free-air temperature,  $V_{DD} = 3\text{ V}$**

| PARAMETER   | TEST CONDITIONS  | $T_A$ †    | TLV2252 |     |     | TLV2252A |     |     | UNIT                   |
|-------------|--|------------|---------|-----|-----|----------|-----|-----|------------------------|
|             |  |            | MIN     | TYP | MAX | MIN      | TYP | MAX |                        |
| SR          | Slew rate at unity gain<br>$V_O = 0.8\text{ V to }1.4\text{ V}$ , $R_L = 100\text{ k}\Omega$ ‡,<br>$C_L = 100\text{ pF}$ ‡       | 25°C       | 0.07    | 0.1 |     | 0.07     | 0.1 |     | V/ $\mu$ s             |
|             |  | Full range | 0.05    |     |     | 0.05     |     |     |                        |
| $V_n$       | Equivalent input noise voltage<br>$f = 10\text{ Hz}$<br>$f = 1\text{ kHz}$   | 25°C       | 35      |     |     | 35       |     |     | nV/ $\sqrt{\text{Hz}}$ |
|             |  |            | 19      |     |     | 19       |     |     |                        |
| $V_{N(PP)}$ | Peak-to-peak equivalent input noise voltage<br>$f = 0.1\text{ Hz to }1\text{ Hz}$<br>$f = 0.1\text{ Hz to }10\text{ Hz}$         | 25°C       | 0.6     |     |     | 0.6      |     |     | $\mu$ V                |
|             |  |            | 1.1     |     |     | 1.1      |     |     |                        |
| $I_n$       | Equivalent input noise current   | 25°C       | 0.6     |     |     | 0.6      |     |     | fA/ $\sqrt{\text{Hz}}$ |
|             | Gain-bandwidth product<br>$f = 1\text{ kHz}$ , $R_L = 50\text{ k}\Omega$ ‡,<br>$C_L = 100\text{ pF}$ ‡                           | 25°C       | 0.187   |     |     | 0.187    |     |     | MHz                    |
| BOM         | Maximum output-swing bandwidth<br>$V_{O(PP)} = 1\text{ V}$ , $R_L = 50\text{ k}\Omega$ ‡,<br>$A_V = 1$ , $C_L = 100\text{ pF}$ ‡ | 25°C       | 60      |     |     | 60       |     |     | kHz                    |
| $\phi_m$    | Phase margin at unity gain<br>$R_L = 50\text{ k}\Omega$ ‡, $C_L = 100\text{ pF}$ ‡   | 25°C       | 63°     |     |     | 63°      |     |     |                        |
|             | Gain margin<br>$R_L = 50\text{ k}\Omega$ ‡, $C_L = 100\text{ pF}$ ‡  | 25°C       | 15      |     |     | 15       |     |     | dB                     |

† Full range is  $-40^\circ\text{C}$  to  $125^\circ\text{C}$ .

‡ Referenced to 1.5 V

**TLV225x-EP, TLV225xA-EP**  
**Advanced LinCMOS™ RAIL-TO-RAIL**  
**VERY LOW-POWER OPERATIONAL AMPLIFIERS**

SGLS217B – NOVEMBER 2003 – REVISED JUNE 2006

**TLV2252 electrical characteristics at specified free-air temperature,  $V_{DD} = 5\text{ V}$  (unless otherwise noted)**

| PARAMETER  | TEST CONDITIONS  | $T_A$ †                     | TLV2252                       |             |           | TLV2252A    |             |                      | UNIT                         |
|--|--|-----------------------------|-------------------------------|-------------|-----------|-------------|-------------|----------------------|------------------------------|
|  |  |                             | MIN                           | TYP         | MAX       | MIN         | TYP         | MAX                  |                              |
| $V_{IO}$ Input offset voltage  | $V_{DD\pm} = \pm 2.5\text{ V}$ ,<br>$V_O = 0$ ,<br>$V_{IC} = 0$ ,<br>$R_S = 50\ \Omega$    | 25°C                        | 200                           | 1500        |           | 200         | 850         | $\mu\text{V}$        |                              |
|  |  | Full range                  |                               | 1750        |           | 1000        |             |                      |                              |
| $\alpha_{VIO}$ Temperature coefficient of input offset voltage             | $V_{DD\pm} = \pm 2.5\text{ V}$ ,<br>$V_O = 0$ ,<br>$V_{IC} = 0$ ,<br>$R_S = 50\ \Omega$    | 25°C to 85°C                | 0.5                           |             |           | 0.5         |             |                      | $\mu\text{V}/^\circ\text{C}$ |
| Input offset voltage long-term drift (see Note 4)                          | $V_{DD\pm} = \pm 2.5\text{ V}$ ,<br>$V_O = 0$ ,<br>$V_{IC} = 0$ ,<br>$R_S = 50\ \Omega$    | 25°C                        | 0.003                         |             |           | 0.003       |             |                      | $\mu\text{V}/\text{mo}$      |
| $I_{IO}$ Input offset current  | $V_{DD\pm} = \pm 2.5\text{ V}$ ,<br>$V_O = 0$ ,<br>$V_{IC} = 0$ ,<br>$R_S = 50\ \Omega$    | 25°C                        | 0.5                           | 60          |           | 0.5         | 60          | $\text{pA}$          |                              |
|  |  | 125°C                       | 1000                          |             |           | 1000        |             |                      |                              |
| $I_{IB}$ Input bias current  | $V_{DD\pm} = \pm 2.5\text{ V}$ ,<br>$V_O = 0$ ,<br>$V_{IC} = 0$ ,<br>$R_S = 50\ \Omega$    | 25°C                        | 1                             | 60          |           | 1           | 60          | $\text{pA}$          |                              |
|  |  | 125°C                       | 1000                          |             |           | 1000        |             |                      |                              |
| $V_{ICR}$ Common-mode input voltage range                                  | $ V_{IO}  \leq 5\text{ mV}$ ,<br>$R_S = 50\ \Omega$  | 25°C                        | 0 to 4                        | -0.3 to 4.2 |           | 0 to 4      | -0.3 to 4.2 | $\text{V}$           |                              |
|  |  | Full range                  | 0 to 3.5                      |             | 0 to 3.5  |             |             |                      |                              |
| $V_{OH}$ High-level output voltage   | $I_{OH} = -20\ \mu\text{A}$<br>$I_{OH} = -75\ \mu\text{A}$<br>$I_{OH} = -150\ \mu\text{A}$ | 25°C                        | 4.98                          |             | 4.98      |             | $\text{V}$  |                      |                              |
|  |  |                             | 4.9                           | 4.94        | 4.9       | 4.94        |             |                      |                              |
|  |  | Full range                  | 4.8                           |             | 4.8       |             |             |                      |                              |
| $V_{OL}$ Low-level output voltage  | $V_{IC} = 2.5\text{ V}$ ,<br>$I_{OL} = 50\ \mu\text{A}$                                    | 25°C                        | 0.01                          |             | 0.01      |             | $\text{V}$  |                      |                              |
|  |  | Full range                  | 0.09 0.15                     |             | 0.09 0.15 |             |             |                      |                              |
|  | $V_{IC} = 2.5\text{ V}$ ,<br>$I_{OL} = 500\ \mu\text{A}$                                   | 25°C                        | 0.2 0.3                       |             | 0.2 0.3   |             |             |                      |                              |
|  |  | Full range                  | 0.3                           |             | 0.3       |             |             |                      |                              |
| $A_{VD}$ Large-signal differential voltage amplification                   | $V_{IC} = 2.5\text{ V}$ ,<br>$V_O = 1\text{ V to }4\text{ V}$                              | 25°C                        | $R_L = 100\ \text{k}\Omega$ ‡ | 100         | 350       | 100         | 350         | $\text{V}/\text{mV}$ |                              |
|  |  |                             | Full range                    | 10          |           | 10          |             |                      |                              |
|  |  | $R_L = 1\ \text{M}\Omega$ ‡ | 1700                          |             | 1700      |             |             |                      |                              |
| $r_{i(d)}$ Differential input resistance                                   |  | 25°C                        | $10^{12}$                     |             |           | $\Omega$    |             |                      |                              |
| $r_{i(c)}$ Common-mode input resistance                                    |  | 25°C                        | $10^{12}$                     |             |           | $\Omega$    |             |                      |                              |
| $c_{i(c)}$ Common-mode input capacitance                                   | $f = 10\ \text{kHz}$   | 25°C                        | 8                             |             |           | $\text{pF}$ |             |                      |                              |
| $z_o$ Closed-loop output impedance   | $f = 25\ \text{kHz}$ ,<br>$A_V = 10$   | 25°C                        | 200                           |             |           | $\Omega$    |             |                      |                              |
| CMRR Common-mode rejection ratio   | $V_{IC} = 0\text{ to }2.7\text{ V}$ ,<br>$V_O = 2.5\text{ V}$ ,<br>$R_S = 50\ \Omega$      | 25°C                        | 70                            | 83          |           | 70          | 83          | $\text{dB}$          |                              |
|  |  | Full range                  | 70                            |             |           | 70          |             |                      |                              |
| $k_{SVR}$ Supply-voltage rejection ratio ( $\Delta V_{DD}/\Delta V_{IO}$ ) | $V_{DD} = 4.4\text{ V to }8\text{ V}$ ,<br>$V_{IC} = V_{DD}/2$ ,<br>No load                | 25°C                        | 80                            | 95          |           | 80          | 95          | $\text{dB}$          |                              |
|  |  | Full range                  | 80                            |             |           | 80          |             |                      |                              |

† Full range is  $-40^\circ\text{C}$  to  $125^\circ\text{C}$ .

‡ Referenced to 2.5 V

NOTE 4: Typical values are based on the input offset voltage shift observed through 500 hours of operating life test at  $T_A = 150^\circ\text{C}$  extrapolated to  $T_A = 25^\circ\text{C}$  using the Arrhenius equation and assuming an activation energy of 0.96 eV.



**TLV225x-EP, TLV225xA-EP**  
**Advanced LinCMOS™ RAIL-TO-RAIL**  
**VERY LOW-POWER OPERATIONAL AMPLIFIERS**

SGLS217B – NOVEMBER 2003 – REVISED JUNE 2006

**TLV2252 electrical characteristics at specified free-air temperature,  $V_{DD} = 5\text{ V}$  (unless otherwise noted) (continued)**

| PARAMETER               | TEST CONDITIONS                | $T_A$ †    | TLV2252 |     |     | TLV2252A |     |               | UNIT |
|-------------------------|--------------------------------|------------|---------|-----|-----|----------|-----|---------------|------|
|                         |                                |            | MIN     | TYP | MAX | MIN      | TYP | MAX           |      |
| $I_{DD}$ Supply current | $V_O = 2.5\text{ V}$ , No load | 25°C       | 70      | 125 |     | 70       | 125 | $\mu\text{A}$ |      |
|                         |                                | Full range |         | 150 |     |          | 150 |               |      |

† Full range is  $-40^\circ\text{C}$  to  $125^\circ\text{C}$  for Q level part.

**TLV2252 operating characteristics at specified free-air temperature,  $V_{DD} = 5\text{ V}$**

| PARAMETER   | TEST CONDITIONS   | $T_A$ †    | TLV2252 |            |     | TLV2252A |      |                              | UNIT |
|---|---|------------|---------|------------|-----|----------|------|------------------------------|------|
|   |   |            | MIN     | TYP        | MAX | MIN      | TYP  | MAX                          |      |
| SR Slew rate at unity gain                              | $V_O = 1.25\text{ V}$ to $2.75\text{ V}$ ,<br>$R_L = 100\text{ k}\Omega$ ‡, $C_L = 100\text{ pF}$ ‡ | 25°C       | 0.07    | 0.12       |     | 0.07     | 0.12 | $\text{V}/\mu\text{s}$       |      |
|   |   | Full range | 0.05    |            |     | 0.05     |      |                              |      |
| $V_n$ Equivalent input noise voltage                    | $f = 10\text{ Hz}$  | 25°C       |         | 36         |     |          | 36   | $\text{nV}/\sqrt{\text{Hz}}$ |      |
|   | $f = 1\text{ kHz}$  | 25°C       |         | 19         |     |          | 19   |                              |      |
| $V_{N(PP)}$ Peak-to-peak equivalent input noise voltage | $f = 0.1\text{ Hz}$ to $1\text{ Hz}$  | 25°C       |         | 0.7        |     |          | 0.7  | $\mu\text{V}$                |      |
|   | $f = 0.1\text{ Hz}$ to $10\text{ Hz}$   | 25°C       |         | 1.1        |     |          | 1.1  |                              |      |
| $I_n$ Equivalent input noise current                    |   | 25°C       |         | 0.6        |     |          | 0.6  | $\text{fA}/\sqrt{\text{Hz}}$ |      |
| THD+N Total harmonic distortion plus noise              | $V_O = 0.5\text{ V}$ to $2.5\text{ V}$ ,<br>$f = 20\text{ kHz}$ ,<br>$R_L = 50\text{ k}\Omega$ ‡    | 25°C       |         | $A_V = 1$  |     | 0.2%     |      | 0.2%                         |      |
|   |   |            |         | $A_V = 10$ |     | 1%       |      | 1%                           |      |
| Gain-bandwidth product                                  | $f = 50\text{ kHz}$ ,<br>$C_L = 100\text{ pF}$ ‡  | 25°C       |         |            |     | 0.2      |      | 0.2                          | MHz  |
| BOM Maximum output-swing bandwidth                      | $V_{O(PP)} = 2\text{ V}$ ,<br>$R_L = 50\text{ k}\Omega$ ‡   | 25°C       |         |            |     | 30       |      | 30                           | kHz  |
| $\phi_m$ Phase margin at unity gain                     | $R_L = 50\text{ k}\Omega$ ‡, $C_L = 100\text{ pF}$ ‡  | 25°C       |         |            |     | 63°      |      | 63°                          |      |
| Gain margin   | $R_L = 50\text{ k}\Omega$ ‡, $C_L = 100\text{ pF}$ ‡  | 25°C       |         |            |     | 15       |      | 15                           | dB   |

† Full range is  $-40^\circ\text{C}$  to  $125^\circ\text{C}$ .

‡ Referenced to  $2.5\text{ V}$





**TLV225x-EP, TLV225xA-EP**  
**Advanced LinCMOS™ RAIL-TO-RAIL**  
**VERY LOW-POWER OPERATIONAL AMPLIFIERS**

SGLS217B – NOVEMBER 2003 – REVISED JUNE 2006

**TLV2254 electrical characteristics at specified free-air temperature,  $V_{DD} = 3\text{ V}$  (unless otherwise noted)**

| PARAMETER  | TEST CONDITIONS  | $T_A$ †                       | TLV2254    |             |      | TLV2254A  |             |               | UNIT                         |
|--|--|-------------------------------|------------|-------------|------|-----------|-------------|---------------|------------------------------|
|  |  |                               | MIN        | TYP         | MAX  | MIN       | TYP         | MAX           |                              |
| $V_{IO}$ Input offset voltage  | $V_{DD} \pm \pm 1.5\text{ V}$ ,<br>$V_O = 0$ ,<br>$V_{IC} = 0$ ,<br>$R_S = 50\ \Omega$ | 25°C                          | 200        | 1500        |      | 200       | 850         | $\mu\text{V}$ |                              |
|  |  | Full range                    |            |             | 1750 |           | 1000        |               |                              |
| $\alpha_{VIO}$ Temperature coefficient of input offset voltage             | $V_{DD} \pm \pm 1.5\text{ V}$ ,<br>$V_O = 0$ ,<br>$V_{IC} = 0$ ,<br>$R_S = 50\ \Omega$ | 25°C to 125°C                 | 0.5        |             |      | 0.5       |             |               | $\mu\text{V}/^\circ\text{C}$ |
| Input offset voltage long-term drift (see Note 4)                          | $V_{DD} \pm \pm 1.5\text{ V}$ ,<br>$V_O = 0$ ,<br>$V_{IC} = 0$ ,<br>$R_S = 50\ \Omega$ | 25°C                          | 0.003      |             |      | 0.003     |             |               | $\mu\text{V}/\text{mo}$      |
| $I_{IO}$ Input offset current  | $V_{DD} \pm \pm 1.5\text{ V}$ ,<br>$V_O = 0$ ,<br>$V_{IC} = 0$ ,<br>$R_S = 50\ \Omega$ | 25°C                          | 0.5        | 60          |      | 0.5       | 60          | $\text{pA}$   |                              |
|  |  | 125°C                         |            |             | 1000 |           | 1000        |               |                              |
| $I_{IB}$ Input bias current  | $V_{DD} \pm \pm 1.5\text{ V}$ ,<br>$V_O = 0$ ,<br>$V_{IC} = 0$ ,<br>$R_S = 50\ \Omega$ | 25°C                          | 1          | 60          |      | 1         | 60          | $\text{pA}$   |                              |
|  |  | 125°C                         |            |             | 1000 |           | 1000        |               |                              |
| $V_{ICR}$ Common-mode input voltage range                                  | $R_S = 50\ \Omega$ ,<br>$ V_{IO}  \leq 5\text{ mV}$                                    | 25°C                          | 0 to 2     | -0.3 to 2.2 |      | 0 to 2    | -0.3 to 2.2 | $\text{V}$    |                              |
|  |  | Full range                    | 0 to 1.7   |             |      | 0 to 1.7  |             |               |                              |
| $V_{OH}$ High-level output voltage   | $I_{OH} = -20\ \mu\text{A}$  | 25°C                          | 2.98       |             |      | 2.98      |             |               | $\text{V}$                   |
|  |  |                               | 2.9        |             |      | 2.9       |             |               |                              |
|  |  | Full range                    | 2.8        |             |      | 2.8       |             |               |                              |
|  | $I_{OH} = -150\ \mu\text{A}$   | 25°C                          | 2.8        |             |      | 2.8       |             |               |                              |
| $V_{OL}$ Low-level output voltage  | $V_{IC} = 1.5\text{ V}$ ,<br>$I_{OL} = 50\ \mu\text{A}$                                | 25°C                          | 10         |             |      | 10        |             |               | $\text{mV}$                  |
|  |  | Full range                    | 100        | 150         |      | 100       | 150         |               |                              |
|  | $V_{IC} = 1.5\text{ V}$ ,<br>$I_{OL} = 500\ \mu\text{A}$                               | 25°C                          | 165        |             |      | 165       |             |               |                              |
|  |  | Full range                    | 200        | 300         |      | 200       | 300         |               |                              |
| $A_{VD}$ Large-signal differential voltage amplification                   | $V_{IC} = 1.5\text{ V}$ ,<br>$V_O = 1\text{ V to }2\text{ V}$                          | $R_L = 100\ \text{k}\Omega$ ‡ | 25°C       | 100         | 225  |           | 100         | 225           | $\text{V/mV}$                |
|  |  |                               | Full range | 10          |      |           | 10          |               |                              |
|  |  | $R_L = 1\ \text{M}\Omega$ ‡   | 25°C       | 800         |      |           | 800         |               |                              |
| $r_{i(d)}$ Differential input resistance                                   |  | 25°C                          | $10^{12}$  |             |      | $10^{12}$ |             |               | $\Omega$                     |
| $r_{i(c)}$ Common-mode input resistance                                    |  | 25°C                          | $10^{12}$  |             |      | $10^{12}$ |             |               | $\Omega$                     |
| $c_{i(c)}$ Common-mode input capacitance                                   | $f = 10\ \text{kHz}$   | 25°C                          | 8          |             |      | 8         |             |               | $\text{pF}$                  |
| $z_o$ Closed-loop output impedance   | $f = 25\ \text{kHz}$ ,<br>$A_V = 10$   | 25°C                          | 220        |             |      | 220       |             |               | $\Omega$                     |
| CMRR Common-mode rejection ratio   | $V_{IC} = 0\text{ to }1.7\text{ V}$ ,<br>$V_O = 1.5\text{ V}$ ,<br>$R_S = 50\ \Omega$  | 25°C                          | 65         | 75          |      | 65        | 77          | $\text{dB}$   |                              |
|  |  | Full range                    | 60         |             |      | 60        |             |               |                              |
| $k_{SVR}$ Supply-voltage rejection ratio ( $\Delta V_{DD}/\Delta V_{IO}$ ) | $V_{DD} = 2.7\text{ V to }8\text{ V}$ ,<br>$V_{IC} = V_{DD}/2$ ,<br>No load            | 25°C                          | 80         | 95          |      | 80        | 100         | $\text{dB}$   |                              |
|  |  | Full range                    | 80         |             |      | 80        |             |               |                              |

† Full range is  $-40^\circ\text{C}$  to  $125^\circ\text{C}$ .

‡ Referenced to 1.5 V

NOTE 4: Typical values are based on the input offset voltage shift observed through 500 hours of operating life test at  $T_A = 150^\circ\text{C}$  extrapolated to  $T_A = 25^\circ\text{C}$  using the Arrhenius equation and assuming an activation energy of 0.96 eV.



**TLV225x-EP, TLV225xA-EP**  
**Advanced LinCMOS™ RAIL-TO-RAIL**  
**VERY LOW-POWER OPERATIONAL AMPLIFIERS**

SGLS217B – NOVEMBER 2003 – REVISED JUNE 2006

**TLV2254 electrical characteristics at specified free-air temperature,  $V_{DD} = 3\text{ V}$  (unless otherwise noted) (continued)**

| PARAMETER | TEST CONDITIONS                     | $T_A$ †                           | TLV2254    |     |     | TLV2254A |     |               | UNIT |
|-----------|-------------------------------------|-----------------------------------|------------|-----|-----|----------|-----|---------------|------|
|           |                                     |                                   | MIN        | TYP | MAX | MIN      | TYP | MAX           |      |
| $I_{DD}$  | Supply current<br>(four amplifiers) | $V_O = 1.5\text{ V}$ ,<br>No load | 25°C       | 135 | 250 | 135      | 250 | $\mu\text{A}$ |      |
|           |                                     |                                   | Full range | 300 |     |          | 300 |               |      |

† Full range is  $-40^\circ\text{C}$  to  $125^\circ\text{C}$  for Q level part.

**TLV2254 operating characteristics at specified free-air temperature,  $V_{DD} = 3\text{ V}$**

| PARAMETER   | TEST CONDITIONS                             | $T_A$ †  | TLV2254    |       |     | TLV2254A |       |                        | UNIT |                              |
|-------------|---|--|------------|-------|-----|----------|-------|------------------------|------|------------------------------|
|             |   |  | MIN        | TYP   | MAX | MIN      | TYP   | MAX                    |      |                              |
| SR          | Slew rate at unity gain                     | $V_O = 0.5\text{ V}$ to $1.7\text{ V}$ ,<br>$R_L = 100\text{ k}\Omega$ ‡,<br>$C_L = 100\text{ pF}$ ‡ | 25°C       | 0.07  | 0.1 | 0.07     | 0.1   | $\text{V}/\mu\text{s}$ |      |                              |
|             |   |  | Full range | 0.05  |     |          | 0.05  |                        |      |                              |
| $V_n$       | Equivalent input noise voltage              | $f = 10\text{ Hz}$<br>$f = 1\text{ kHz}$   | 25°C       | 35    |     |          | 35    |                        |      | $\text{nV}/\sqrt{\text{Hz}}$ |
|             |   |  |            | 19    |     |          | 19    |                        |      |                              |
| $V_{N(PP)}$ | Peak-to-peak equivalent input noise voltage | $f = 0.1\text{ Hz}$ to $1\text{ Hz}$<br>$f = 0.1\text{ Hz}$ to $10\text{ Hz}$                        | 25°C       | 0.6   |     |          | 0.6   |                        |      | $\mu\text{V}$                |
|             |   |  |            | 1.1   |     |          | 1.1   |                        |      |                              |
| $I_n$       | Equivalent input noise current              |  | 25°C       | 0.6   |     |          | 0.6   |                        |      | $\text{fA}/\sqrt{\text{Hz}}$ |
|             | Gain-bandwidth product                      | $f = 1\text{ kHz}$ ,<br>$R_L = 50\text{ k}\Omega$ ‡,<br>$C_L = 100\text{ pF}$ ‡                      | 25°C       | 0.187 |     |          | 0.187 |                        |      | MHz                          |
| BOM         | Maximum output-swing bandwidth              | $V_{O(PP)} = 1\text{ V}$ ,<br>$A_V = 1$ ,<br>$R_L = 50\text{ k}\Omega$ ‡,<br>$C_L = 100\text{ pF}$ ‡ | 25°C       | 60    |     |          | 60    |                        |      | kHz                          |
| $\phi_m$    | Phase margin at unity gain                  | $R_L = 50\text{ k}\Omega$ ‡,<br>$C_L = 100\text{ pF}$ ‡  | 25°C       | 63°   |     |          | 63°   |                        |      |                              |
|             | Gain margin                                 | $R_L = 50\text{ k}\Omega$ ‡,<br>$C_L = 100\text{ pF}$ ‡  | 25°C       | 15    |     |          | 15    |                        |      | dB                           |

† Full range is  $-40^\circ\text{C}$  to  $125^\circ\text{C}$  for Q level part.

‡ Referenced to 1.5 V



**TLV225x-EP, TLV225xA-EP**  
**Advanced LinCMOS™ RAIL-TO-RAIL**  
**VERY LOW-POWER OPERATIONAL AMPLIFIERS**

SGLS217B – NOVEMBER 2003 – REVISED JUNE 2006

**TLV2254 electrical characteristics at specified free-air temperature,  $V_{DD} = 5\text{ V}$  (unless otherwise noted)**

| PARAMETER  | TEST CONDITIONS   | $T_A$ †                       | TLV2254          |             |      | TLV2254A         |             |      | UNIT                         |      |
|--|---|-------------------------------|------------------|-------------|------|------------------|-------------|------|------------------------------|------|
|  |   |                               | MIN              | TYP         | MAX  | MIN              | TYP         | MAX  |                              |      |
| $V_{IO}$ Input offset voltage  | $V_{DD\pm} = \pm 2.5\text{ V}$ ,<br>$V_O = 0$ ,<br>$V_{IC} = 0$ ,<br>$R_S = 50\ \Omega$ | 25°C                          | 200              |             | 1500 | 200              |             | 850  | $\mu\text{V}$                |      |
|  |   | Full range                    |                  |             |      | 1750             |             |      |                              | 1000 |
| $\alpha_{VIO}$ Temperature coefficient of input offset voltage             | $V_{DD\pm} = \pm 2.5\text{ V}$ ,<br>$V_O = 0$ ,<br>$V_{IC} = 0$ ,<br>$R_S = 50\ \Omega$ | 25°C to 125°C                 | 0.5              |             |      | 0.5              |             |      | $\mu\text{V}/^\circ\text{C}$ |      |
| Input offset voltage long-term drift (see Note 4)                          | $V_{DD\pm} = \pm 2.5\text{ V}$ ,<br>$V_O = 0$ ,<br>$V_{IC} = 0$ ,<br>$R_S = 50\ \Omega$ | 25°C                          | 0.003            |             |      | 0.003            |             |      | $\mu\text{V}/\text{mo}$      |      |
| $I_{IO}$ Input offset current  | $V_{DD\pm} = \pm 2.5\text{ V}$ ,<br>$V_O = 0$ ,<br>$V_{IC} = 0$ ,<br>$R_S = 50\ \Omega$ | 25°C                          | 0.5              |             | 60   | 0.5              |             | 60   | $\text{pA}$                  |      |
|  |   | 125°C                         |                  |             |      | 1000             |             |      |                              |      |
| $I_{IB}$ Input bias current  | $V_{DD\pm} = \pm 2.5\text{ V}$ ,<br>$V_O = 0$ ,<br>$V_{IC} = 0$ ,<br>$R_S = 50\ \Omega$ | 25°C                          | 1                |             | 60   | 1                |             | 60   | $\text{pA}$                  |      |
|  |   | 125°C                         |                  |             |      | 1000             |             |      |                              |      |
| $V_{ICR}$ Common-mode input voltage range                                  | $ V_{IO}  \leq 5\text{ mV}$ ,<br>$R_S = 50\ \Omega$                                     | 25°C                          | 0 to 4           | -0.3 to 4.2 |      | 0 to 4           | -0.3 to 4.2 |      | V                            |      |
|  |   | Full range                    | 0 to 3.5         |             |      | 0 to 3.5         |             |      |                              |      |
| $V_{OH}$ High-level output voltage   | $I_{OH} = -20\ \mu\text{A}$   | 25°C                          | 4.98             |             |      | 4.98             |             |      | V                            |      |
|  | $I_{OH} = -75\ \mu\text{A}$   | 25°C                          | 4.9              | 4.94        |      | 4.9              | 4.94        |      |                              |      |
|  | $I_{OH} = -150\ \mu\text{A}$  | 25°C                          | 4.8              |             | 4.88 | 4.8              |             | 4.88 |                              |      |
| $V_{OL}$ Low-level output voltage  | $V_{IC} = 2.5\text{ V}$ ,<br>$I_{OL} = 50\ \mu\text{A}$                                 | 25°C                          | 0.01             |             |      | 0.01             |             |      | V                            |      |
|  |   | Full range                    | 0.09             |             | 0.15 | 0.09             |             | 0.15 |                              |      |
|  | $V_{IC} = 2.5\text{ V}$ ,<br>$I_{OL} = 500\ \mu\text{A}$                                | 25°C                          | 0.2              |             | 0.3  | 0.2              |             | 0.3  |                              |      |
|  |   | Full range                    |                  |             |      | 0.3              |             |      |                              |      |
| $A_{VD}$ Large-signal differential voltage amplification                   | $V_{IC} = 2.5\text{ V}$ ,<br>$V_O = 1\text{ V to }4\text{ V}$                           | $R_L = 100\ \text{k}\Omega$ ‡ | 25°C             | 100         | 350  | 100              | 350         |      | V/mV                         |      |
|  |   | $R_L = 1\ \text{M}\Omega$ ‡   | 25°C             | 10          |      |                  | 10          |      |                              |      |
|  |   |                               | Full range       |             |      |                  | 1700        |      |                              |      |
| $r_{i(d)}$ Differential input resistance                                   |   | 25°C                          | 10 <sup>12</sup> |             |      | 10 <sup>12</sup> |             |      | $\Omega$                     |      |
| $r_{i(c)}$ Common-mode input resistance                                    |   | 25°C                          | 10 <sup>12</sup> |             |      | 10 <sup>12</sup> |             |      | $\Omega$                     |      |
| $c_{i(c)}$ Common-mode input capacitance                                   | $f = 10\text{ kHz}$   | 25°C                          | 8                |             |      | 8                |             |      | pF                           |      |
| $z_o$ Closed-loop output impedance   | $f = 25\text{ kHz}$ ,<br>$A_V = 10$   | 25°C                          | 200              |             |      | 200              |             |      | $\Omega$                     |      |
| CMRR Common-mode rejection ratio   | $V_{IC} = 0\text{ to }2.7\text{ V}$ ,<br>$V_O = 2.5\text{ V}$ ,<br>$R_S = 50\ \Omega$   | 25°C                          | 70               | 83          |      | 70               | 83          |      | dB                           |      |
|  |   | Full range                    | 70               |             |      | 70               |             |      |                              |      |
| $k_{SVR}$ Supply-voltage rejection ratio ( $\Delta V_{DD}/\Delta V_{IO}$ ) | $V_{DD} = 4.4\text{ V to }8\text{ V}$ ,<br>$V_{IC} = V_{DD}/2$ ,<br>No load             | 25°C                          | 80               | 95          |      | 80               | 95          |      | dB                           |      |
|  |   | Full range                    | 80               |             |      | 80               |             |      |                              |      |

† Full range is -40°C to 125°C.

‡ Referenced to 2.5 V

NOTE 4: Typical values are based on the input offset voltage shift observed through 500 hours of operating life test at  $T_A = 150^\circ\text{C}$  extrapolated to  $T_A = 25^\circ\text{C}$  using the Arrhenius equation and assuming an activation energy of 0.96 eV.



**TLV225x-EP, TLV225xA-EP**  
**Advanced LinCMOS™ RAIL-TO-RAIL**  
**VERY LOW-POWER OPERATIONAL AMPLIFIERS**

SGLS217B – NOVEMBER 2003 – REVISED JUNE 2006

**TLV2254 electrical characteristics at specified free-air temperature,  $V_{DD} = 5\text{ V}$  (unless otherwise noted) (continued)**

| PARAMETER | TEST CONDITIONS                     | $T_A$ †                           | TLV2254    |     |     | TLV2254A |     |               | UNIT |
|-----------|-------------------------------------|-----------------------------------|------------|-----|-----|----------|-----|---------------|------|
|           |                                     |                                   | MIN        | TYP | MAX | MIN      | TYP | MAX           |      |
| $I_{DD}$  | Supply current<br>(four amplifiers) | $V_O = 2.5\text{ V}$ ,<br>No load | 25°C       | 140 | 250 | 140      | 250 | $\mu\text{A}$ |      |
|           |                                     |                                   | Full range | 300 |     |          | 300 |               |      |

† Full range is  $-40^\circ\text{C}$  to  $125^\circ\text{C}$ .

**TLV2254 operating characteristics at specified free-air temperature,  $V_{DD} = 5\text{ V}$**

| PARAMETER   | TEST CONDITIONS                                   | $T_A$ †  | TLV2254    |  |      | TLV2254A |      |                              | UNIT |
|-------------|---|--|------------|--|------|----------|------|------------------------------|------|
|             |   |  | MIN        | TYP                                    | MAX  | MIN      | TYP  | MAX                          |      |
| SR          | Slew rate<br>at unity gain                        | $V_O = 0.5\text{ V}$ to $3.5\text{ V}$ ,<br>$R_L = 100\text{ k}\Omega$ ‡,<br>$C_L = 100\text{ pF}$ ‡ | 25°C       | 0.07                                   | 0.12 | 0.07     | 0.12 | $\text{V}/\mu\text{s}$       |      |
|             |   |  | Full range | 0.05                                   |      |          | 0.05 |                              |      |
| $V_n$       | Equivalent input<br>noise voltage                 | $f = 10\text{ Hz}$<br>$f = 1\text{ kHz}$   | 25°C       | 36                                     |      | 36       |      | $\text{nV}/\sqrt{\text{Hz}}$ |      |
|             |   |  |            | 19                                     |      | 19       |      |                              |      |
| $V_{N(PP)}$ | Peak-to-peak<br>equivalent input<br>noise voltage | $f = 0.1\text{ Hz}$ to $1\text{ Hz}$<br>$f = 0.1\text{ Hz}$ to $10\text{ Hz}$                        | 25°C       | 0.7                                    |      | 0.7      |      | $\mu\text{V}$                |      |
|             |   |  |            | 1.1                                    |      | 1.1      |      |                              |      |
| $I_n$       | Equivalent input<br>noise current                 |  | 25°C       | 0.6                                    |      | 0.6      |      | $\text{fA}/\sqrt{\text{Hz}}$ |      |
| THD+N       | Total harmonic<br>distortion plus<br>noise        | $V_O = 0.5\text{ V}$ to $2.5\text{ V}$ ,<br>$f = 20\text{ kHz}$ ,<br>$R_L = 50\text{ k}\Omega$ ‡     | 25°C       | $A_V = 1$                              |      | 0.2%     |      |                              |      |
|             |   |  |            | $A_V = 10$                             |      | 1%       |      |                              |      |
|             | Gain-bandwidth<br>product                         | $f = 50\text{ kHz}$ ,<br>$C_L = 100\text{ pF}$ ‡   | 25°C       | $R_L = 50\text{ k}\Omega$ ‡            |      | 0.2      |      | MHz                          |      |
| BOM         | Maximum output-<br>swing bandwidth                | $V_{O(PP)} = 2\text{ V}$ ,<br>$R_L = 50\text{ k}\Omega$ ‡  | 25°C       | $A_V = 1$ ,<br>$C_L = 100\text{ pF}$ ‡ |      | 30       |      | kHz                          |      |
| $\phi_m$    | Phase margin<br>at unity gain                     | $R_L = 50\text{ k}\Omega$ ‡,<br>$C_L = 100\text{ pF}$ ‡  | 25°C       |  |      | 63°      |      |                              |      |
|             | Gain margin                                       | $R_L = 50\text{ k}\Omega$ ‡,<br>$C_L = 100\text{ pF}$ ‡  | 25°C       |  |      | 15       |      | dB                           |      |

† Full range is  $-40^\circ\text{C}$  to  $125^\circ\text{C}$  for Q level part.

‡ Referenced to 2.5 V



## TYPICAL CHARACTERISTICS

**Table of Graphs**

|                 |   | FIGURE  |
|-----------------|---|---|
| $V_{IO}$        | Input offset voltage                            | Distribution vs Common-mode voltage<br>2–5<br>6, 7          |
| $\alpha_{VIO}$  | Input offset voltage temperature coefficient    | Distribution<br>8–11  |
| $I_{IB}/I_{IO}$ | Input bias and input offset currents            | vs Free-air temperature<br>12                               |
| $V_I$           | Input voltage                                   | vs Supply voltage<br>vs Free-air temperature<br>13<br>14    |
| $V_{OH}$        | High-level output voltage                       | vs High-level output current<br>15, 18                      |
| $V_{OL}$        | Low-level output voltage                        | vs Low-level output current<br>16, 17, 19                   |
| $V_{O(PP)}$     | Maximum peak-to-peak output voltage             | vs Frequency<br>20  |
| $I_{OS}$        | Short-circuit output current                    | vs Supply voltage<br>vs Free-air temperature<br>21<br>22    |
| $V_{ID}$        | Differential input voltage                      | vs Output voltage<br>23, 24                                 |
| $A_{VD}$        | Differential voltage amplification              | vs Load resistance<br>25                                    |
| $A_{VD}$        | Large-signal differential voltage amplification | vs Frequency<br>vs Free-air temperature<br>26, 27<br>28, 29 |
| $z_o$           | Output impedance                                | vs Frequency<br>30, 31                                      |
| CMRR            | Common-mode rejection ratio                     | vs Frequency<br>vs Free-air temperature<br>32<br>33         |
| $k_{SVR}$       | Supply-voltage rejection ratio                  | vs Frequency<br>vs Free-air temperature<br>34, 35<br>36     |
| $I_{DD}$        | Supply current                                  | vs Supply voltage<br>37, 38                                 |
| SR              | Slew rate                                       | vs Load capacitance<br>vs Free-air temperature<br>39<br>40  |
| $V_O$           | Inverting large-signal pulse response           | 41, 42  |
| $V_O$           | Voltage-follower large-signal pulse response    | 43, 44  |
| $V_O$           | Inverting small-signal pulse response           | 45, 46  |
| $V_O$           | Voltage-follower small-signal pulse response    | 47, 48  |
| $V_n$           | Equivalent input noise voltage                  | vs Frequency<br>49, 50                                      |
|                 | Input noise voltage                             | Over a 10-s period<br>51                                    |
|                 | Integrated noise voltage                        | vs Frequency<br>52  |
| THD+N           | Total harmonic distortion plus noise            | vs Frequency<br>53  |
|                 | Gain-bandwidth product                          | vs Supply voltage<br>vs Free-air temperature<br>54<br>55    |
| $\phi_m$        | Phase margin                                    | vs Frequency<br>vs Load capacitance<br>26, 27<br>56         |
|                 | Gain margin                                     | vs Load capacitance<br>57                                   |
| $B_1$           | Unity-gain bandwidth                            | vs Load capacitance<br>58                                   |
|                 | Overestimation of phase margin                  | vs Load capacitance<br>59                                   |

**TLV225x-EP, TLV225xA-EP**  
**Advanced LinCMOS™ RAIL-TO-RAIL**  
**VERY LOW-POWER OPERATIONAL AMPLIFIERS**

SGLS217B – NOVEMBER 2003 – REVISED JUNE 2006

**TYPICAL CHARACTERISTICS**

**DISTRIBUTION OF TLV2252  
INPUT OFFSET VOLTAGE**

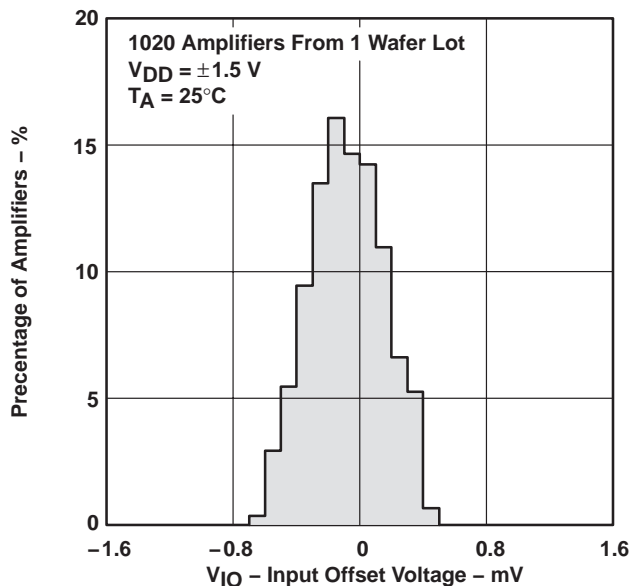

**Figure 2**

**DISTRIBUTION OF TLV2252  
INPUT OFFSET VOLTAGE**

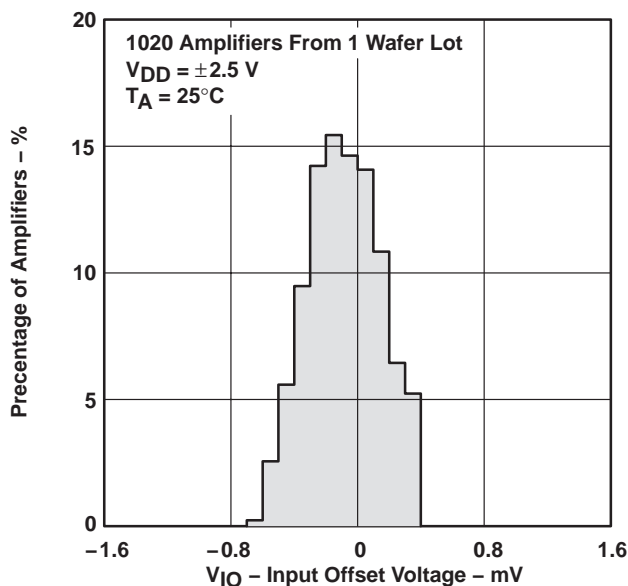

**Figure 3**

**DISTRIBUTION OF TLV2254  
INPUT OFFSET VOLTAGE**

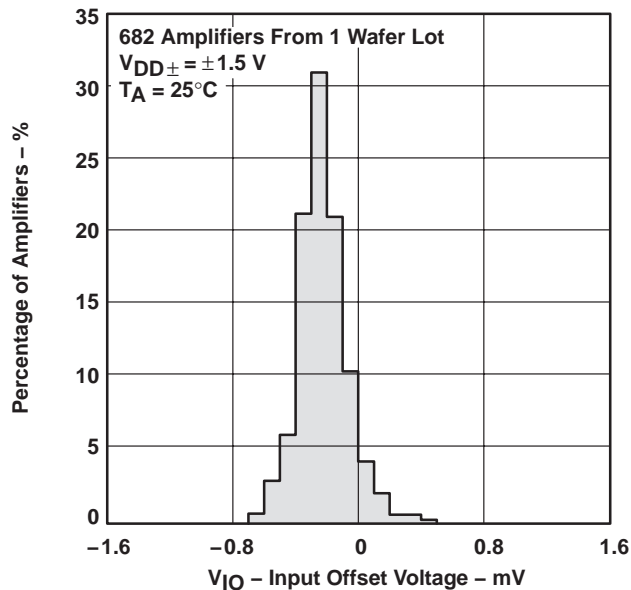

**Figure 4**

**DISTRIBUTION OF TLV2254  
INPUT OFFSET VOLTAGE**

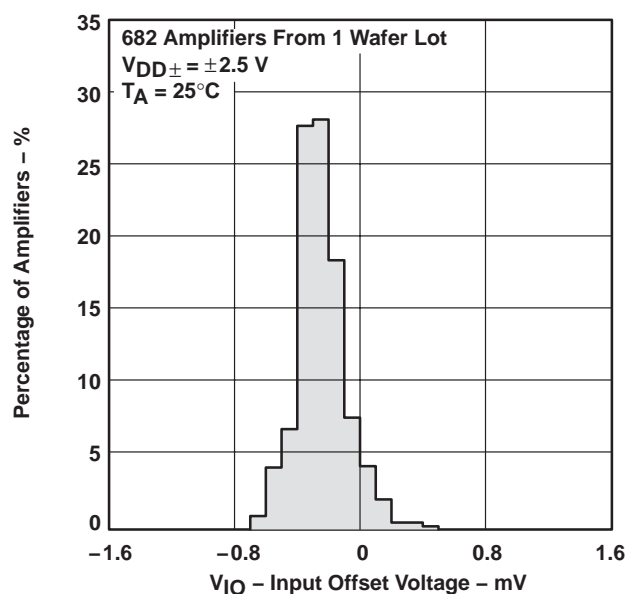

**Figure 5**



TYPICAL CHARACTERISTICS

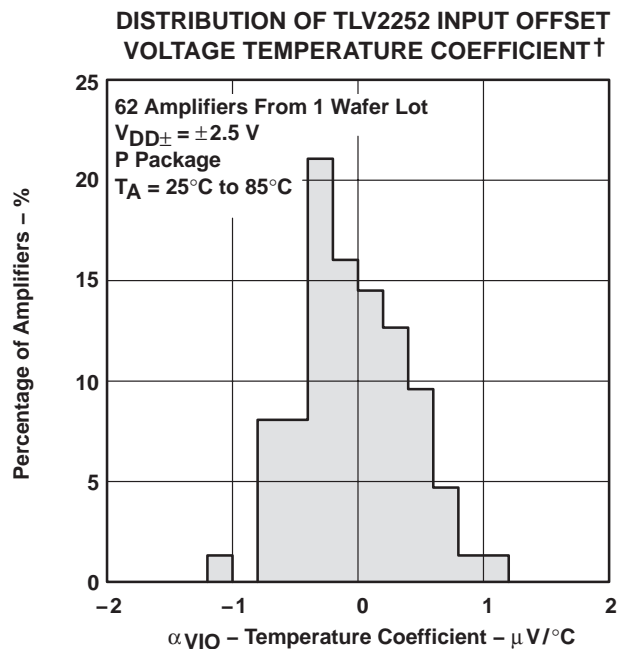
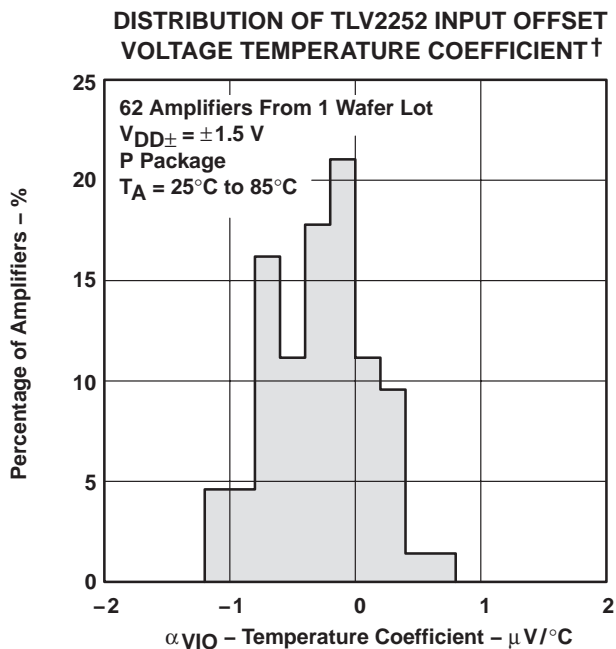
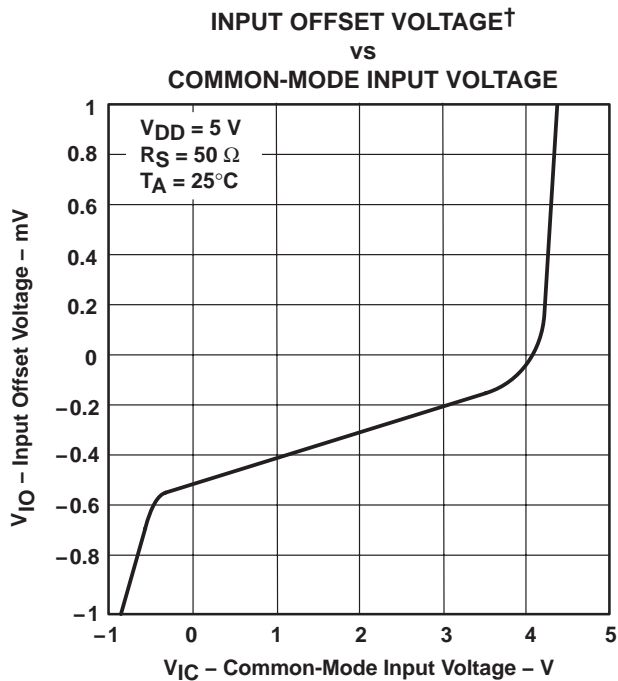
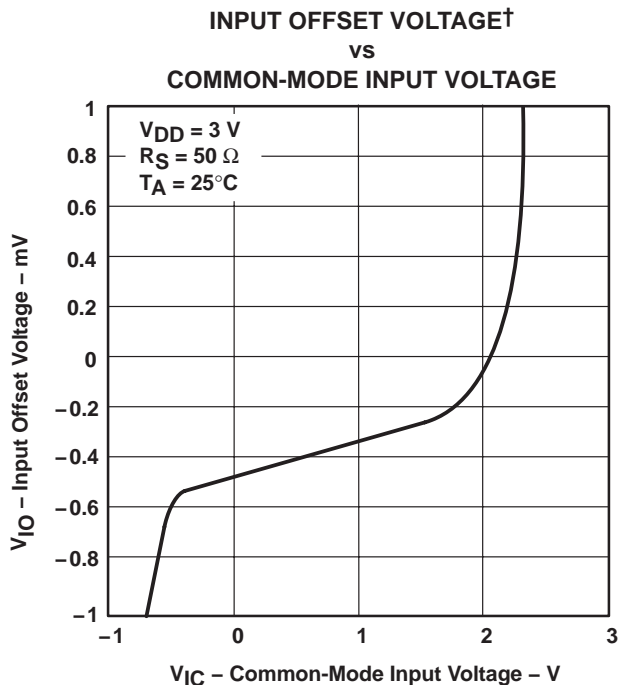

† For all curves where  $V_{DD} = 5\text{ V}$ , all loads are referenced to 2.5 V. For all curves where  $V_{DD} = 3\text{ V}$ , all loads are referenced to 1.5 V.

**TYPICAL CHARACTERISTICS**

**DISTRIBUTION OF TLV2254 INPUT OFFSET VOLTAGE TEMPERATURE COEFFICIENT**

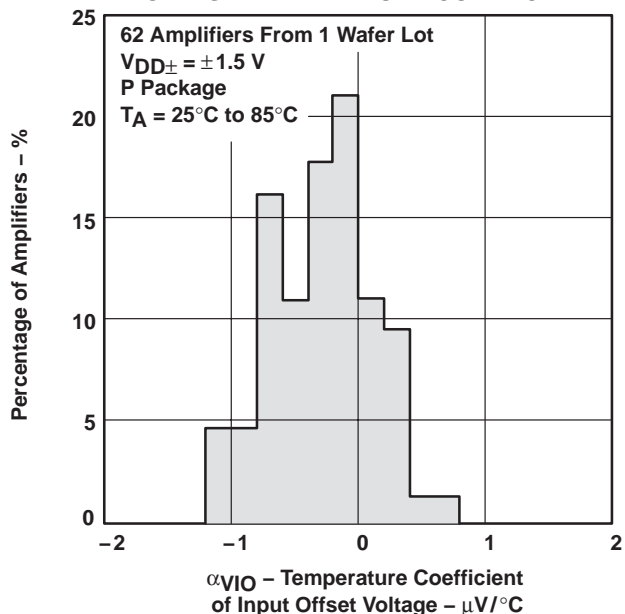

**Figure 10**

**DISTRIBUTION OF TLV2254 INPUT OFFSET VOLTAGE TEMPERATURE COEFFICIENT**

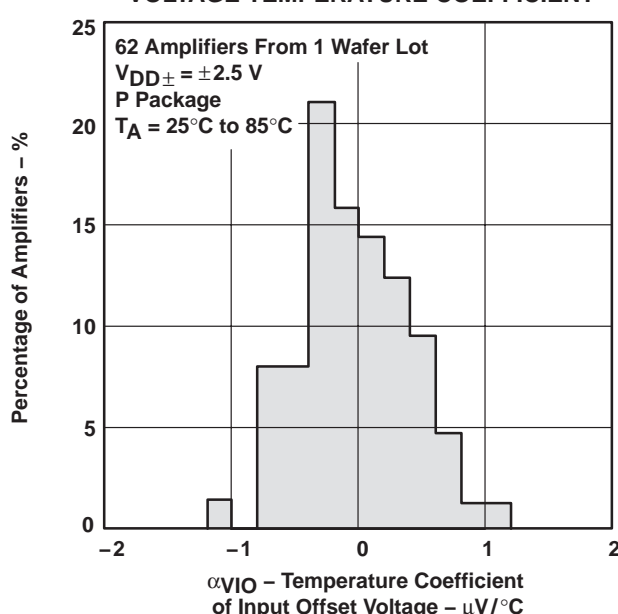

**Figure 11**

**INPUT BIAS AND INPUT OFFSET CURRENTS† VS FREE-AIR TEMPERATURE**

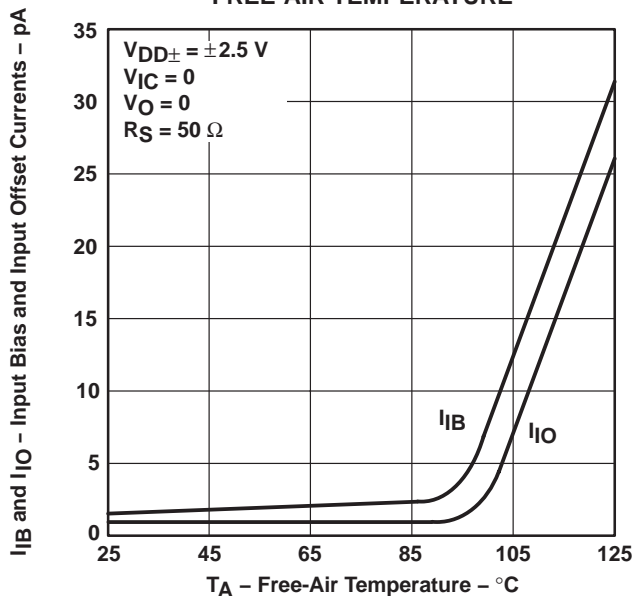

**Figure 12**

**INPUT VOLTAGE vs SUPPLY VOLTAGE**

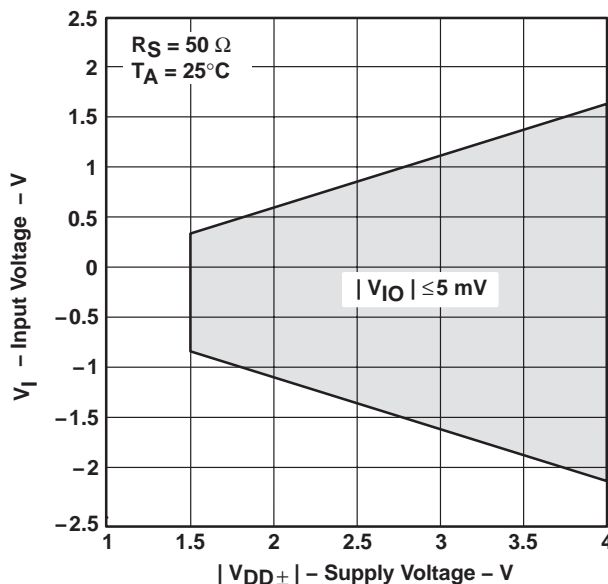
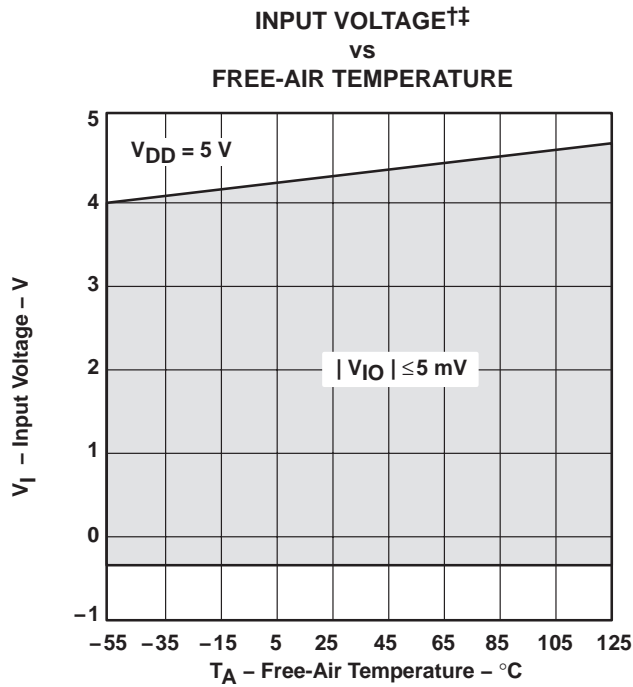

**Figure 13**

† Data at high and low temperatures are applicable only within the rated operating free-air temperature ranges of the various devices.



**TYPICAL CHARACTERISTICS**



**Figure 14**

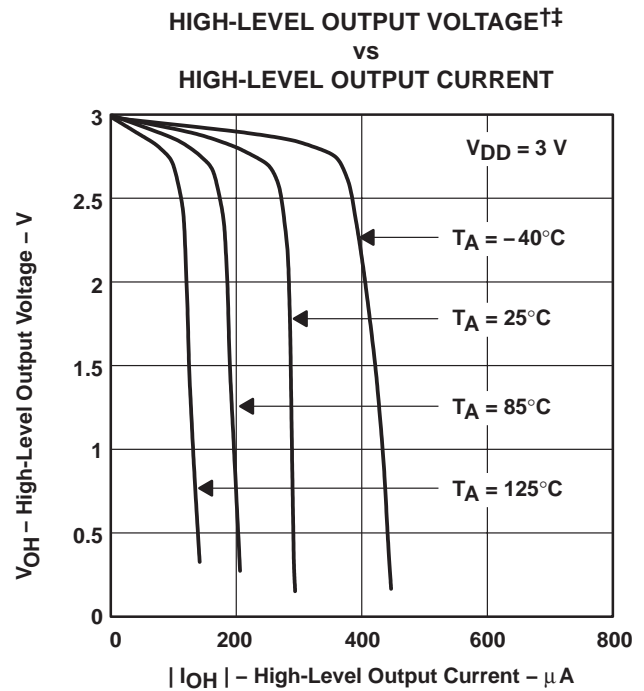

**Figure 15**

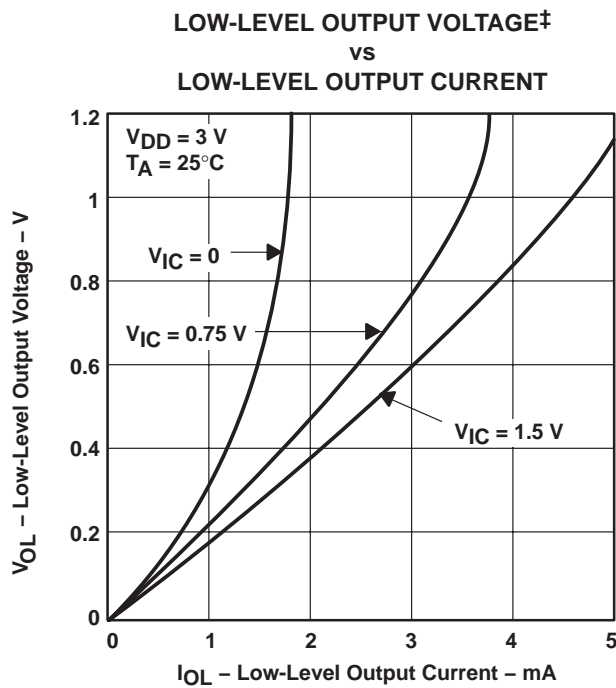

**Figure 16**

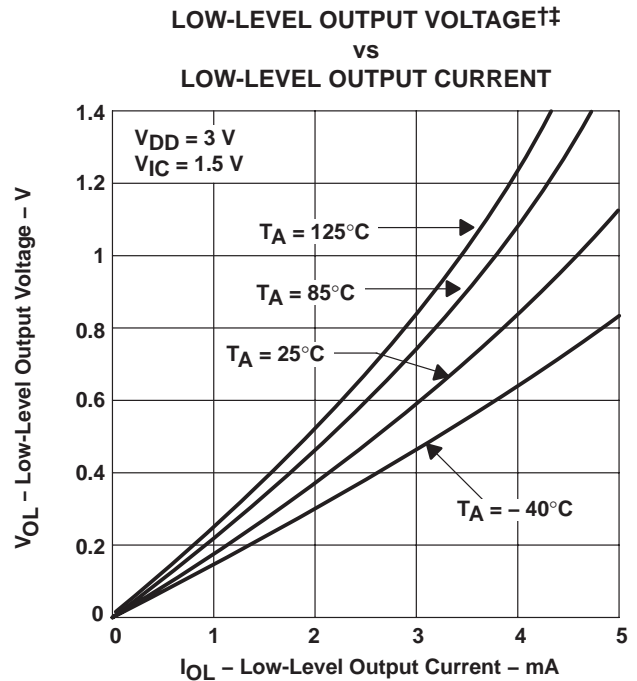

**Figure 17**

† Data at high and low temperatures are applicable only within the rated operating free-air temperature ranges of the various devices.  
 ‡ For all curves where  $V_{DD} = 5\text{ V}$ , all loads are referenced to 2.5 V. For all curves where  $V_{DD} = 3\text{ V}$ , all loads are referenced to 1.5 V.

**TYPICAL CHARACTERISTICS**

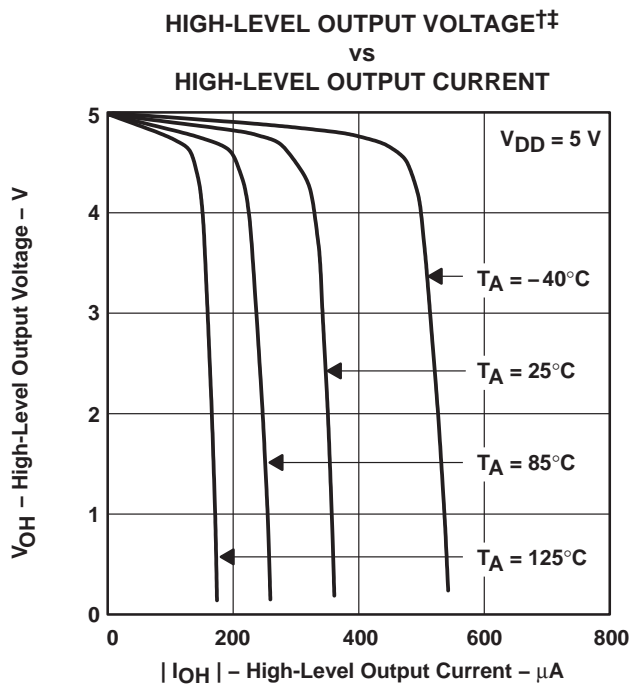

**Figure 18**

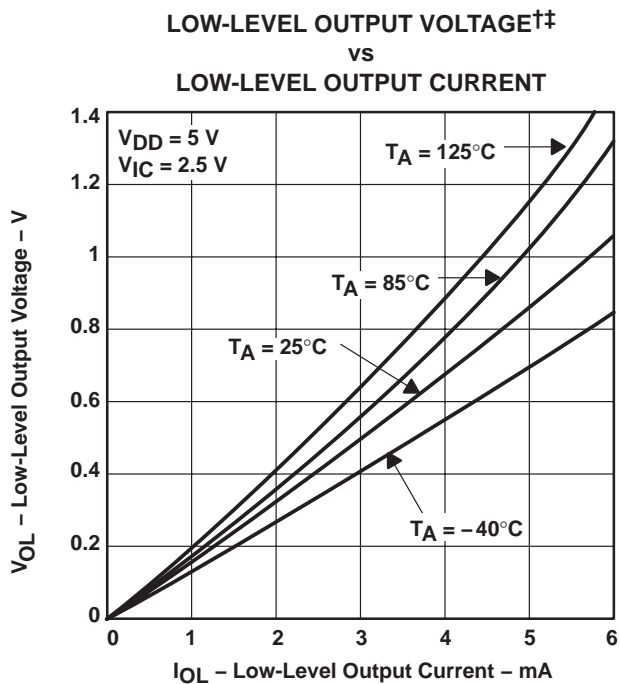

**Figure 19**

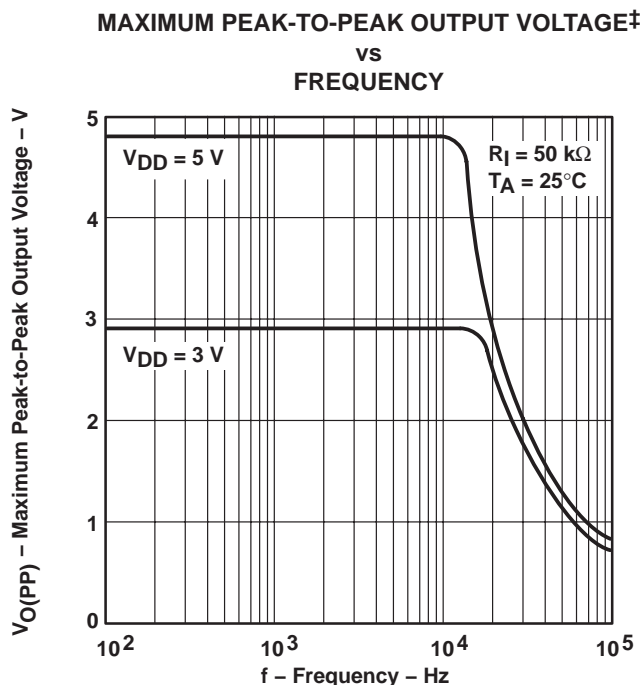

**Figure 20**

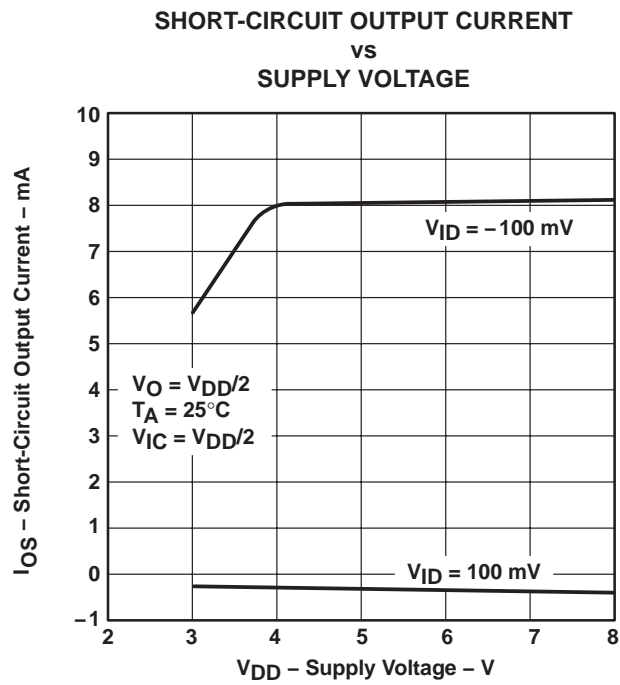

**Figure 21**

† Data at high and low temperatures are applicable only within the rated operating free-air temperature ranges of the various devices.  
 ‡ For all curves where  $V_{DD} = 5 V$ , all loads are referenced to 2.5 V. For all curves where  $V_{DD} = 3 V$ , all loads are referenced to 1.5 V.

TYPICAL CHARACTERISTICS

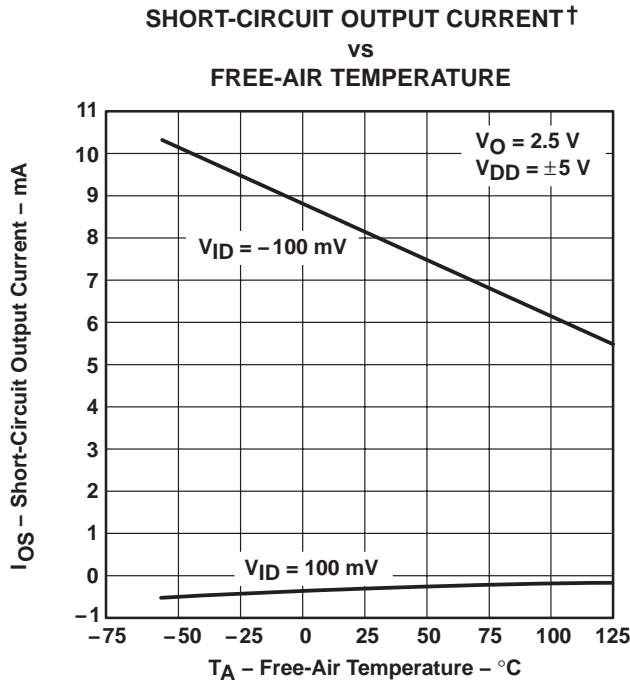

Figure 22

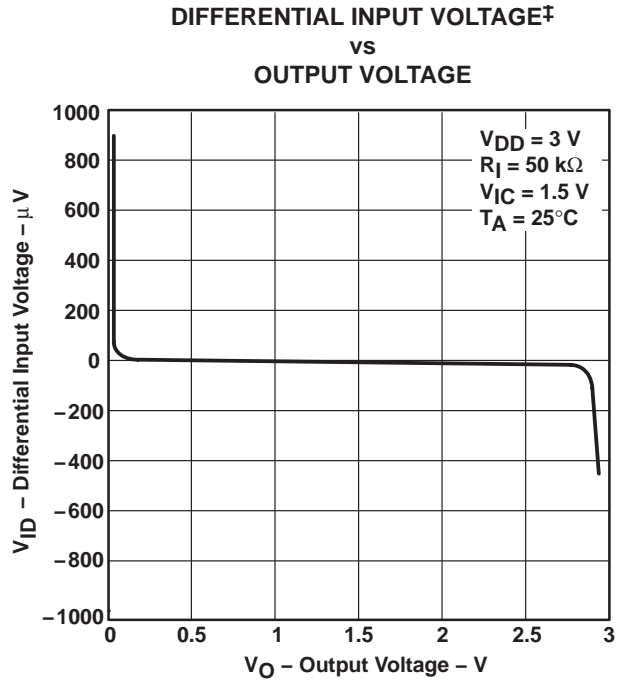

Figure 23

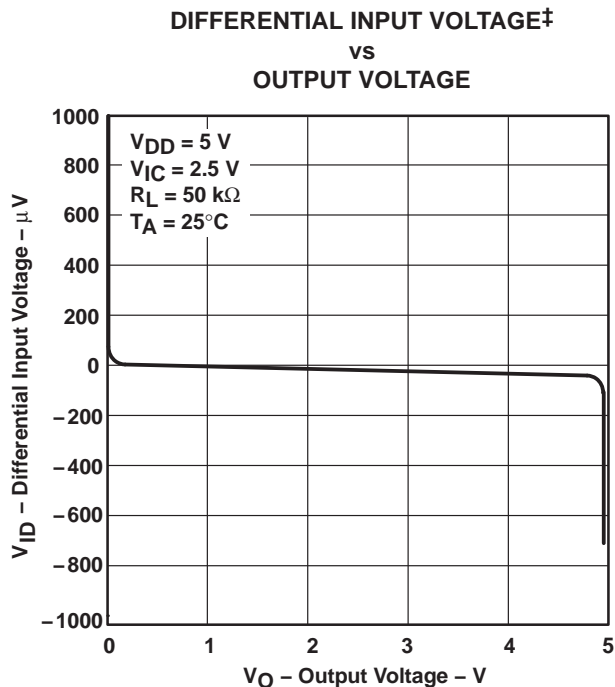

Figure 24

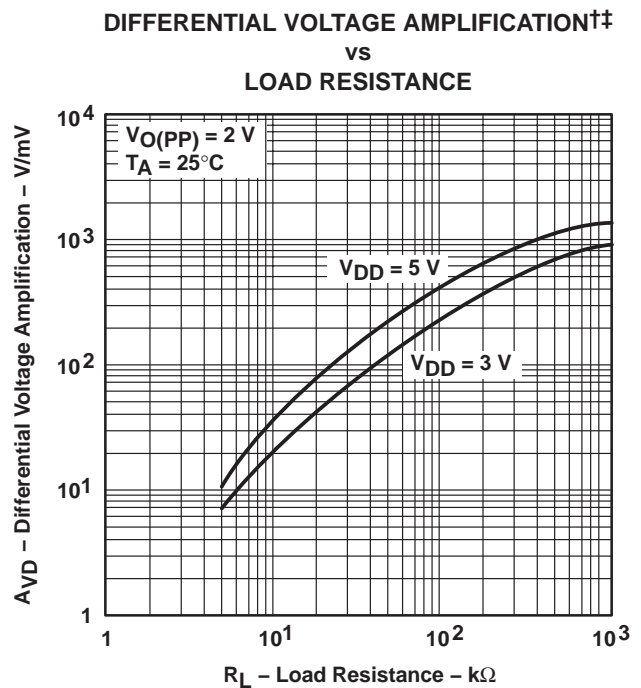

Figure 25

† Data at high and low temperatures are applicable only within the rated operating free-air temperature ranges of the various devices.

‡ For all curves where  $V_{DD} = 5 \text{ V}$ , all loads are referenced to 2.5 V. For all curves where  $V_{DD} = 3 \text{ V}$ , all loads are referenced to 1.5 V.

**TLV225x-EP, TLV225xA-EP**  
**Advanced LinCMOS™ RAIL-TO-RAIL**  
**VERY LOW-POWER OPERATIONAL AMPLIFIERS**

SGLS217B – NOVEMBER 2003 – REVISED JUNE 2006

**TYPICAL CHARACTERISTICS**

**LARGE-SIGNAL DIFFERENTIAL VOLTAGE†  
 AMPLIFICATION AND PHASE MARGIN**

**vs  
 FREQUENCY**

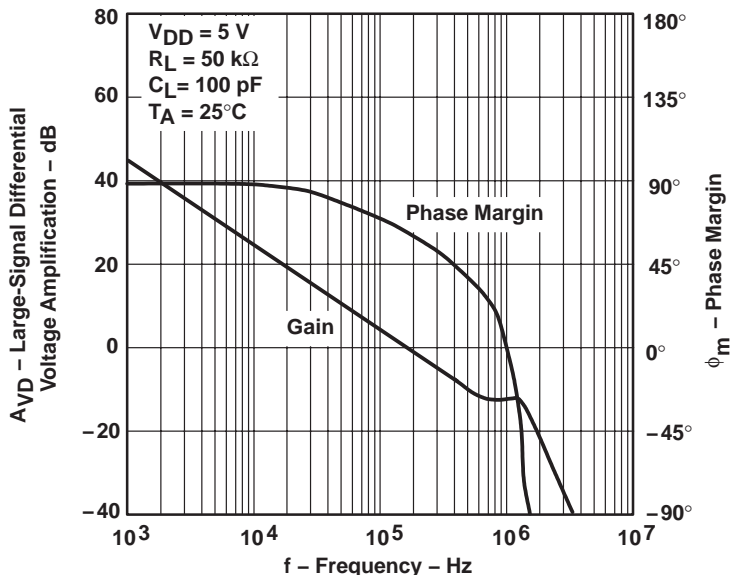

**Figure 26**

**LARGE-SIGNAL DIFFERENTIAL VOLTAGE†  
 AMPLIFICATION AND PHASE MARGIN**

**vs  
 FREQUENCY**

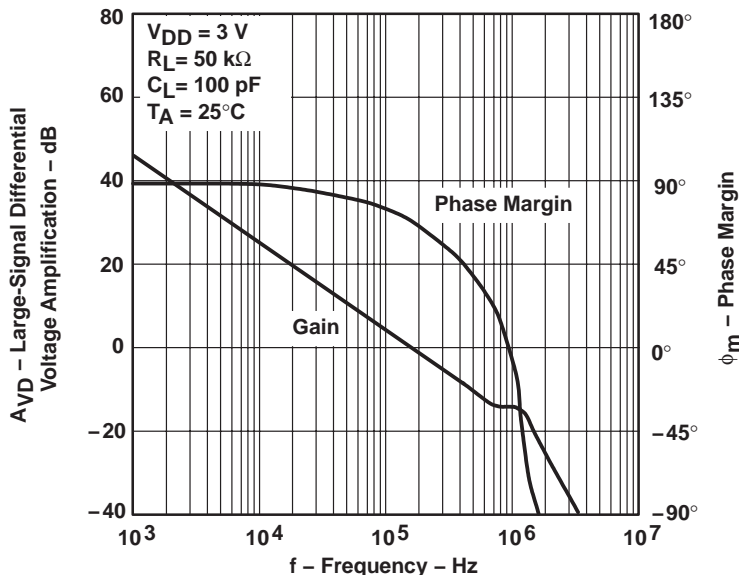

**Figure 27**

† For all curves where  $V_{DD} = 5\text{ V}$ , all loads are referenced to 2.5 V. For all curves where  $V_{DD} = 3\text{ V}$ , all loads are referenced to 1.5 V.



TYPICAL CHARACTERISTICS

LARGE-SIGNAL DIFFERENTIAL†  
 VOLTAGE AMPLIFICATION  
 vs  
 FREE-AIR TEMPERATURE

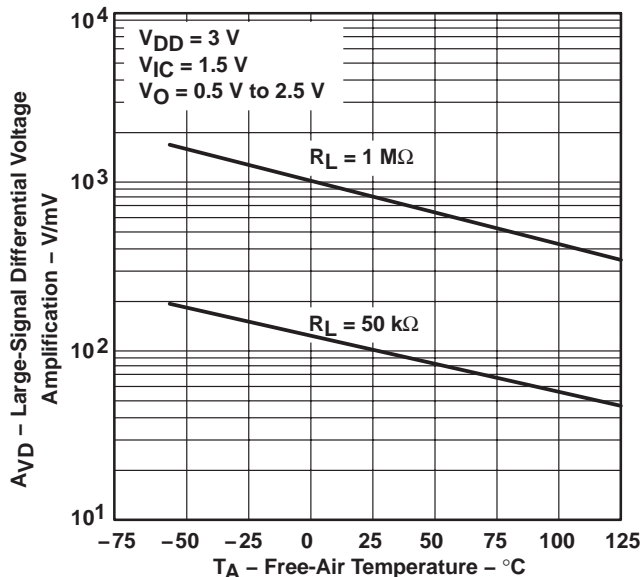

Figure 28

LARGE-SIGNAL DIFFERENTIAL†  
 VOLTAGE AMPLIFICATION  
 vs  
 FREE-AIR TEMPERATURE

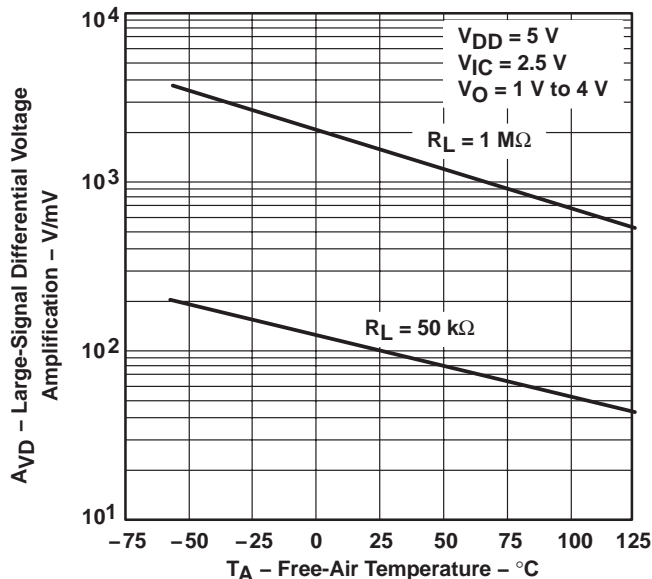

Figure 29

OUTPUT IMPEDANCE‡  
 vs  
 FREQUENCY

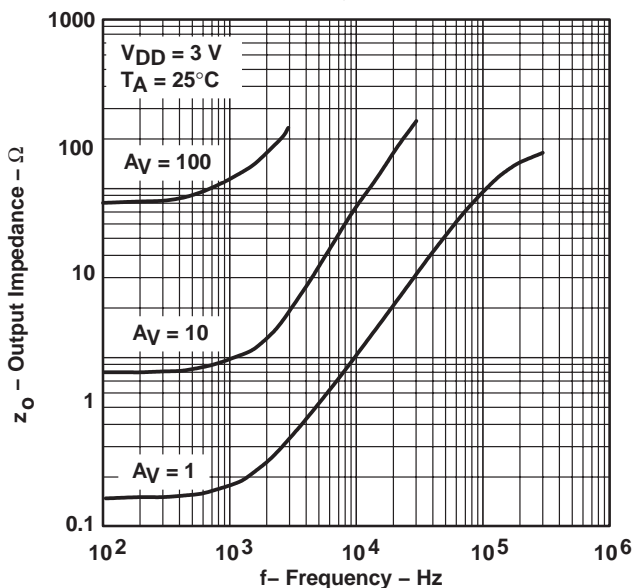

Figure 30

OUTPUT IMPEDANCE‡  
 vs  
 FREQUENCY

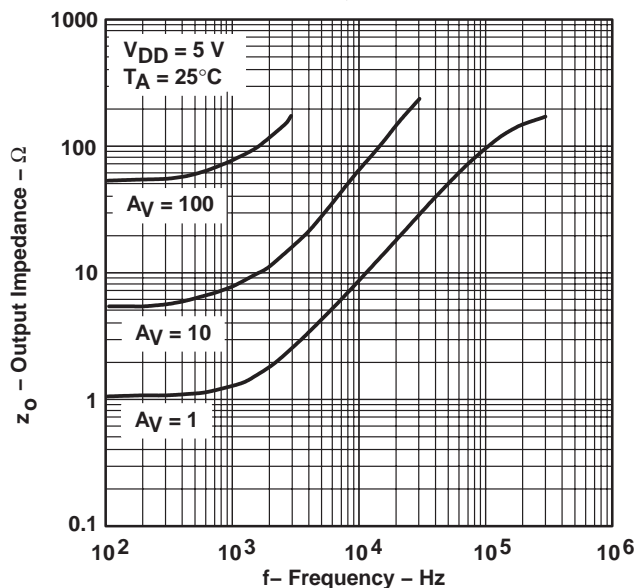
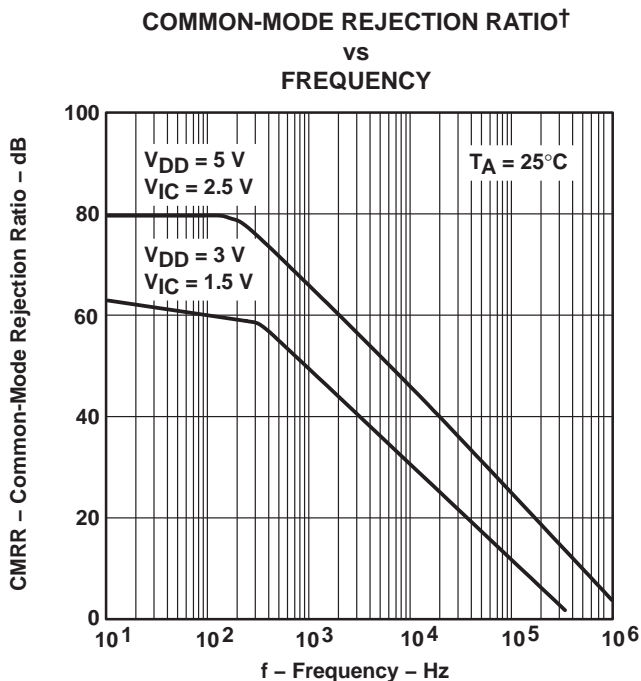

Figure 31

† Data at high and low temperatures are applicable only within the rated operating free-air temperature ranges of the various devices.

‡ For all curves where  $V_{DD} = 5\text{ V}$ , all loads are referenced to  $2.5\text{ V}$ . For all curves where  $V_{DD} = 3\text{ V}$ , all loads are referenced to  $1.5\text{ V}$ .

**TYPICAL CHARACTERISTICS**



**Figure 32**

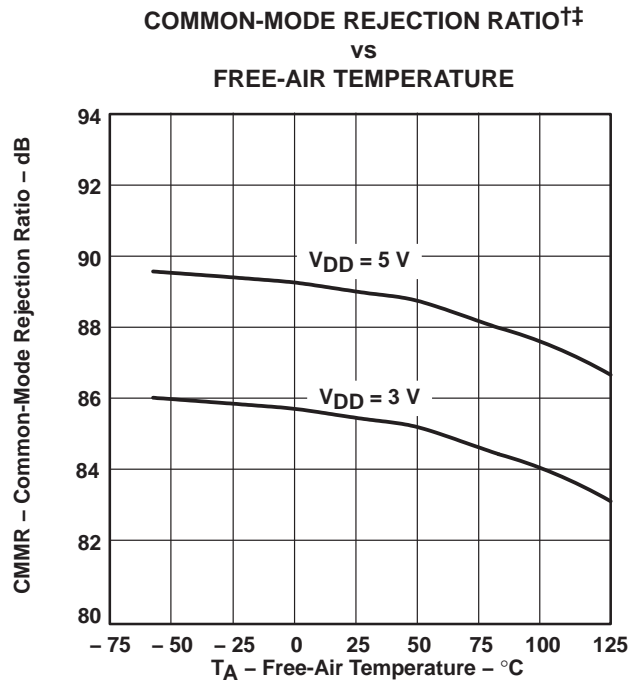

**Figure 33**

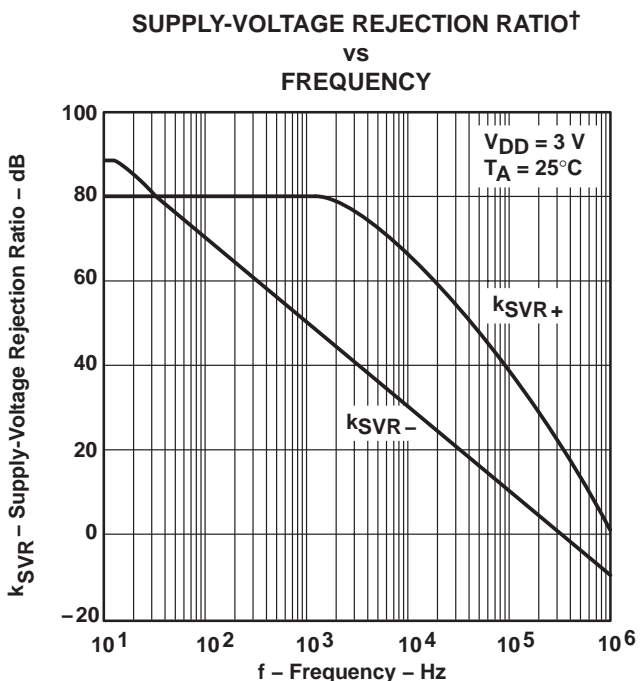

**Figure 34**

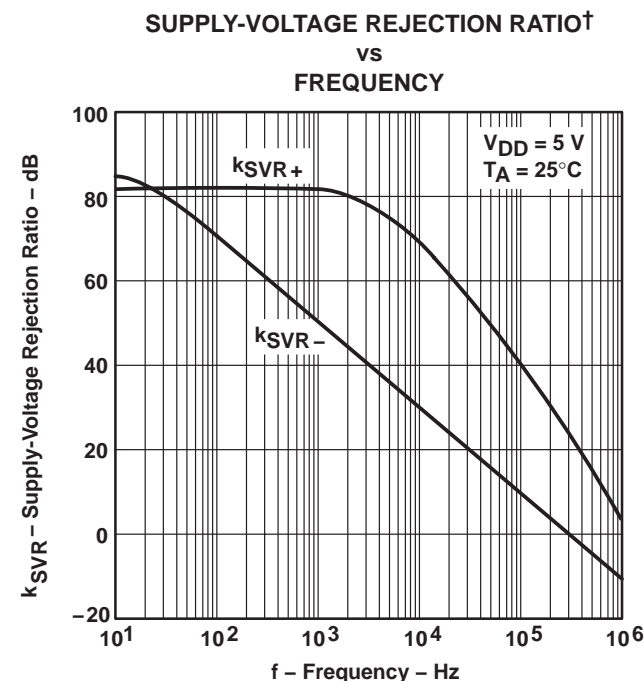

**Figure 35**

† For all curves where  $V_{DD} = 5\text{ V}$ , all loads are referenced to 2.5 V. For all curves where  $V_{DD} = 3\text{ V}$ , all loads are referenced to 1.5 V.  
 ‡ Data at high and low temperatures are applicable only within the rated operating free-air temperature ranges of the various devices.

**TYPICAL CHARACTERISTICS**

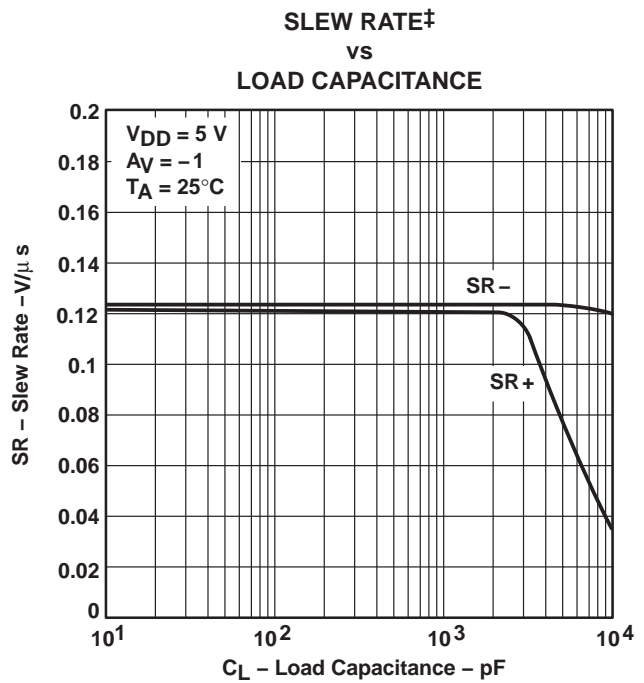
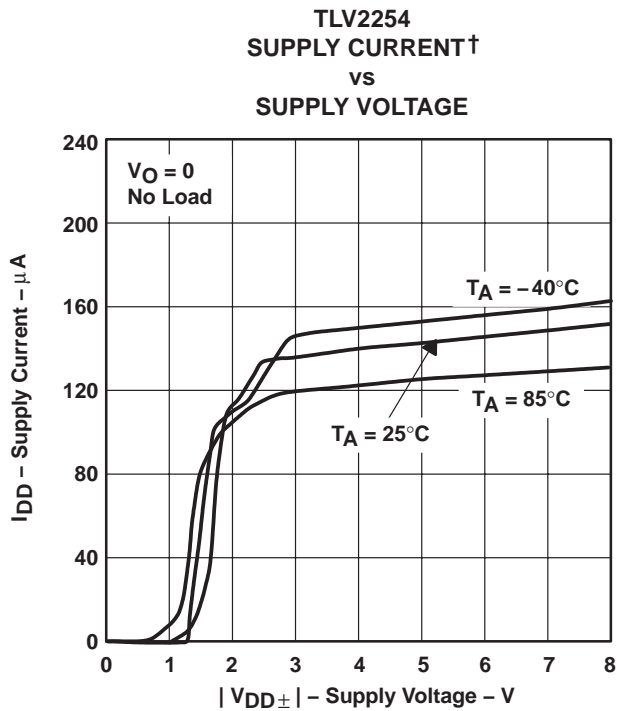
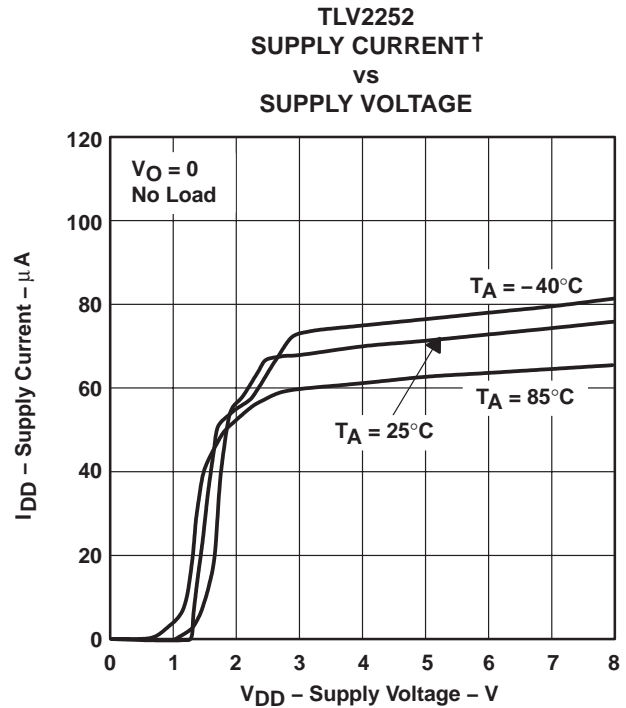
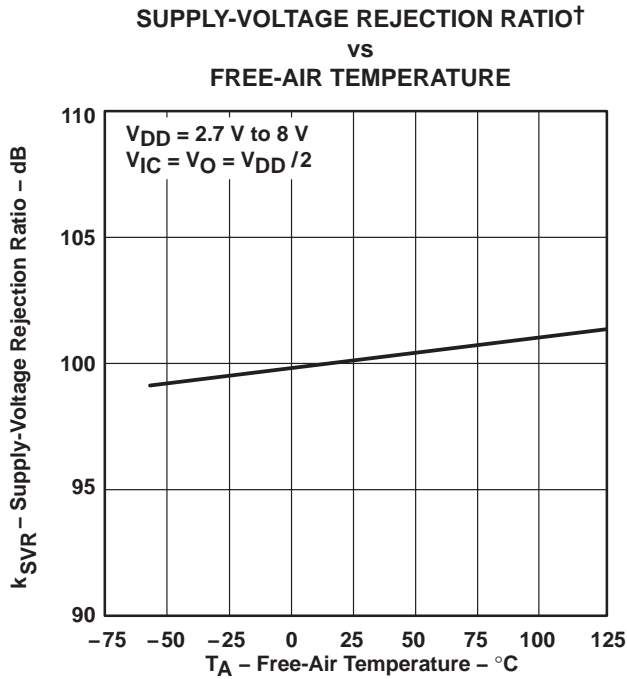

† Data at high and low temperatures are applicable only within the rated operating free-air temperature ranges of the various devices.

‡ For all curves where  $V_{DD} = 5$  V, all loads are referenced to 2.5 V. For all curves where  $V_{DD} = 3$  V, all loads are referenced to 1.5 V.

**TLV225x-EP, TLV225xA-EP**  
**Advanced LinCMOS™ RAIL-TO-RAIL**  
**VERY LOW-POWER OPERATIONAL AMPLIFIERS**

SGLS217B – NOVEMBER 2003 – REVISED JUNE 2006

**TYPICAL CHARACTERISTICS**

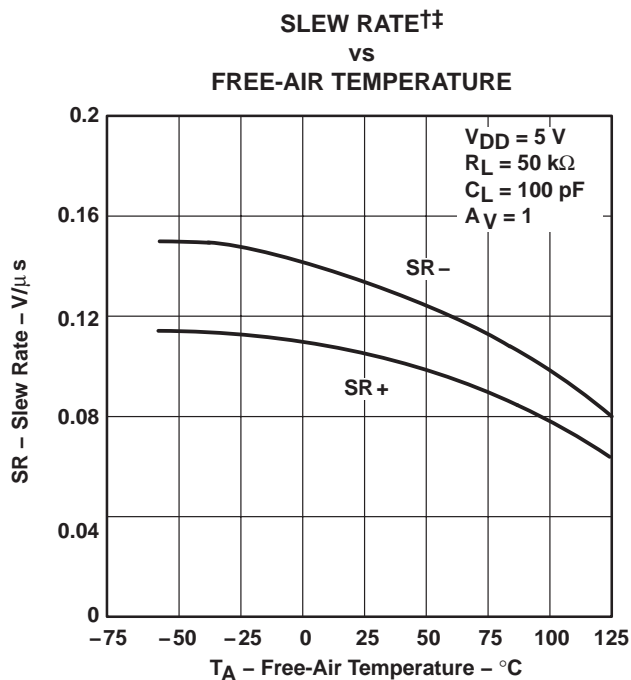

**Figure 40**

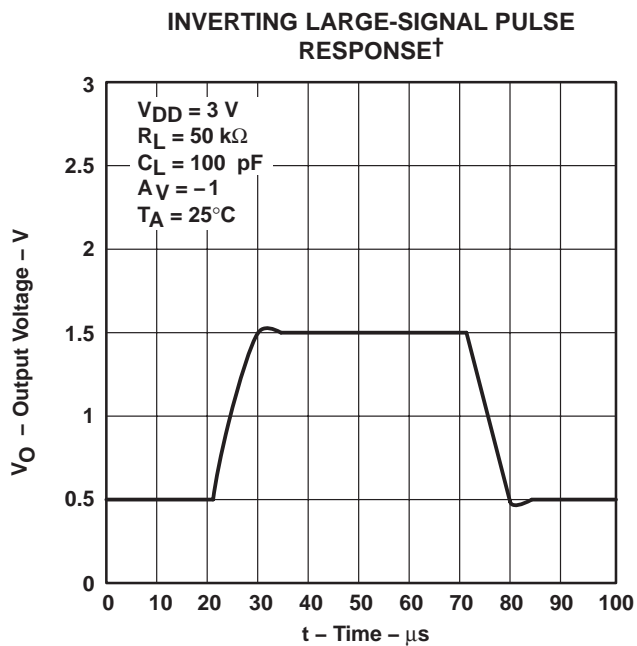

**Figure 41**

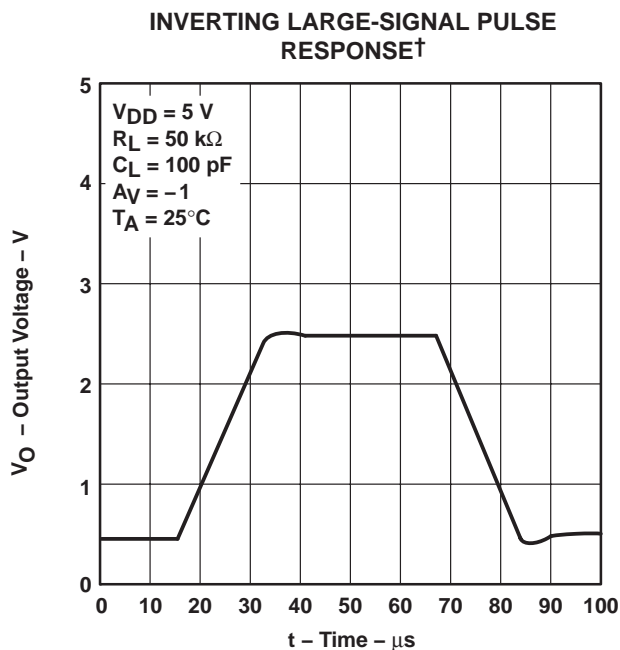

**Figure 42**

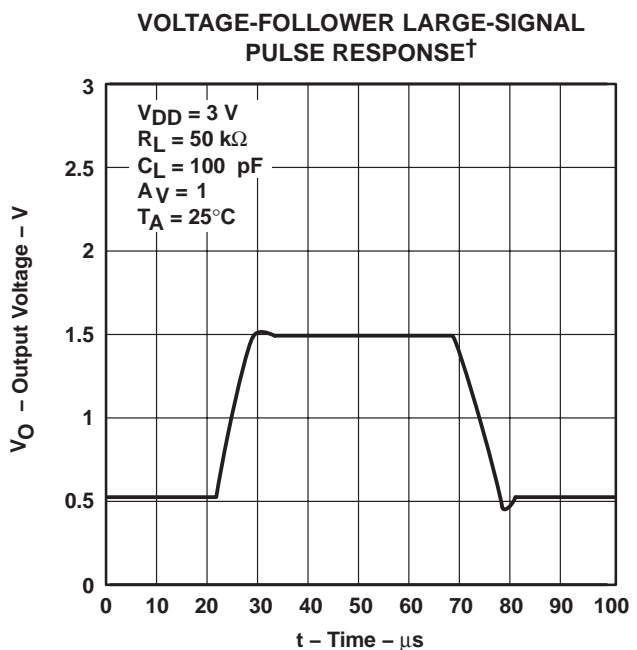

**Figure 43**

† Data at high and low temperatures are applicable only within the rated operating free-air temperature ranges of the various devices.  
 ‡ For all curves where  $V_{DD} = 5\text{ V}$ , all loads are referenced to 2.5 V. For all curves where  $V_{DD} = 3\text{ V}$ , all loads are referenced to 1.5 V.





**TYPICAL CHARACTERISTICS**

**VOLTAGE-FOLLOWER LARGE-SIGNAL PULSE RESPONSE†**

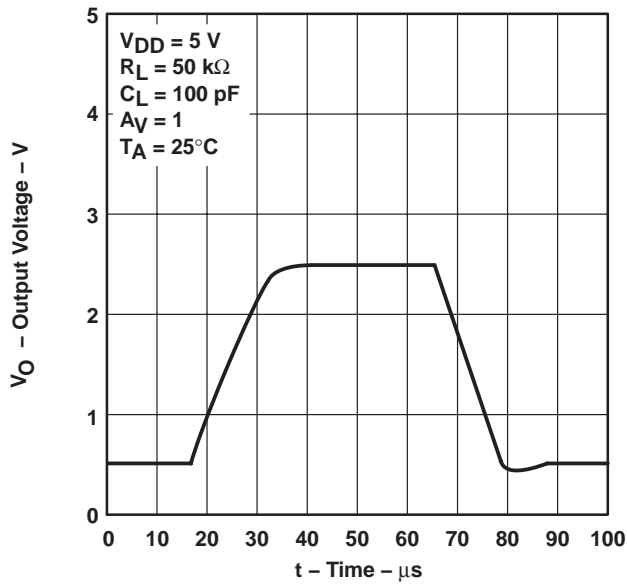

**Figure 44**

**INVERTING SMALL-SIGNAL PULSE RESPONSE†**

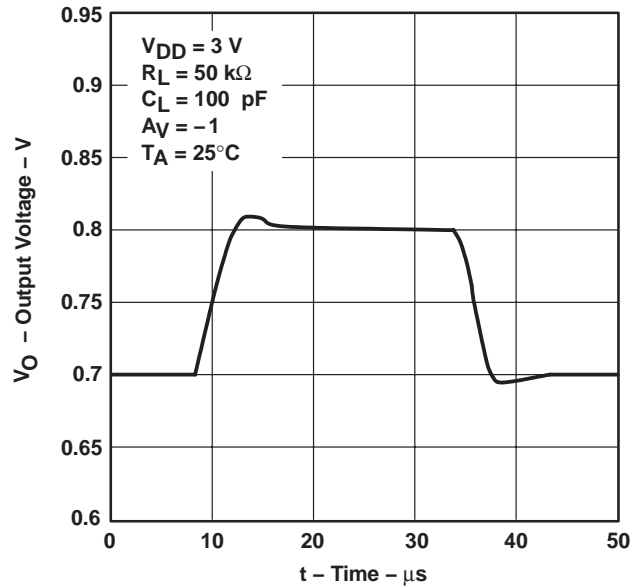

**Figure 45**

**INVERTING SMALL-SIGNAL PULSE RESPONSE†**

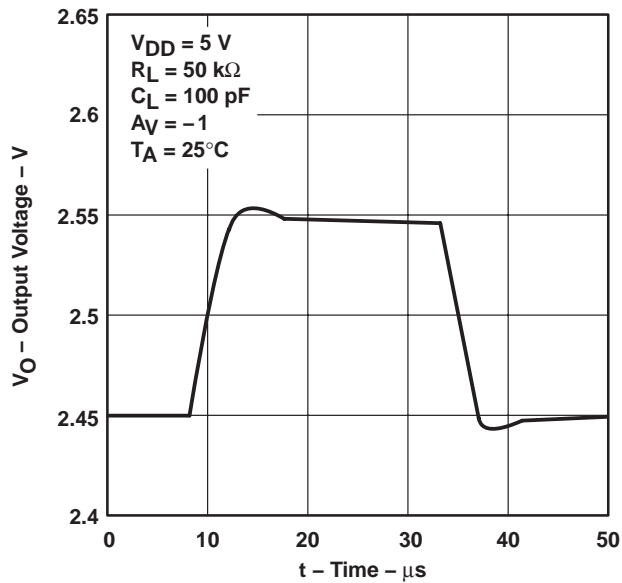

**Figure 46**

**VOLTAGE-FOLLOWER SMALL-SIGNAL PULSE RESPONSE†**

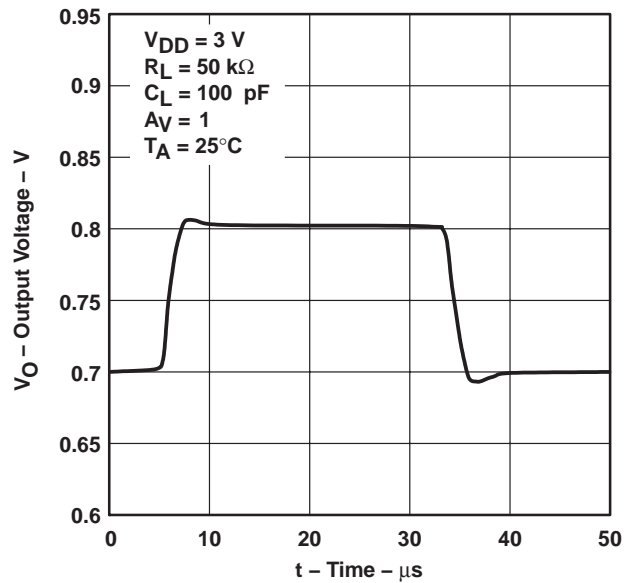

**Figure 47**

† For all curves where  $V_{DD} = 5\text{ V}$ , all loads are referenced to 2.5 V. For all curves where  $V_{DD} = 3\text{ V}$ , all loads are referenced to 1.5 V.

**TLV225x-EP, TLV225xA-EP**  
**Advanced LinCMOS™ RAIL-TO-RAIL**  
**VERY LOW-POWER OPERATIONAL AMPLIFIERS**

SGLS217B – NOVEMBER 2003 – REVISED JUNE 2006

**TYPICAL CHARACTERISTICS**

**VOLTAGE-FOLLOWER SMALL-SIGNAL PULSE RESPONSE†**

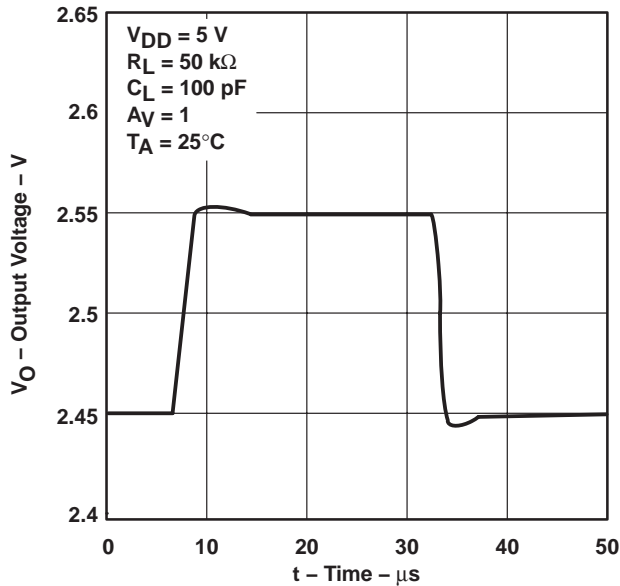

**Figure 48**

**EQUIVALENT INPUT NOISE VOLTAGE† VS FREQUENCY**

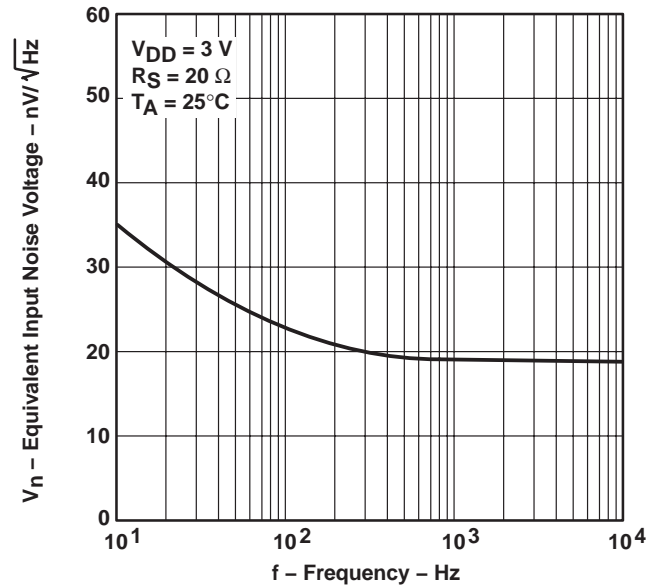

**Figure 49**

**EQUIVALENT INPUT NOISE VOLTAGE† VS FREQUENCY**

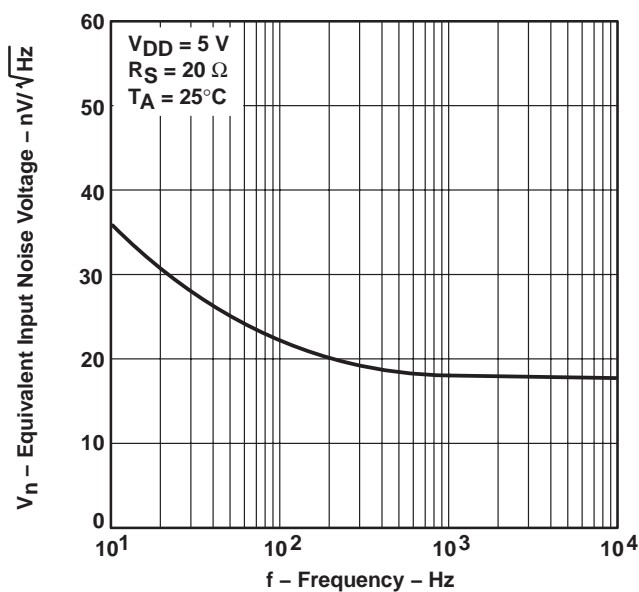

**Figure 50**

**INPUT NOISE VOLTAGE OVER A 10-s PERIOD†**

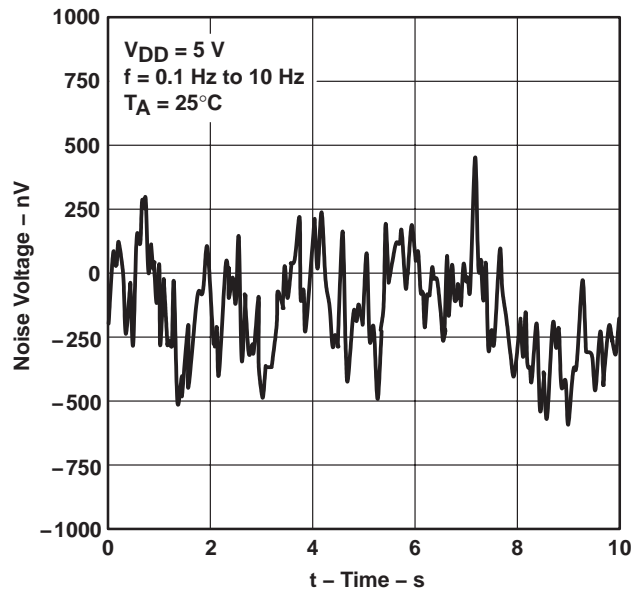

**Figure 51**

† For all curves where  $V_{DD} = 5\text{ V}$ , all loads are referenced to 2.5 V. For all curves where  $V_{DD} = 3\text{ V}$ , all loads are referenced to 1.5 V.

TYPICAL CHARACTERISTICS

INTEGRATED NOISE VOLTAGE†  
 vs  
 FREQUENCY

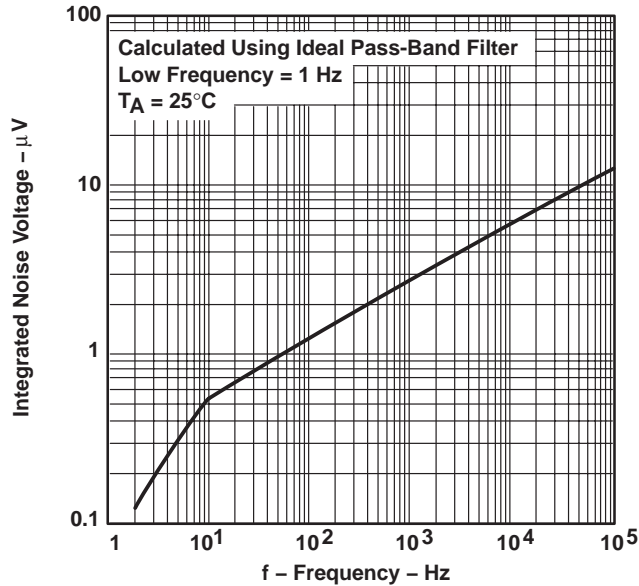

Figure 52

TOTAL HARMONIC DISTORTION PLUS NOISE†  
 vs  
 FREQUENCY

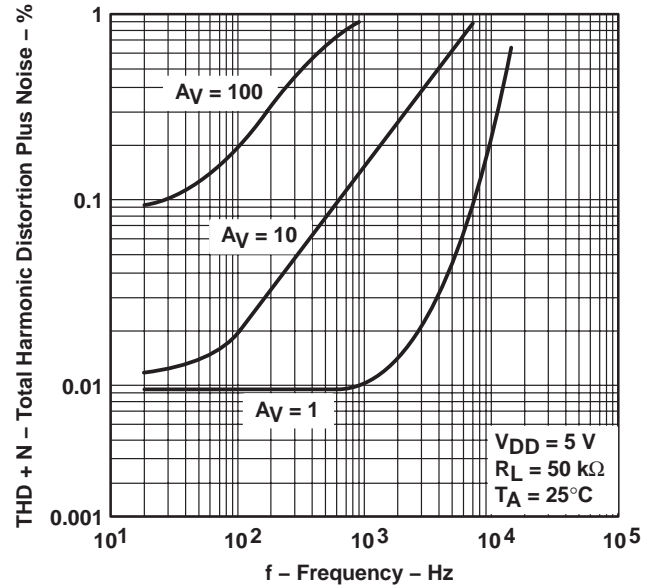

Figure 53

GAIN-BANDWIDTH PRODUCT  
 vs  
 SUPPLY VOLTAGE

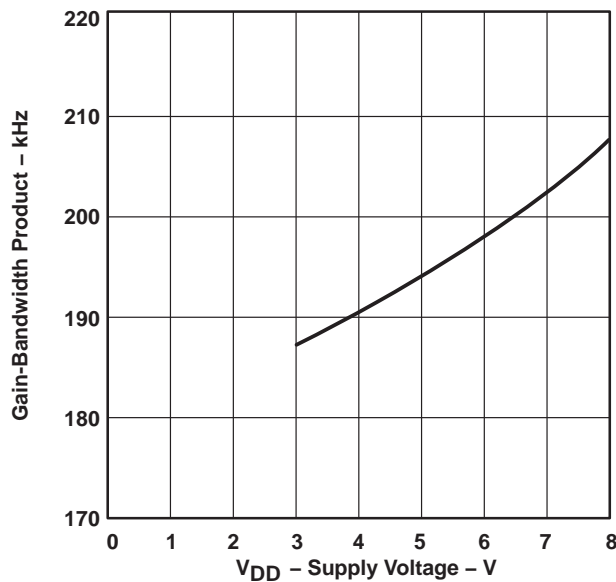

Figure 54

GAIN-BANDWIDTH PRODUCT††  
 vs  
 FREE-AIR TEMPERATURE

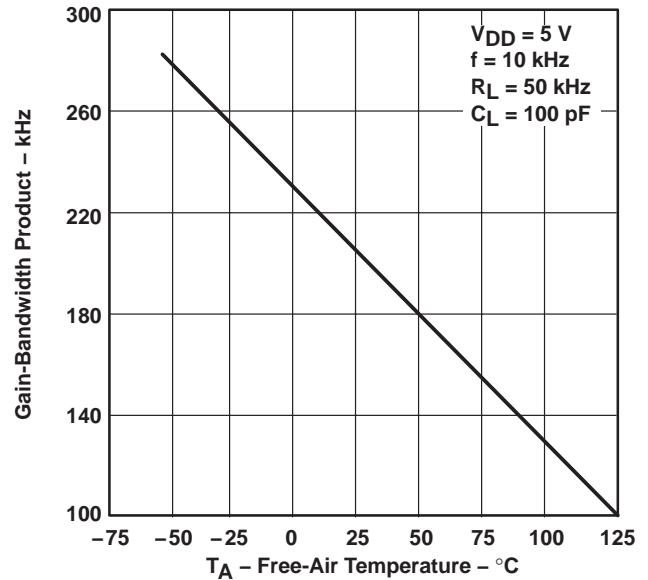
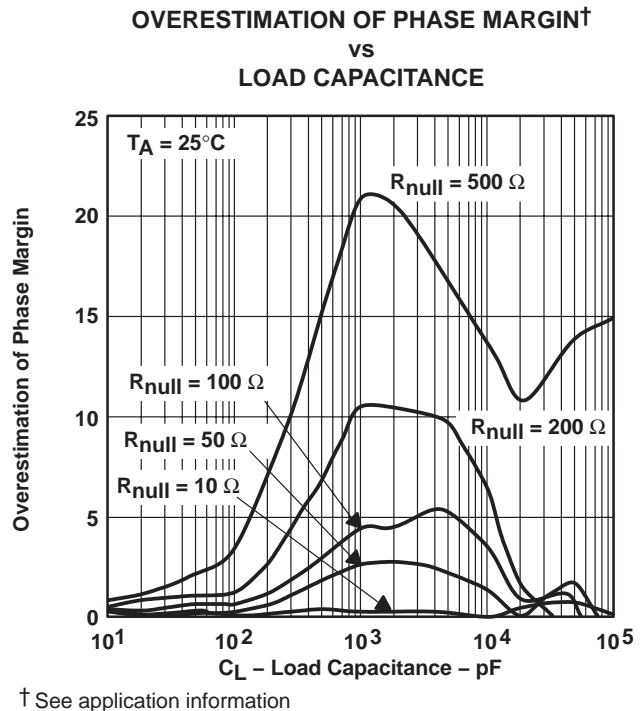
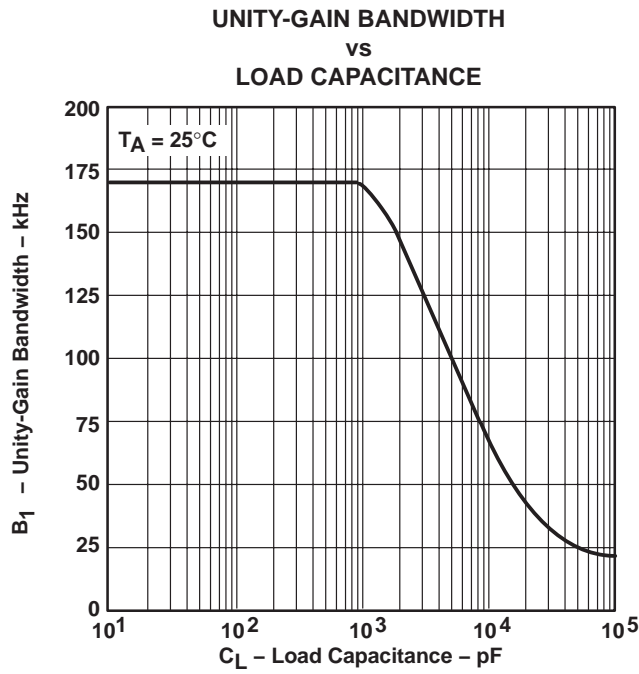
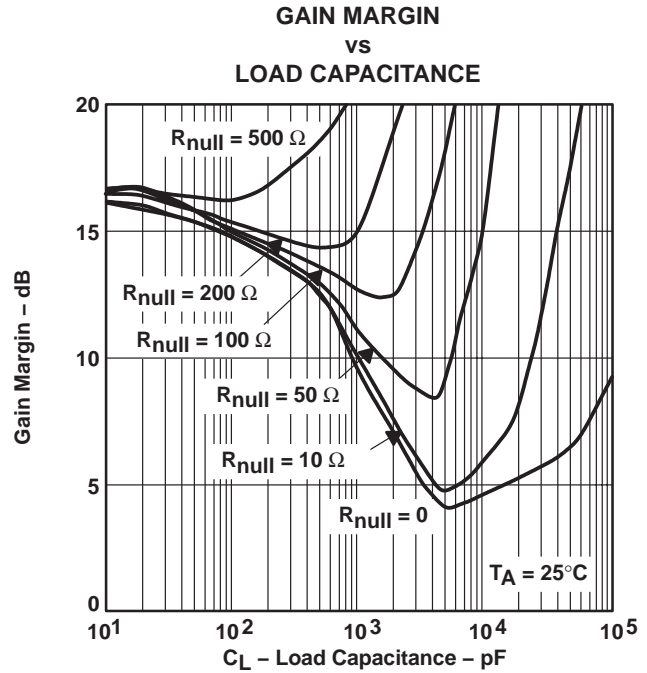
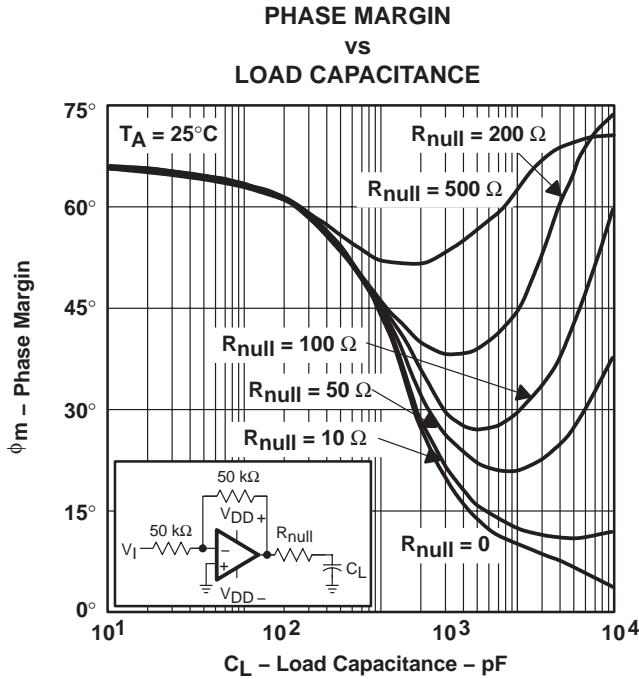

Figure 55

† For all curves where  $V_{DD} = 5\text{ V}$ , all loads are referenced to  $2.5\text{ V}$ . For all curves where  $V_{DD} = 3\text{ V}$ , all loads are referenced to  $1.5\text{ V}$ .

**TYPICAL CHARACTERISTICS**



† For all curves where  $V_{DD} = 5\text{ V}$ , all loads are referenced to  $2.5\text{ V}$ . For all curves where  $V_{DD} = 3\text{ V}$ , all loads are referenced to  $1.5\text{ V}$ .

‡ Data at high and low temperatures are applicable only within the rated operating free-air temperature ranges of the various devices.

## APPLICATION INFORMATION

### driving large capacitive loads

The TLV2252 is designed to drive larger capacitive loads than most CMOS operational amplifiers. Figure 56 and Figure 57 illustrate its ability to drive loads up to 1000 pF while maintaining good gain and phase margins ( $R_{null} = 0$ ).

A smaller series resistor ( $R_{null}$ ) at the output of the device (see Figure 60) improves the gain and phase margins when driving large capacitive loads. Figure 55 and Figure 56 show the effects of adding series resistances of 10  $\Omega$ , 50  $\Omega$ , 100  $\Omega$ , 200  $\Omega$ , and 500  $\Omega$ . The addition of this series resistor has two effects – the first adds a zero to the transfer function and the second reduces the frequency of the pole associated with the output load in the transfer function.

The zero introduced to the transfer function is equal to the series resistance times the load capacitance. To calculate the improvement in phase margin, equation 1 can be used.

$$\Delta\phi_{m1} = \tan^{-1} \left( 2 \times \pi \times \text{UGBW} \times R_{null} \times C_L \right) \quad (1)$$

Where :

- $\Delta\phi_{m1}$  = improvement in phase margin
- UGBW = unity-gain bandwidth frequency
- $R_{null}$  = output series resistance
- $C_L$  = load capacitance

The unity-gain bandwidth (UGBW) frequency decreases as the capacitive load increases (see Figure 58). To use equation 1, UGBW must be approximated from Figure 58.

Using equation 1 alone overestimates the improvement in phase margin as illustrated in Figure 59. The overestimation is caused by the decrease in the frequency of the pole associated with the load, providing additional phase shift and reducing the overall improvement in phase margin.

Using Figure 60, with equation 1 enables the designer to choose the appropriate output series resistance to optimize the design of circuits driving large capacitance loads.

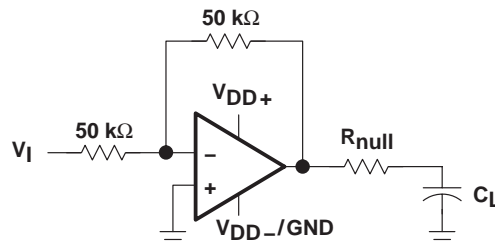

**Figure 60. Series-Resistance Circuit**

**TLV225x-EP, TLV225xA-EP**  
**Advanced LinCMOS™ RAIL-TO-RAIL**  
**VERY LOW-POWER OPERATIONAL AMPLIFIERS**

SGLS217B – NOVEMBER 2003 – REVISED JUNE 2006

**APPLICATION INFORMATION**

**macromodel information**

Macromodel information provided was derived using Microsim *Parts*™, the model generation software used with Microsim *PSpice*™. The Boyle macromodel (see Note 5) and subcircuit in Figure 61 are generated using the TLV2252 typical electrical and operating characteristics at  $T_A = 25^\circ\text{C}$ . Using this information, output simulations of the following key parameters can be generated to a tolerance of 20% (in most cases):

- Maximum positive output voltage swing
- Maximum negative output voltage swing
- Slew rate
- Quiescent power dissipation
- Input bias current
- Open-loop voltage amplification
- Unity-gain frequency
- Common-mode rejection ratio
- Phase margin
- DC output resistance
- AC output resistance
- Short-circuit output current limit

NOTE 4: G. R. Boyle, B. M. Cohn, D. O. Pederson, and J. E. Solomon, "Macromodeling of Integrated Circuit Operational Amplifiers," *IEEE Journal of Solid-State Circuits*, SC-9, 353 (1974).

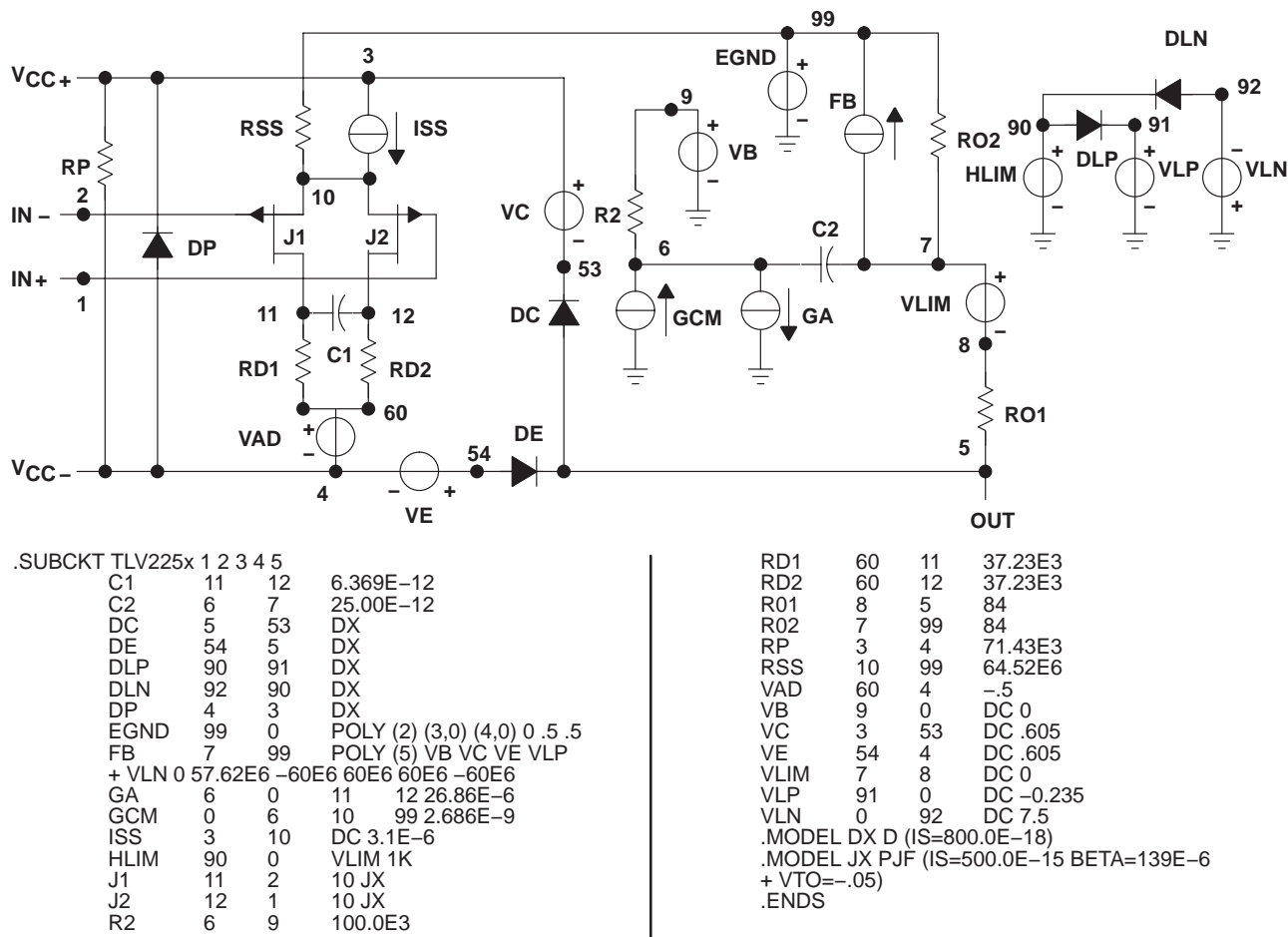

**Figure 61. Boyle Macromodel and Subcircuit**

*PSpice* and *Parts* are trademarks of MicroSim Corporation.



## PACKAGING INFORMATION

| Orderable Device | Status<br>(1) | Package Type | Package Drawing | Pins | Package Qty | Eco Plan<br>(2)         | Lead/Ball Finish<br>(6) | MSL Peak Temp<br>(3) | Op Temp (°C) | Device Marking<br>(4/5) | Samples                 |
|------------------|---------------|--------------|-----------------|------|-------------|-------------------------|-------------------------|----------------------|--------------|-------------------------|-------------------------|
| TLV2252AQDREP    | ACTIVE        | SOIC         | D               | 8    | 2500        | Green (RoHS & no Sb/Br) | CU NIPDAU               | Level-1-260C-UNLIM   | -40 to 125   | 2252AE                  | <a href="#">Samples</a> |
| TLV2254AQDREP    | ACTIVE        | SOIC         | D               | 14   | 2500        | Green (RoHS & no Sb/Br) | CU NIPDAU               | Level-1-260C-UNLIM   | -40 to 125   | TLV2254AEP              | <a href="#">Samples</a> |
| V62/04651-02UE   | ACTIVE        | SOIC         | D               | 8    | 2500        | Green (RoHS & no Sb/Br) | CU NIPDAU               | Level-1-260C-UNLIM   | -40 to 125   | 2252AE                  | <a href="#">Samples</a> |
| V62/04651-04XE   | ACTIVE        | SOIC         | D               | 14   | 2500        | Green (RoHS & no Sb/Br) | CU NIPDAU               | Level-1-260C-UNLIM   | -40 to 125   | TLV2254AEP              | <a href="#">Samples</a> |

(1) The marketing status values are defined as follows:

**ACTIVE:** Product device recommended for new designs.

**LIFEBUY:** TI has announced that the device will be discontinued, and a lifetime-buy period is in effect.

**NRND:** Not recommended for new designs. Device is in production to support existing customers, but TI does not recommend using this part in a new design.

**PREVIEW:** Device has been announced but is not in production. Samples may or may not be available.

**OBSELETE:** TI has discontinued the production of the device.

(2) Eco Plan - The planned eco-friendly classification: Pb-Free (RoHS), Pb-Free (RoHS Exempt), or Green (RoHS & no Sb/Br) - please check <http://www.ti.com/productcontent> for the latest availability information and additional product content details.

**TBD:** The Pb-Free/Green conversion plan has not been defined.

**Pb-Free (RoHS):** TI's terms "Lead-Free" or "Pb-Free" mean semiconductor products that are compatible with the current RoHS requirements for all 6 substances, including the requirement that lead not exceed 0.1% by weight in homogeneous materials. Where designed to be soldered at high temperatures, TI Pb-Free products are suitable for use in specified lead-free processes.

**Pb-Free (RoHS Exempt):** This component has a RoHS exemption for either 1) lead-based flip-chip solder bumps used between the die and package, or 2) lead-based die adhesive used between the die and leadframe. The component is otherwise considered Pb-Free (RoHS compatible) as defined above.

**Green (RoHS & no Sb/Br):** TI defines "Green" to mean Pb-Free (RoHS compatible), and free of Bromine (Br) and Antimony (Sb) based flame retardants (Br or Sb do not exceed 0.1% by weight in homogeneous material)

(3) MSL, Peak Temp. - The Moisture Sensitivity Level rating according to the JEDEC industry standard classifications, and peak solder temperature.

(4) There may be additional marking, which relates to the logo, the lot trace code information, or the environmental category on the device.

(5) Multiple Device Markings will be inside parentheses. Only one Device Marking contained in parentheses and separated by a "~" will appear on a device. If a line is indented then it is a continuation of the previous line and the two combined represent the entire Device Marking for that device.

(6) Lead/Ball Finish - Orderable Devices may have multiple material finish options. Finish options are separated by a vertical ruled line. Lead/Ball Finish values may wrap to two lines if the finish value exceeds the maximum column width.

**Important Information and Disclaimer:**The information provided on this page represents TI's knowledge and belief as of the date that it is provided. TI bases its knowledge and belief on information provided by third parties, and makes no representation or warranty as to the accuracy of such information. Efforts are underway to better integrate information from third parties. TI has taken and continues to take reasonable steps to provide representative and accurate information but may not have conducted destructive testing or chemical analysis on incoming materials and chemicals. TI and TI suppliers consider certain information to be proprietary, and thus CAS numbers and other limited information may not be available for release.

In no event shall TI's liability arising out of such information exceed the total purchase price of the TI part(s) at issue in this document sold by TI to Customer on an annual basis.

**OTHER QUALIFIED VERSIONS OF TLV2252-EP, TLV2252A-EP, TLV2254-EP, TLV2254A-EP :**

- Catalog: [TLV2252](#), [TLV2252A](#), [TLV2254](#), [TLV2254A](#)
- Automotive: [TLV2252-Q1](#), [TLV2252A-Q1](#), [TLV2254-Q1](#), [TLV2254A-Q1](#)
- Military: [TLV2252M](#), [TLV2252AM](#), [TLV2254M](#), [TLV2254AM](#)

NOTE: Qualified Version Definitions:

- Catalog - TI's standard catalog product
- Automotive - Q100 devices qualified for high-reliability automotive applications targeting zero defects
- Military - QML certified for Military and Defense Applications



## TAPE AND REEL INFORMATION



### QUADRANT ASSIGNMENTS FOR PIN 1 ORIENTATION IN TAPE



\*All dimensions are nominal

| Device        | Package Type | Package Drawing | Pins | SPQ  | Reel Diameter (mm) | Reel Width W1 (mm) | A0 (mm) | B0 (mm) | K0 (mm) | P1 (mm) | W (mm) | Pin1 Quadrant |
|---------------|--------------|-----------------|------|------|--------------------|--------------------|---------|---------|---------|---------|--------|---------------|
| TLV2252AQDREP | SOIC         | D               | 8    | 2500 | 330.0              | 12.4               | 6.4     | 5.2     | 2.1     | 8.0     | 12.0   | Q1            |
| TLV2254AQDREP | SOIC         | D               | 14   | 2500 | 330.0              | 16.4               | 6.5     | 9.0     | 2.1     | 8.0     | 16.0   | Q1            |

**TAPE AND REEL BOX DIMENSIONS**

\*All dimensions are nominal

| Device        | Package Type | Package Drawing | Pins | SPQ  | Length (mm) | Width (mm) | Height (mm) |
|---------------|--------------|-----------------|------|------|-------------|------------|-------------|
| TLV2252AQDREP | SOIC         | D               | 8    | 2500 | 367.0       | 367.0      | 35.0        |
| TLV2254AQDREP | SOIC         | D               | 14   | 2500 | 333.2       | 345.9      | 28.6        |

D (R-PDSO-G14)

PLASTIC SMALL OUTLINE



- NOTES:
- A. All linear dimensions are in inches (millimeters).
  - B. This drawing is subject to change without notice.
  - Body length does not include mold flash, protrusions, or gate burrs. Mold flash, protrusions, or gate burrs shall not exceed 0.006 (0,15) each side.
  - Body width does not include interlead flash. Interlead flash shall not exceed 0.017 (0,43) each side.
  - E. Reference JEDEC MS-012 variation AB.

D (R-PDSO-G14)

PLASTIC SMALL OUTLINE



4211283-3/E 08/12

- NOTES:
- All linear dimensions are in millimeters.
  - This drawing is subject to change without notice.
  - Publication IPC-7351 is recommended for alternate designs.
  - Laser cutting apertures with trapezoidal walls and also rounding corners will offer better paste release. Customers should contact their board assembly site for stencil design recommendations. Refer to IPC-7525 for other stencil recommendations.
  - Customers should contact their board fabrication site for solder mask tolerances between and around signal pads.

D (R-PDSO-G8)

PLASTIC SMALL OUTLINE



4040047-3/M 06/11

- NOTES:
- A. All linear dimensions are in inches (millimeters).
  - B. This drawing is subject to change without notice.
  - Body length does not include mold flash, protrusions, or gate burrs. Mold flash, protrusions, or gate burrs shall not exceed 0.006 (0,15) each side.
  - Body width does not include interlead flash. Interlead flash shall not exceed 0.017 (0,43) each side.
  - E. Reference JEDEC MS-012 variation AA.

D (R-PDSO-G8)

PLASTIC SMALL OUTLINE



- NOTES:
- A. All linear dimensions are in millimeters.
  - B. This drawing is subject to change without notice.
  - C. Publication IPC-7351 is recommended for alternate designs.
  - D. Laser cutting apertures with trapezoidal walls and also rounding corners will offer better paste release. Customers should contact their board assembly site for stencil design recommendations. Refer to IPC-7525 for other stencil recommendations.
  - E. Customers should contact their board fabrication site for solder mask tolerances between and around signal pads.

## IMPORTANT NOTICE

Texas Instruments Incorporated and its subsidiaries (TI) reserve the right to make corrections, enhancements, improvements and other changes to its semiconductor products and services per JESD46, latest issue, and to discontinue any product or service per JESD48, latest issue. Buyers should obtain the latest relevant information before placing orders and should verify that such information is current and complete. All semiconductor products (also referred to herein as "components") are sold subject to TI's terms and conditions of sale supplied at the time of order acknowledgment.

TI warrants performance of its components to the specifications applicable at the time of sale, in accordance with the warranty in TI's terms and conditions of sale of semiconductor products. Testing and other quality control techniques are used to the extent TI deems necessary to support this warranty. Except where mandated by applicable law, testing of all parameters of each component is not necessarily performed.

TI assumes no liability for applications assistance or the design of Buyers' products. Buyers are responsible for their products and applications using TI components. To minimize the risks associated with Buyers' products and applications, Buyers should provide adequate design and operating safeguards.

TI does not warrant or represent that any license, either express or implied, is granted under any patent right, copyright, mask work right, or other intellectual property right relating to any combination, machine, or process in which TI components or services are used. Information published by TI regarding third-party products or services does not constitute a license to use such products or services or a warranty or endorsement thereof. Use of such information may require a license from a third party under the patents or other intellectual property of the third party, or a license from TI under the patents or other intellectual property of TI.

Reproduction of significant portions of TI information in TI data books or data sheets is permissible only if reproduction is without alteration and is accompanied by all associated warranties, conditions, limitations, and notices. TI is not responsible or liable for such altered documentation. Information of third parties may be subject to additional restrictions.

Resale of TI components or services with statements different from or beyond the parameters stated by TI for that component or service voids all express and any implied warranties for the associated TI component or service and is an unfair and deceptive business practice. TI is not responsible or liable for any such statements.

Buyer acknowledges and agrees that it is solely responsible for compliance with all legal, regulatory and safety-related requirements concerning its products, and any use of TI components in its applications, notwithstanding any applications-related information or support that may be provided by TI. Buyer represents and agrees that it has all the necessary expertise to create and implement safeguards which anticipate dangerous consequences of failures, monitor failures and their consequences, lessen the likelihood of failures that might cause harm and take appropriate remedial actions. Buyer will fully indemnify TI and its representatives against any damages arising out of the use of any TI components in safety-critical applications.

In some cases, TI components may be promoted specifically to facilitate safety-related applications. With such components, TI's goal is to help enable customers to design and create their own end-product solutions that meet applicable functional safety standards and requirements. Nonetheless, such components are subject to these terms.

No TI components are authorized for use in FDA Class III (or similar life-critical medical equipment) unless authorized officers of the parties have executed a special agreement specifically governing such use.

Only those TI components which TI has specifically designated as military grade or "enhanced plastic" are designed and intended for use in military/aerospace applications or environments. Buyer acknowledges and agrees that any military or aerospace use of TI components which have **not** been so designated is solely at the Buyer's risk, and that Buyer is solely responsible for compliance with all legal and regulatory requirements in connection with such use.

TI has specifically designated certain components as meeting ISO/TS16949 requirements, mainly for automotive use. In any case of use of non-designated products, TI will not be responsible for any failure to meet ISO/TS16949.

### Products

|                              |  |
|------------------------------|--|
| Audio                        | <a href="http://www.ti.com/audio">www.ti.com/audio</a>                               |
| Amplifiers                   | <a href="http://amplifier.ti.com">amplifier.ti.com</a>                               |
| Data Converters              | <a href="http://dataconverter.ti.com">dataconverter.ti.com</a>                       |
| DLP® Products                | <a href="http://www.dlp.com">www.dlp.com</a>   |
| DSP                          | <a href="http://dsp.ti.com">dsp.ti.com</a>   |
| Clocks and Timers            | <a href="http://www.ti.com/clocks">www.ti.com/clocks</a>                             |
| Interface                    | <a href="http://interface.ti.com">interface.ti.com</a>                               |
| Logic                        | <a href="http://logic.ti.com">logic.ti.com</a>                                       |
| Power Mgmt                   | <a href="http://power.ti.com">power.ti.com</a>                                       |
| Microcontrollers             | <a href="http://microcontroller.ti.com">microcontroller.ti.com</a>                   |
| RFID                         | <a href="http://www.ti-rfid.com">www.ti-rfid.com</a>                                 |
| OMAP Applications Processors | <a href="http://www.ti.com/omap">www.ti.com/omap</a>                                 |
| Wireless Connectivity        | <a href="http://www.ti.com/wirelessconnectivity">www.ti.com/wirelessconnectivity</a> |

### Applications

|                               |  |
|-------------------------------|--|
| Automotive and Transportation | <a href="http://www.ti.com/automotive">www.ti.com/automotive</a>                         |
| Communications and Telecom    | <a href="http://www.ti.com/communications">www.ti.com/communications</a>                 |
| Computers and Peripherals     | <a href="http://www.ti.com/computers">www.ti.com/computers</a>                           |
| Consumer Electronics          | <a href="http://www.ti.com/consumer-apps">www.ti.com/consumer-apps</a>                   |
| Energy and Lighting           | <a href="http://www.ti.com/energy">www.ti.com/energy</a>                                 |
| Industrial                    | <a href="http://www.ti.com/industrial">www.ti.com/industrial</a>                         |
| Medical                       | <a href="http://www.ti.com/medical">www.ti.com/medical</a>                               |
| Security                      | <a href="http://www.ti.com/security">www.ti.com/security</a>                             |
| Space, Avionics and Defense   | <a href="http://www.ti.com/space-avionics-defense">www.ti.com/space-avionics-defense</a> |
| Video and Imaging             | <a href="http://www.ti.com/video">www.ti.com/video</a>                                   |

### TI E2E Community

[e2e.ti.com](http://e2e.ti.com)