



PART NUMBER	DESCRIPTION
CCP-37S	Commercial Latching TRANSFER, DC-3GHz, Low PIM
<p>These switches are designed to have extremely low passive intermodulation for use in narrow bandwidth communications applications. The CCP-37S is a long-life high performance transfer switch designed for use in 50 Ohms coaxial transmission lines operating over frequencies ranging from DC to 3 GHz. The switch is designed for minimum or where the contact paths are closed for long durations.</p> <p>This switch is provided with a magnetic latching actuator which is particularly desirable in applications where actuator power consumption must be kept to an absolute minimum. The latching type actuator requires less switching current than the failsafe type.</p>	



ENVIRONMENTAL AND PHYSICAL CHARACTERISTICS	
Operating Temperature	-40°C to 65°C
Vibration (MIL-STD-202 Method 214, Condition D, non-operating)	10 g's RMS
Shock (MIL-STD-202 Method 213, Condition D, non-operating)	500 g's
Standard Actuator Life	1,000,000 cycles
Connector Type	SMA
Humidity (Moisture Seal)	Available
Weight	9 oz. (255.2g) (max.)

ELECTRICAL CHARACTERISTICS	
Form Factor	Transfer, break before make
Frequency Range	DC–3 GHz
Characteristic Impedance	50 Ohms
Switching Time	15 ms (max.)
Actuation Voltage Available	12 15 24 28 V
Actuation Current, max. @ ambient	160 130 75 65 mA

PERFORMANCE CHARACTERISTICS	
Frequency	DC–3 GHz
Insertion Loss, dB, max.	0.2
Isolation, dB, min.	70
VSWR, max.	1.2:1
RF Power (cw), W, max	75 @ 3GHz

PASSIVE INTERMODULATION CHARACTERISTICS			
Tone 1 Frequency (MHz)	Tone 2 Frequency (MHz)	IM3 Frequency (MHz)	PIM Threshold (dBc)
1945	1990	1900	-140.0
P1 P2 (dBm)	PIM (dBc)	PEAK PIM (dBc)	
43	-152.3	-146.7	

**PART NUMBERING SYSTEM**

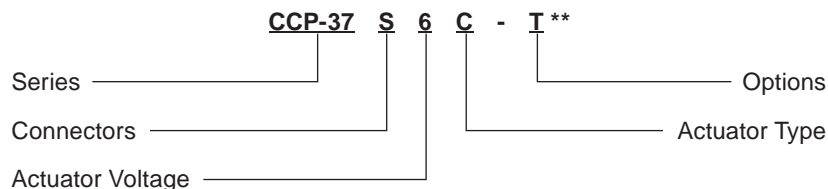

**Connector**  
S: SMA Female

**Actuator Voltage**  
6: 28 Vdc Latching  
7: 15 Vdc Latching  
8: 12 Vdc Latching  
9: 24 Vdc Latching

**Actuator Type**  
0: Standard Contacts  
C: Indicator Contacts  
D: Self Cutoff Only  
E: Indicators and Self Cutoff

**Options**  
T: TTL Drivers with Diodes  
D: Transient Suppression Diodes  
R: Positive + Common  
M: Moisture Seal  
S: 9 Pin D-Sub Connector

\*\*SEE PARTS LIST ON PAGE 6

**For additional options, contact factory.**

# Series CCP-37S

Miniature DC-3 GHz  
Low PIM Latching TRANSFER Coaxial Switch



## SCHEMATICS AND MECHANICAL OUTLINE

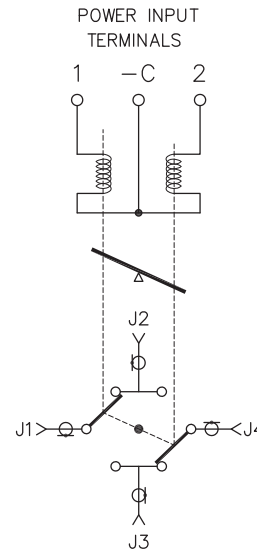
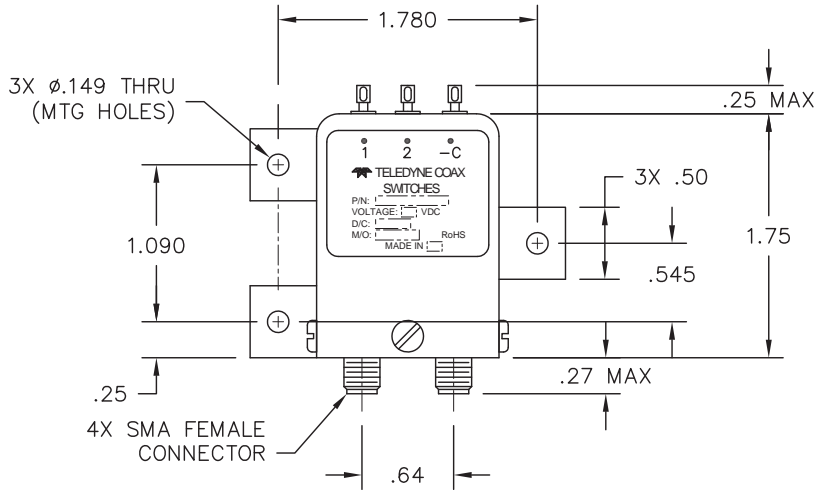

SCHMATIC

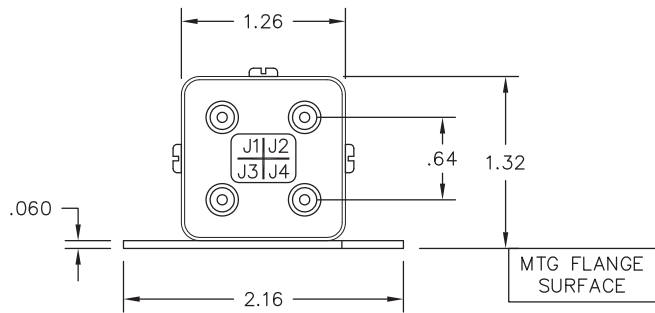

3X SOLDER WIRE TO D.C. TERMINALS MAX TEMP 250°C FOR NO MORE THAN 5 SEC

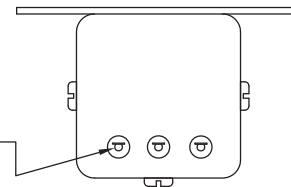

9 PIN D-SUB PINOUT FOR LATCHING TRANSFER				
OPTIONS				
Pin No.	Basic	Indicators	TTL	Indicators & TTL
1	1	1		
2	2	2		
3	C	C	Common	Common
4			1	1
5			2	2
6			Vsw	Vsw
7		A		A
8		B		B
9		C		C

TRUTH TABLE (with TTL option)							
Logic Input		RF Path				Indicator (if applicable)	
1	2	1-2	1-3	2-4	3-4	A	B
0	0	No Change				N/A	
1	0	Off	On	On	Off	A & C	
0	1	On	Off	Off	On	B & C	
1	1	Forbidden				N/A	

**TYPICAL BROADBAND RF PERFORMANCE CURVES**

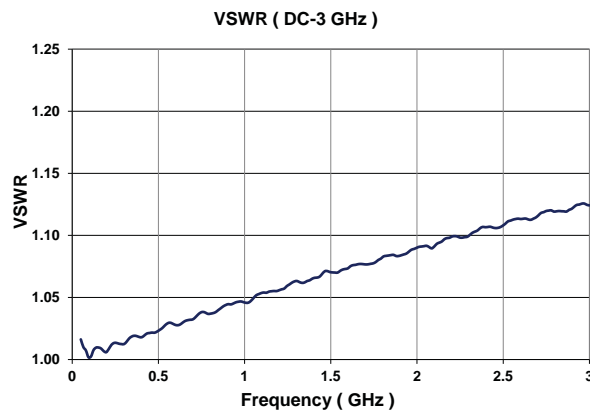
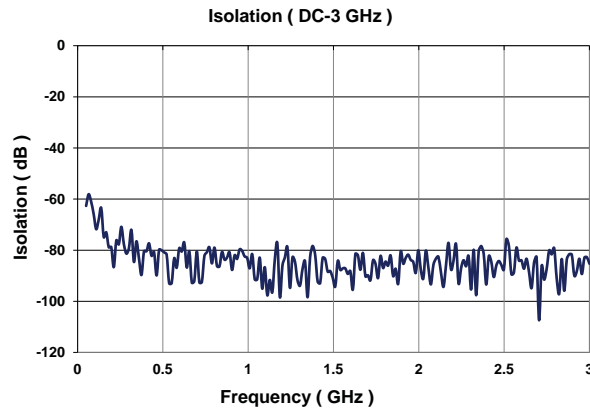
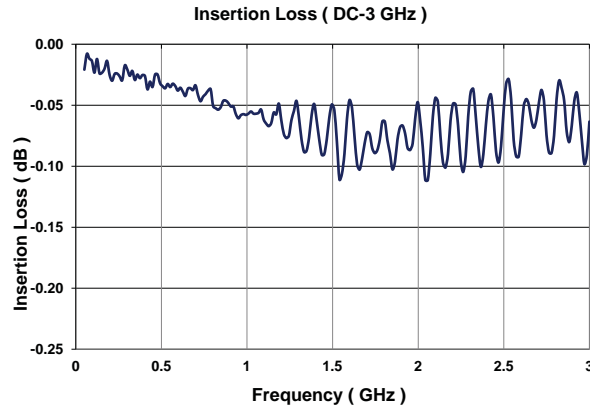

**RF NOTES**

TYPICAL POWER PERFORMANCE CURVE

# Power Handling vs. Frequency

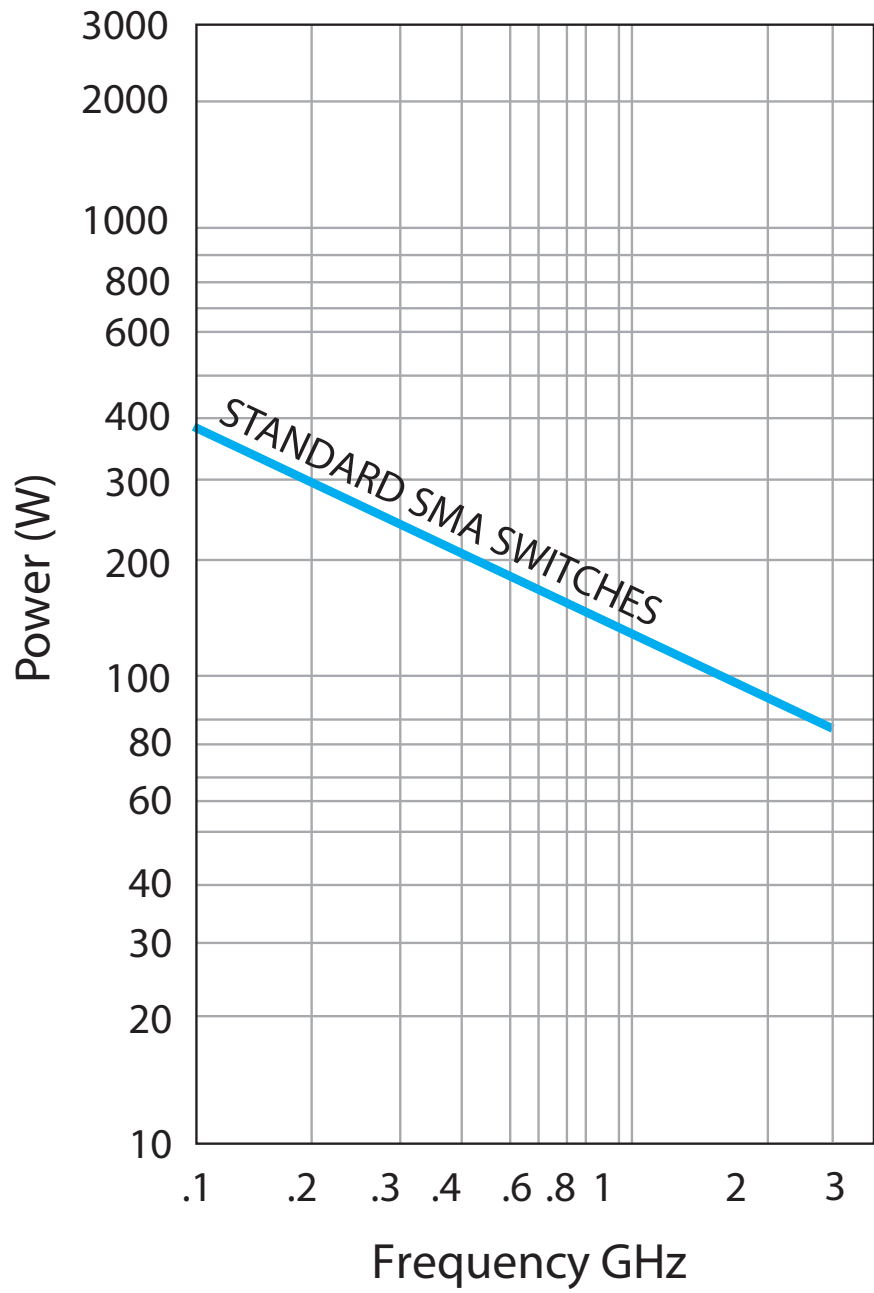

Estimates based on the following reference conditions:

- Ambient temperature of 40°C or less
- Sea level operation
- Load VSWR of 1.20:1 maximum
- No high-power (hot) switching

Please contact Teledyne Coax Switches for derating factors when applications do not meet the foregoing reference conditions.

## GLOSSARY

### Actuator

An actuator is the electromechanical mechanism that transfers the RF contacts from one position to another upon DC command.

### Arc Suppression Diode

A diode is connected in parallel with the coil. This diode limits the “reverse EMF spike” generated when the coil de-energizes to 0.7 volts. The diode cathode is connected to the positive side of the coil and the anode is connected to the negative side.

### Date Code

All switches are marked with either a unique serial number or a date code. Date codes are in accordance with MIL-STD-1285 Paragraph 5.2.5 and consist of four digits. The first two digits define the year and the last two digits define the week of the year (YYWW). Thus, 1032 identifies switches that passed through final inspection during the 32nd week of 2010.

### Latching

A latching switch remains in the selected position whether or not voltage is maintained. This can be accomplished with either a magnetic or mechanical latching mechanism.

### Indicator

Indicators tell the system which position the switch is in. Other names for indicators are telemetry contacts or tellback circuit. Indicators are usually a set of internally mounted DC contacts linked to the actuator. They can be wired to digital input lines, status lights, or interlocks. Unless otherwise specified, the maximum indicator contact rating is 30 Vdc, 50 mA, or 1.5 Watts into a resistive load.

### Isolation

Isolation is the measure of the power level at the output connector of an unconnected RF channel as referenced to the power at the input connector. It is specified in dB below the input power level.

### Self-Cutoff

The self-cutoff option disables the actuator current on completion of actuation. Either a series contact (linked to the actuator) or an IC driver circuit provides the current cutoff. This option results in minimum power consumption by the RF switch. Cutthroat is another name used in the industry for this option. Pulse latching is a term used to describe a switch without this feature.

### TRANSFER Switch

A four-port switch consisting of two independent pairs of RF paths. These pairs are actuated simultaneously. This actuation is similar to that of a double-pole double-throw switch.

### Switching Time

Switching time is the total interval beginning with the arrival of the leading edge of the command pulse at the switch DC

input and ending with the completion of the switch transfer, including contact bounce. It consists of three parts: (1) inductive delay in the coil, (2) transfer time of the physical movement of the contacts, and (3) the bounce time of the RF contacts.

### TTL Switch Driver Option

As a special option, switch drivers can be provided for both failsafe and latching switches, which are compatible with industry-standard low-power Schottky TTL circuits.

### Performance Parameters vs Frequency

Generally speaking, the RF performance of coaxial switches is frequency dependent. With increasing frequency, VSWR and insertion loss increase while isolation decreases. All data sheets specify these three parameters as “worst case” at the highest operating frequency. If the switch is to be used over a narrow frequency band, better performance can be achieved.

### Actuator Current vs Temperature

The resistance of the actuator coil varies as a function of temperature. There is an inverse relationship between the operating temperature of the switch and the actuator drive current. For switches operating at 28 VDC, the approximate actuator drive current at temperature, T, can be calculated using the equation:

$$I_T = \frac{I_A}{[1 + .00385 (T-20)]}$$

Where:

$I_T$  = Actuator current at temperature, T

$I_A$  = Room temperature actuator current – see data sheet

T = Temperature of interest in °C

### Magnetic Sensitivity

An electro-mechanical switch can be sensitive to ferrous materials and external magnetic fields. Neighboring ferrous materials should be permitted no closer than 0.5 inches and adjacent external magnetic fields should be limited to a flux density of less than 5 Gauss.

**Series CCP-37S**  
 Miniature DC–3 GHz  
 Low PIM Latching TRANSFER Coaxial Switch



**LATCHING CCP-37S PART NUMBER LIST**

	PART No.		PART No.
1	CCP-37SXC	43	CCP-37SX0
2	CCP-37SXC-D	44	CCP-37SX0-D
3	CCP-37SXC-DM	45	CCP-37SX0-DM
4	CCP-37SXC-DMS	46	CCP-37SX0-DMS
5	CCP-37SXC-DR	47	CCP-37SX0-DR
6	CCP-37SXC-DRM	48	CCP-37SX0-DRM
7	CCP-37SXC-DRMS	49	CCP-37SX0-DRMS
8	CCP-37SXC-DRS	50	CCP-37SX0-DRS
9	CCP-37SXC-DS	51	CCP-37SX0-DS
10	CCP-37SXC-M	52	CCP-37SX0-M
11	CCP-37SXC-MS	53	CCP-37SX0-MS
12	CCP-37SXC-R	54	CCP-37SX0-R
13	CCP-37SXC-RM	55	CCP-37SX0-RM
14	CCP-37SXC-RMS	56	CCP-37SX0-RMS
15	CCP-37SXC-RS	57	CCP-37SX0-RS
16	CCP-37SXC-S	58	CCP-37SX0-S
17	CCP-37SXC-T	59	CCP-37SX0-T
18	CCP-37SXC-TM	60	CCP-37SX0-TM
19	CCP-37SXC-TMS	61	CCP-37SX0-TMS
20	CCP-37SXC-TS	62	CCP-37SX0-TS
21	CCP-37SXD		
22	CCP-37SXD-M		
23	CCP-37SXD-MS		
24	CCP-37SXD-R		
25	CCP-37SXD-RM		
26	CCP-37SXD-RMS		
27	CCP-37SXD-RS		
28	CCP-37SXD-S		
29	CCP-37SXD-T		
30	CCP-37SXD-TM		
31	CCP-37SXD-TMS		
32	CCP-37SXE		
33	CCP-37SXE-M		
34	CCP-37SXE-MS		
35	CCP-37SXE-R		
36	CCP-37SXE-RM		
37	CCP-37SXE-RMS		
38	CCP-37SXE-RS		
39	CCP-37SXE-S		
40	CCP-37SXE-T		
41	CCP-37SXE-TM		
42	CCP-37SXE-TMS		

\* X = 6 (28Vdc), 7 (15Vdc), 8 (12Vdc) and 9 (24Vdc)