

Typical Applications

The HMC798LC4 is ideal for:

- Point-to-Point Radios
- Point-to-Multi-Point Radios & VSAT
- Test Equipment & Sensors
- Military End-Use
- SAT COM

Features

- Integrated LO Amplifier: +4 dBm Input
- Sub-Harmonically Pumped (x2) LO
- Wideband IF: DC - 4 GHz
- Single Positive Supply: +5V @ 95mA
- 24 Lead 4x4mm SMT Package: 16mm²

Functional Diagram

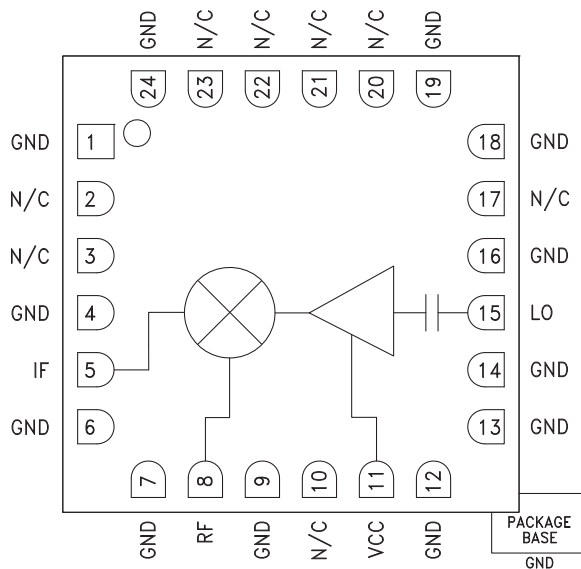

General Description

The HMC798LC4 is a 24 - 34 GHz Sub-harmonically Pumped (x2) MMIC Mixer with an integrated LO amplifier in a leadless RoHS compliant SMT package. The 2LO to RF isolation is excellent at 30 dB, eliminating the need for additional filtering. The LO amplifier is a single bias +5V design with a nominal +4 dBm drive requirement. The RF and LO ports are matched to 50 Ohms for ease of use while the IF covers DC to 4 GHz. The HMC798LC4 eliminates the need for wire bonding, allowing use of surface mount manufacturing techniques.

Electrical Specifications, $T_A = +25^\circ\text{C}$, $V_{CC} = 5V$

Parameter	IF = 1 GHz LO = 4 dBm			IF = 1 GHz LO = 4 dBm			Units
	Min.	Typ.	Max.	Min.	Typ.	Max.	
Frequency Range, RF	24 - 29.5			29.5 - 34			GHz
Frequency Range, LO	12 - 16			13.5 - 17.75			GHz
Frequency Range, IF	DC - 4			DC - 4			GHz
Conversion Loss		11	13		10	12	dB
2LO to RF Isolation	25	30		20	25		dB
2LO to IF Isolation		45			35		dB
IP3 (Input)	17	20		19	22		dBm
1 dB Compression (Input)		10			12		dBm
Supply Current (I _{dd})		95	125		95	125	mA

*Unless otherwise noted, all measurements performed as upconverter, IF= 1 GHz, LO = 4 dBm

Conversion Gain vs. Temperature, LSB

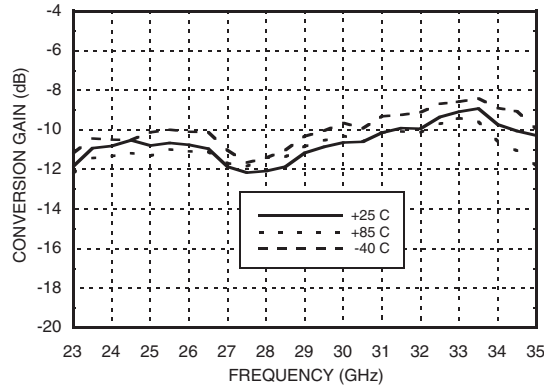

Conversion Gain vs. Temperature, USB

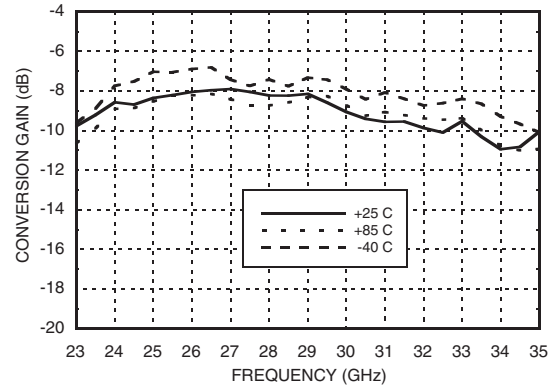

Conversion Gain vs. LO Drive, LSB

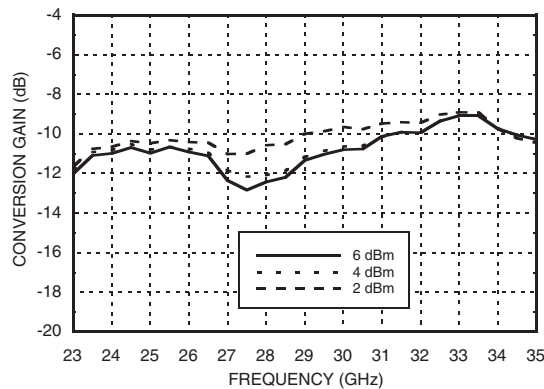

Isolations

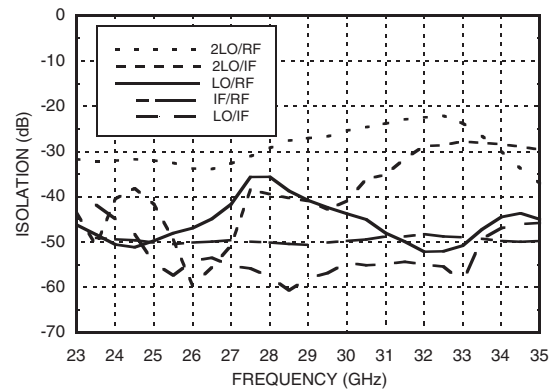

Input IP3 vs. LO Drive

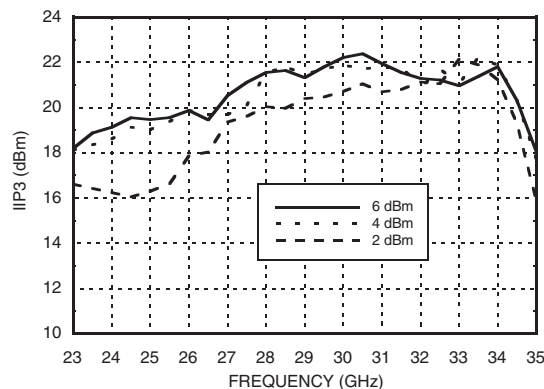

Input IP3 vs. Temperature

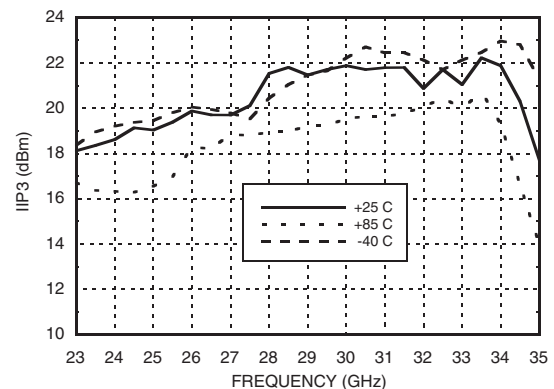



Input IP2 vs. LO Drive

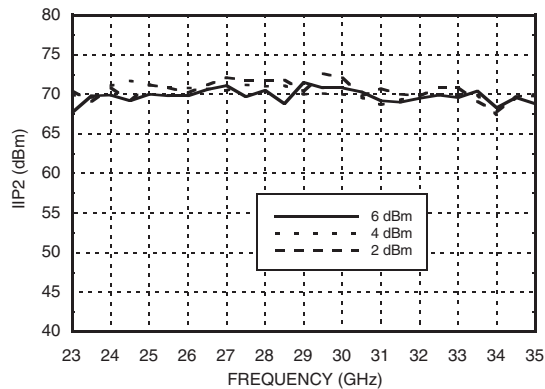

Input IP2 vs. Temperature

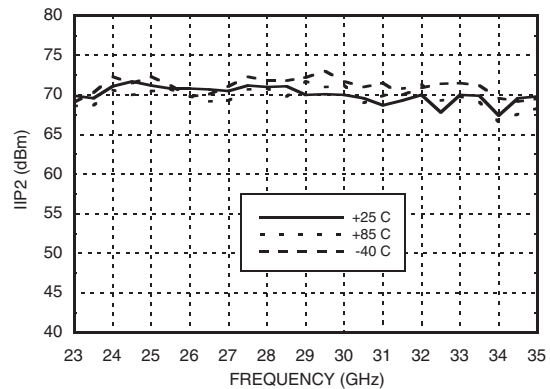

Input P1dB vs. Temperature, LSB

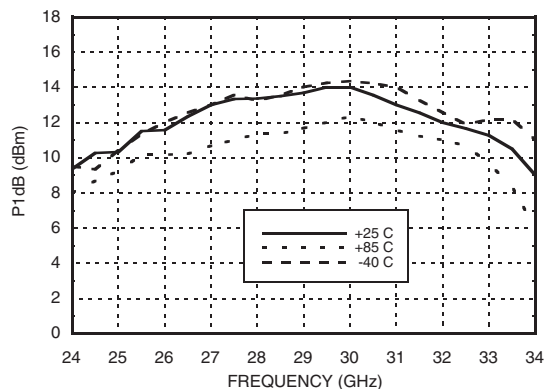

Input P1dB vs. Temperature, USB

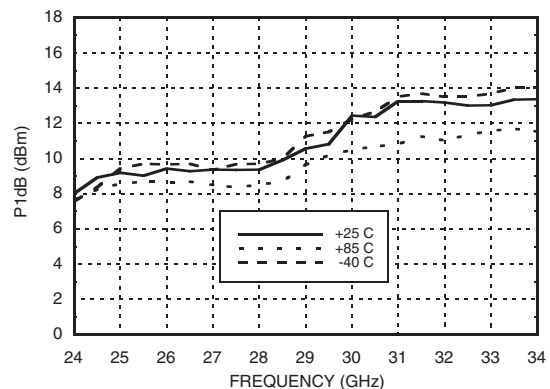

Conversion Gain vs. IF Frequency, LSB

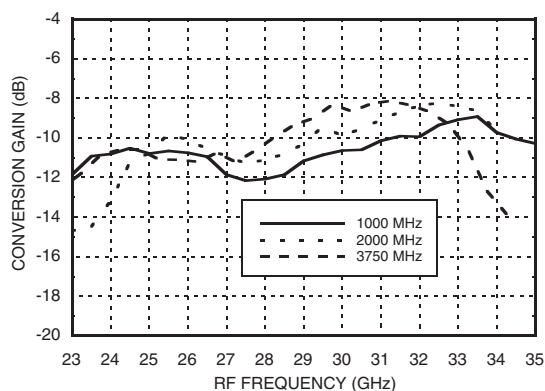

Conversion Gain vs. IF Frequency, USB

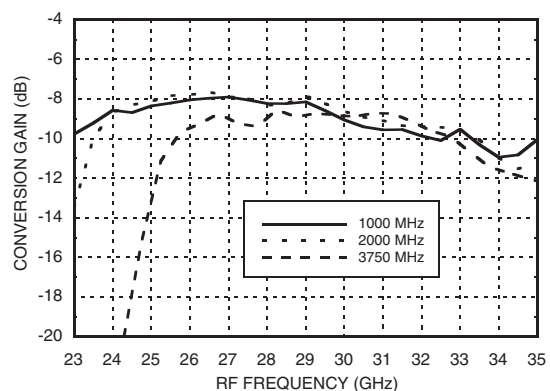

* Two-tone input power = 0 dBm each tone, 1 MHz spacing.

For price, delivery, and to place orders, please contact Hittite Microwave Corporation:
20 Alpha Road, Chelmsford, MA 01824 Phone: 978-250-3343 Fax: 978-250-3373
Order On-line at www.hittite.com

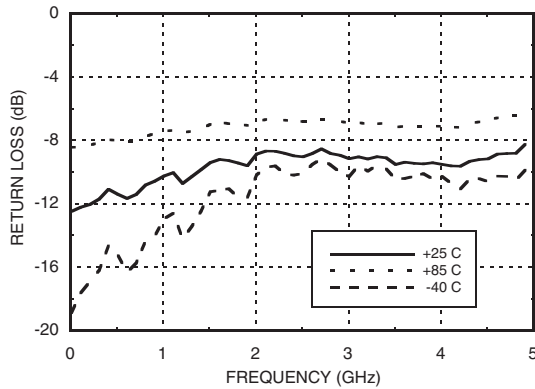
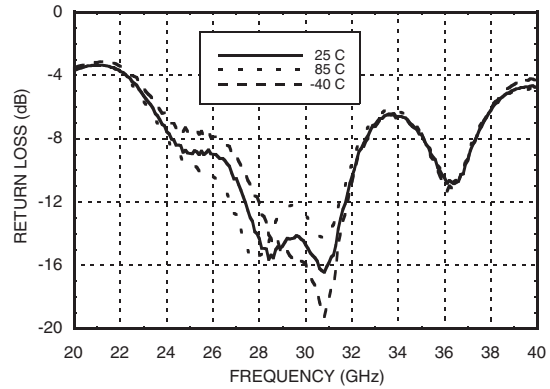
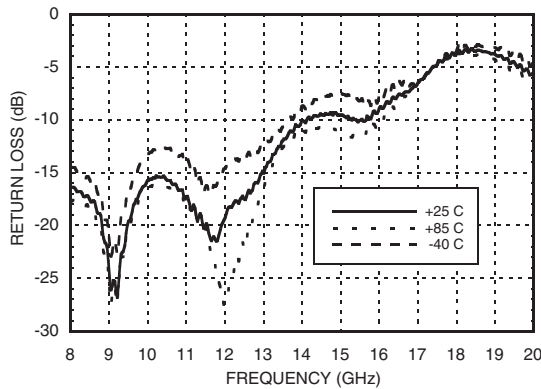
IF Return Loss

RF Return Loss

LO Return Loss

**MxN Spurious Outputs
@ RF Port, Vdd = 5V**

mIF	nLO		
	2	1	0
-3	68		
-2	53	71	66
-1	0	49	32
0	1	31	
1	1	45	31
2	54	66	65
3	66		

IF = 2 GHz @ -10 dBm
 LO = 15 GHz @ 4 dBm
 All values in dBc below IF power level (2LO - 1IF)
 Measured as upconverter

Absolute Maximum Ratings

RF / IF Input (Vdd = +5V)	+13 dBm
LO Drive (Vdd = +5V)	+10 dBm
Vdd	5.5V
Channel Temperature	175 °C
Continuous P _{diss} (T _a = 85 °C) (derate 8.33 mW/°C above 85 °C)	0.75 mW
Thermal Resistance (junction to ground paddle)	119 °C/W
Storage Temperature	-65 to +150 °C
Operating Temperature	-40 to +85 °C



ELECTROSTATIC SENSITIVE DEVICE
OBSERVE HANDLING PRECAUTIONS

10

MIXERS - SUB-HARMONIC - SMT

Outline Drawing

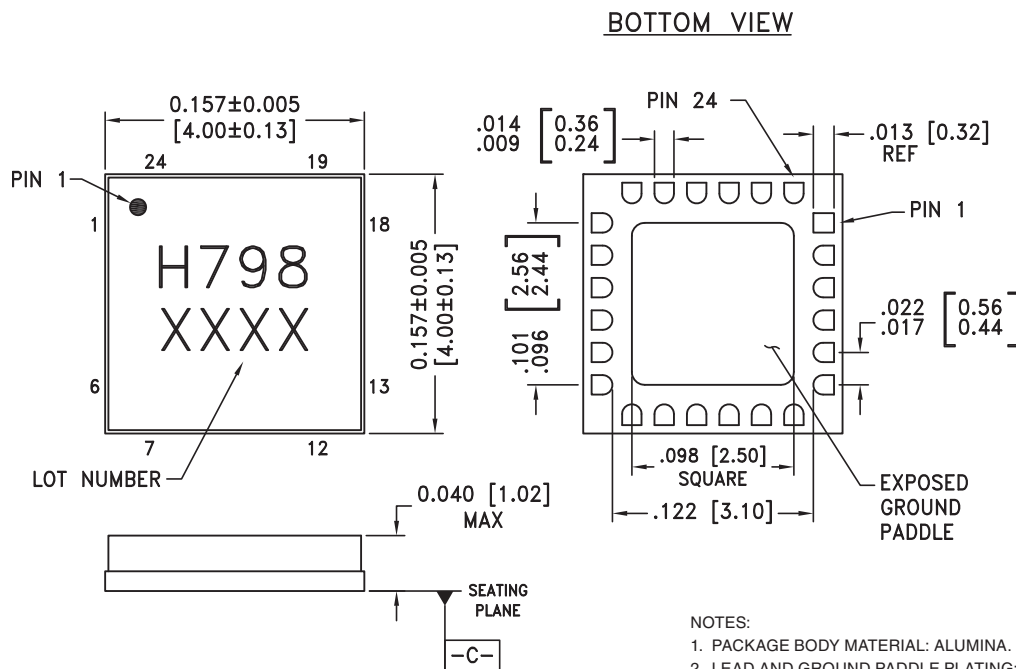

NOTES:

1. PACKAGE BODY MATERIAL: ALUMINA.
2. LEAD AND GROUND PADDLE PLATING: GOLD FLASH OVER NICKEL.
3. DIMENSIONS ARE IN INCHES (MILLIMETERS).
4. LEAD SPACING TOLERANCE IS NON-CUMULATIVE.
5. CHARACTERS TO BE HELVETICA MEDIUM, .025 HIGH, BLACK INK, OR LASER MARK LOCATED APPROX. AS SHOWN.
6. PACKAGE WARP SHALL NOT EXCEED 0.05MM DATUM -C-
7. ALL GROUND LEADS AND GROUND PADDLE MUST BE SOLDERED TO PCB RF GROUND.

Pin Descriptions

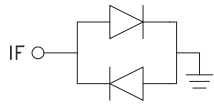
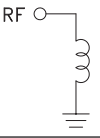
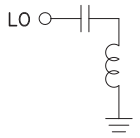
Pin Number	Function	Description	Interface Schematic
1, 4, 6, 7, 9, 12 - 14, 16, 18, 19, 24	GND	These pins and package bottom must be connected to RF/DC ground.	
2, 3, 10, 17, 20 - 23	N/C	No connection required. The pins are not connected internally; however, all data shown herein was measured with these pins connected to RF/DC ground externally.	
5	IF	This pin is DC coupled and should be DC blocked externally using a series capacitor whose value has been chosen to pass the necessary IF frequency range. Any applied DC voltage to this pin will result in die non-function and possible die failure.	
8	RF	This pin is DC coupled and matched to 50 Ohms.	
11	Vcc	Power supply for the LO Amplifier.	
15	LO	This pin is DC blocked and matched to 50 Ohms.	

Evaluation PCB

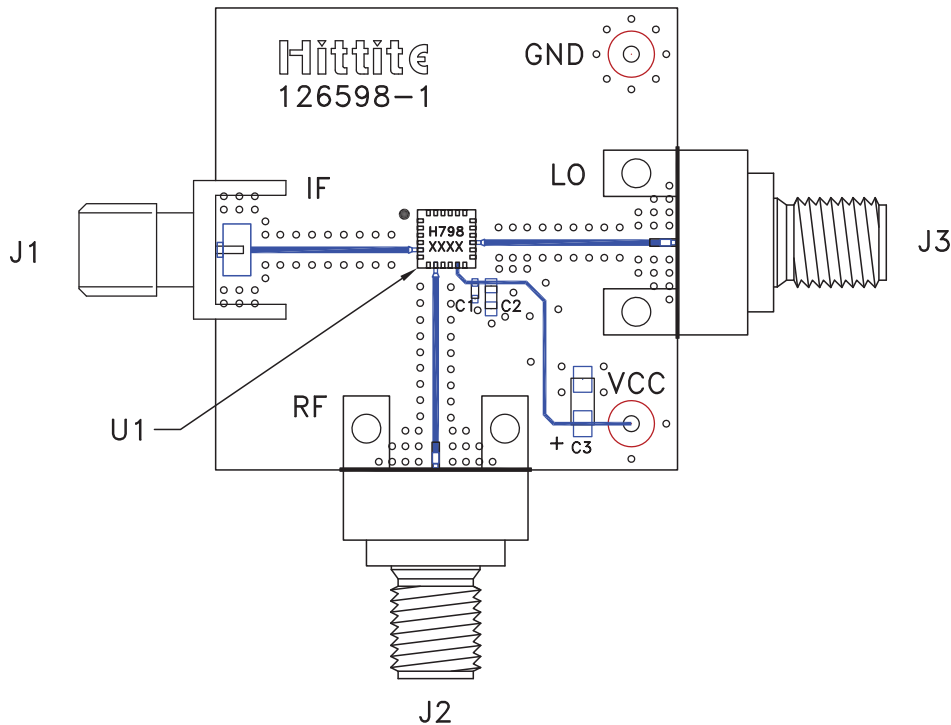

List of Materials for Evaluation PCB 126601 [1]

Item	Description
J1 - J3	PCB Mount SMA RF Connector
J2, J3	PCB Mount SRI K Connector
J4, J5	DC Pin
C1	100 pF Capacitor, 0402 Pkg.
C2	10,000 pF Capacitor, 0603 Pkg.
C3	4.7 μF Tantalum Capacitor, Case A
U1	HMC798LC4 Mixer
PCB [2]	126598 Evaluation PCB

[1] Reference this number when ordering complete evaluation PCB

[2] Circuit Board Material: Arlon 25FR or Rogers 4350

The circuit board used in this application should use RF circuit design techniques. Signal lines should have 50 Ohm impedance while the package ground leads and exposed paddle should be connected directly to the ground plane similar to that shown. A sufficient number of via holes should be used to connect the top and bottom ground planes. The evaluation board should be mounted to an appropriate heat sink. The evaluation circuit board shown is available from Hittite upon request.



Notes: