

Data sheet | Item number: 750-466/025-000

2-channel analog input; 4 ... 20 mA; Single-ended; Ext. Temperature

www.wago.com/750-466/025-000



 Picture differs from the item.

Color: 

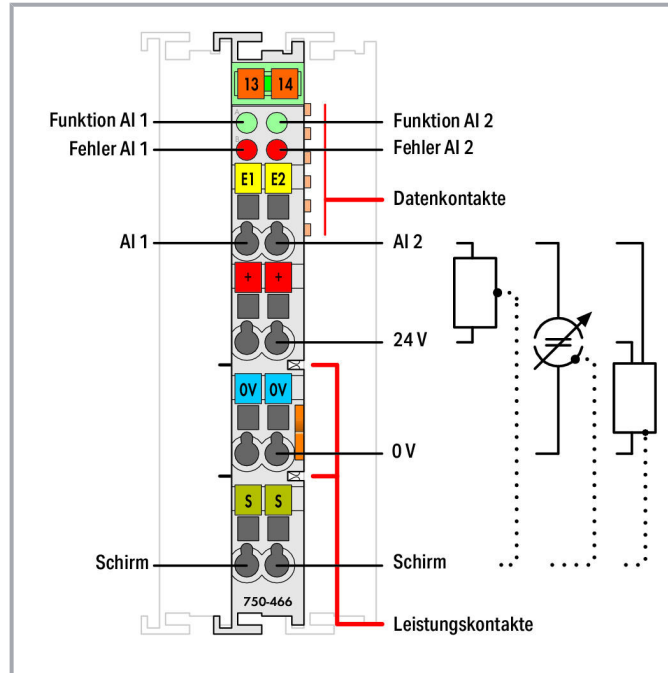

Subject to changes. Please also observe the further product documentation!

WAGO Kontakttechnik GmbH & Co. KG
Hansastr. 27
32423 Minden
Phone: +49571 887-0 | Fax: +49571 887-169
Email: info.de@wago.com | Web: www.wago.com

Do you have any questions about our products?
We are always happy to take your call at +49 (571) 887-44222.

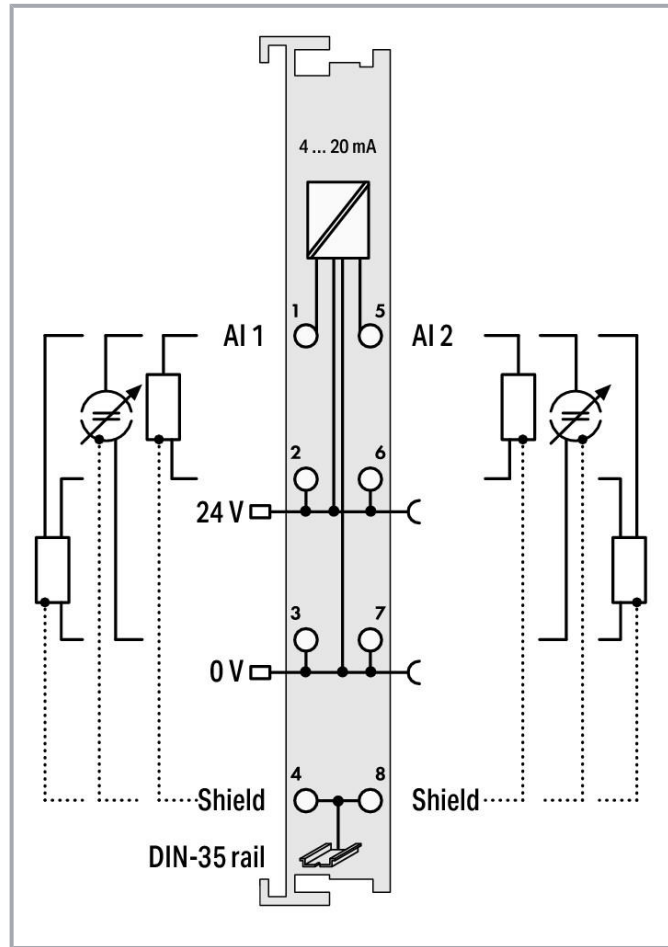
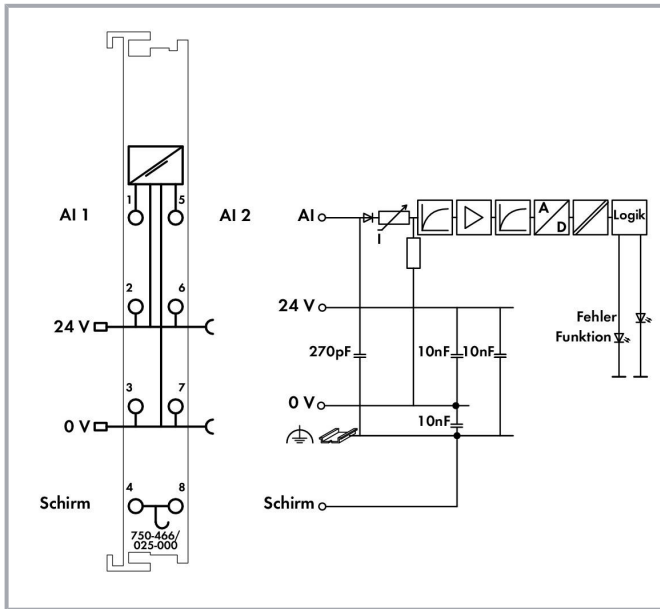

Item description

This analog input module powers field-side signal conditioners and transmits electrically isolated analog signals to the bus system.

The 24 V field supply is derived from the module's power jumper contacts.

The shield directly connects to the DIN-rail.

This module supplies the voltage for 2-wire signal conditioners that have no power supply of their own.

Data

Technical data

Number of analog inputs	2
Total number of channels (module)	2
Signal type	Current

Subject to changes. Please also observe the further product documentation!



Signal type (current)	4 ... 20 mADC
Sensor connection	2 x (2-wire, 3-wire)
Input voltage (max.)	10 V
Signal characteristic	Single-ended
Resolution [bit]	12 bits
Input resistance (max.)	220 Ω
Data width	2 x 16-bit data; 2 x 8-bit control/status (optional)
Conversion time (typ.)	2 ms
Measurement error (reference temperature)	25 °C
Measurement error – deviation (max.) from the upper-range value	0.2 %
Temperature error (max.) of the upper-range value	0.01 %/K
Supply voltage (system)	5 VDC; via data contacts
Power consumption (5 V system supply)	75 mA
Supply voltage (field)	24 VDC (-25 ... +30 %); via power jumper contacts (power supply via blade contact; transmission via spring contact)
Isolation	500 V system/field
Number of incoming power jumper contacts	2
Number of outgoing power jumper contacts	2

Connection data

Connection technology: inputs/outputs	8 x CAGE CLAMP®
Connection type (1)	Inputs/Outputs
Solid conductor	0.08 ... 2.5 mm ² / 28 ... 14 AWG
Fine-stranded conductor	0.08 ... 2.5 mm ² / 28 ... 14 AWG
Strip length	8 ... 9 mm / 0.31 ... 0.35 inch

Physical data

Width	12 mm / 0.472 inch
Height	100 mm / 3.937 inch
Depth	69.8 mm / 2.748 inch
Depth from upper edge of DIN-rail	62.6 mm / 2.465 inch

Mechanical data

Mounting type	DIN-35 rail
---------------	-------------

Subject to changes. Please also observe the further product documentation!



Material data

Color	light gray
Housing material	Polycarbonate; polyamide 6.6
Fire load	0.918 MJ
Weight	51.5 g
Conformity marking	CE

Environmental requirements

Surrounding air temperature (operation)	-20 ... 60 °C
Surrounding air temperature (storage)	-40 ... 85 °C
Protection type	IP20
Pollution degree (5)	2 per IEC 61131-2
Operating altitude	0 ... 2000 m
Mounting position	horizontal (standing/lying); vertical
Relative humidity (without condensation)	95 %
Relative humidity (with condensation)	Short-term condensation per Class 3K6/IEC EN 60721-3-3 and E-DIN 40046-721-3, accounting for a temperature range of -20 to +60 °C (except for wind-driven precipitation, water and ice formation)
Vibration resistance	per IEC 60068-2-6
Shock resistance	15g per IEC 60068-2-27
EMC immunity to interference	per EN 61000-6-2
EMC emission of interference	per EN 61000-6-4
Exposure to pollutants	Per IEC 60068-2-42 and IEC 60068-2-43
Permissible H ₂ S contaminant concentration at a relative humidity 75 %	10 ppm
Permissible SO ₂ contaminant concentration at a relative humidity 75 %	25 ppm

Commercial data

Product Group	15 (Remote I/O)
PU (SPU)	1 Stück
Packaging type	box
Country of origin	DE
GTIN	4050821287223
Customs tariff number	85389099990





Subject to changes. Please also observe the further product documentation!

WAGO Kontakttechnik GmbH & Co. KG
 Hansastr. 27
 32423 Minden
 Phone: +49571 887-0 | Fax: +49571 887-169
 Email: info.de@wago.com | Web: www.wago.com

Do you have any questions about our products?
 We are always happy to take your call at +49 (571) 887-44222.

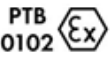
Approvals / Certificates

Ex-Approvals

Logo	Approval	Additional Approval Text	Certificate name
	ATEX TUEV Nord Cert GmbH	EN 60079-0	TÜV 07 ATEX 554086 X en.
 Ex nA IIC T4 Gc	CCCEx CQST/CNEx	CNCA-C23-01	2020312310000215
	EAC Brjansker Zertifizierungsstelle	TP TC 012/2011	EAC RU C-DE.AM02. B.00163/19
	TUEV Nord TUEV Nord Cert GmbH	IEC 60079-0	IECEX TUN 09.0001 X
	UL Underwriters Laboratories Inc. (HAZARDOUS LOCATIONS)	UL 121201	E198726 Sec.1

Country specific Approvals

Logo	Approval	Additional Approval Text	Certificate name
	KC National Radio Research Agency	Article 58-2, Clause 3	MSIP- REM-W43- AIM750

UL-Approvals

Logo	Approval	Additional Approval Text	Certificate name
	UL UL International Netherlands B.V. (ORDINARY LOCATIONS)	UL 508	E175199 Sec.1

Optional accessories

Carrier rail

Item no.: 210-112

Subject to changes. Please also observe the further product documentation!

 Steel carrier rail; 35 x 7.5 mm; 1 mm thick; 2 m long; slotted; according to EN 60715; "Hole width 25 mm; www.wago.com/210-112
silver-colored

 **Item no.: 210-113**
Steel carrier rail; 35 x 7.5 mm; 1 mm thick; 2 m long; unslotted; according to EN 60715; silver-colored www.wago.com/210-113

 **Item no.: 210-114**
Steel carrier rail; 35 x 15 mm; 1.5 mm thick; 2 m long; unslotted; similar to EN 60715; silver-colored www.wago.com/210-114

 **Item no.: 210-115**
Steel carrier rail; 35 x 7.5 mm; 1 mm thick; 2 m long; slotted; according to EN 60715; "Hole width 18 mm; www.wago.com/210-115
silver-colored

 **Item no.: 210-118**
Steel carrier rail; 35 x 15 mm; 2.3 mm thick; 2 m long; unslotted; according to EN 60715; silver-colored www.wago.com/210-118

 **Item no.: 210-196**
Aluminum carrier rail; 35 x 8.2 mm; 1.6 mm thick; 2 m long; unslotted; similar to EN 60715; silver-colored www.wago.com/210-196

 **Item no.: 210-197**
Steel carrier rail; 35 x 15 mm; 1.5 mm thick; 2 m long; slotted; similar to EN 60715; silver-colored www.wago.com/210-197

 **Item no.: 210-198**
Copper carrier rail; 35 x 15 mm; 2.3 mm thick; 2 m long; unslotted; according to EN 60715; copper-colored www.wago.com/210-198

 **Item no.: 210-504**
Steel carrier rail; 35 x 7.5 mm; 1 mm thick; 2 m long; slotted; galvanized; according to EN 60715; silver-colored www.wago.com/210-504

 **Item no.: 210-505**
Steel carrier rail; 35 x 7.5 mm; 1 mm thick; 2 m long; unslotted; galvanized; according to EN 60715; silver-colored www.wago.com/210-505

 **Item no.: 210-506**
Steel carrier rail; 35 x 15 mm; 1.5 mm thick; 2 m long; unslotted; galvanized; similar to EN 60715; silver-colored www.wago.com/210-506

 **Item no.: 210-508**
Steel carrier rail; 35 x 15 mm; 1.5 mm thick; 2 m long; slotted; galvanized; similar to EN 60715; silver-colored www.wago.com/210-508

Shield termination

 **Item no.: 790-108**
Shield clamping saddle; 11 mm wide; diameter of compatible conductor; 3 ... 8 mm www.wago.com/790-108





 **Item no.: 790-116**
Shield clamping saddle; 19 mm wide; diameter of compatible conductor; 7 ... 16 mm www.wago.com/790-116

 **Item no.: 790-124**
Shield clamping saddle; 27 mm wide; diameter of compatible conductor; 6 ... 24 mm www.wago.com/790-124

 **Item no.: 790-140**
Shield clamping saddle; diameter of compatible conductor www.wago.com/790-140

 **Item no.: 790-208**
Shield clamping saddle; 12.4 mm wide; 3 ... 8 mm www.wago.com/790-208

Subject to changes. Please also observe the further product documentation!

	Item no.: 790-216 Shield clamping saddle; 21.8 mm wide; 6 ... 16 mm	www.wago.com/790-216
	Item no.: 790-220 Shield clamping saddle; 30 mm wide; 6 ... 20 mm	www.wago.com/790-220
Supply module		
	Item no.: 750-602/025-000 Power Supply; 24 VDC; Ext. Temperature	www.wago.com/750-602/025-000
Marking accessories		
	Item no.: 2009-145 Mini-WSB Inline; for Smart Printer; 1700 pieces on roll; stretchable 5 - 5.2 mm; plain; snap-on type; white	www.wago.com/2009-145
	Item no.: 2009-145/000-002 Mini-WSB Inline; for Smart Printer; 1700 pieces on roll; stretchable 5 - 5.2 mm; plain; snap-on type; yellow	www.wago.com/2009-145/000-002
	Item no.: 2009-145/000-005 Mini-WSB Inline; for Smart Printer; 1700 pieces on roll; stretchable 5 - 5.2 mm; plain; snap-on type; red	www.wago.com/2009-145/000-005
	Item no.: 2009-145/000-006 Mini-WSB Inline; for Smart Printer; 1700 pieces on roll; stretchable 5 - 5.2 mm; plain; snap-on type; blue	www.wago.com/2009-145/000-006
	Item no.: 2009-145/000-007 Mini-WSB Inline; for Smart Printer; 1700 pieces on roll; stretchable 5 - 5.2 mm; plain; snap-on type; gray	www.wago.com/2009-145/000-007
	Item no.: 2009-145/000-012 Mini-WSB Inline; for Smart Printer; 1700 pieces on roll; stretchable 5 - 5.2 mm; plain; snap-on type; orange	www.wago.com/2009-145/000-012
	Item no.: 2009-145/000-023 Mini-WSB Inline; for Smart Printer; 1700 pieces on roll; stretchable 5 - 5.2 mm; plain; snap-on type; green	www.wago.com/2009-145/000-023
	Item no.: 2009-145/000-024 Mini-WSB Inline; for Smart Printer; 1700 pieces on roll; stretchable 5 - 5.2 mm; plain; snap-on type; violet	www.wago.com/2009-145/000-024
	Item no.: 248-501 Mini-WSB marking card; as card; not stretchable; plain; snap-on type; white	www.wago.com/248-501
	Item no.: 248-501/000-002 Mini-WSB marking card; as card; not stretchable; plain; snap-on type; yellow	www.wago.com/248-501/000-002
	Item no.: 248-501/000-005 Mini-WSB marking card; as card; not stretchable; plain; snap-on type; red	www.wago.com/248-501/000-005

Subject to changes. Please also observe the further product documentation!

 **Item no.: 248-501/000-006**
Mini-WSB marking card; as card; not stretchable; plain; snap-on type; blue www.wago.com/248-501/000-006

 **Item no.: 248-501/000-007**
Mini-WSB marking card; as card; not stretchable; plain; snap-on type; gray www.wago.com/248-501/000-007

 **Item no.: 248-501/000-012**
Mini-WSB marking card; as card; not stretchable; plain; snap-on type; orange www.wago.com/248-501/000-012

 **Item no.: 248-501/000-017**
Mini-WSB marking card; as card; not stretchable; plain; snap-on type; light green www.wago.com/248-501/000-017

 **Item no.: 248-501/000-023**
Mini-WSB marking card; as card; not stretchable; plain; snap-on type; green www.wago.com/248-501/000-023

 **Item no.: 248-501/000-024**
Mini-WSB marking card; as card; not stretchable; plain; snap-on type; violet www.wago.com/248-501/000-024

 **Item no.: 750-100**
Marker card; as a DIN A4 sheet; plain www.wago.com/750-100

Item no.: 750-103
Group marker carrier www.wago.com/750-103

 **Item no.: 750-106**
Group marker carrier www.wago.com/750-106

System housing

 **Item no.: 850-814/002-000**
IP65 enclosure; Sheet steel (RAL 7035); WxHxD (200x120x200 mm); without flange plate www.wago.com/850-814/002-000

 **Item no.: 850-815/002-000**
IP65 enclosure; Sheet steel (RAL 7035); WxHxD (300x120x200 mm); without flange plate www.wago.com/850-815/002-000

 **Item no.: 850-816/002-000**
IP65 enclosure; Sheet steel (RAL 7035); WxHxD (400x120x200 mm); without flange plate www.wago.com/850-816/002-000

 **Item no.: 850-817/002-000**
IP65 enclosure; Sheet steel (RAL 7035); WxHxD (600x120x200 mm); without flange plate www.wago.com/850-817/002-000

 **Item no.: 850-825**
IP65 enclosure; Aluminium (RAL 7032); WxHxD (160x100x160 mm); 9 x M12, 4 x M20 www.wago.com/850-825

Subject to changes. Please also observe the further product documentation!



	Item no.: 850-826 IP65 enclosure; Aluminium (RAL 7032); WxHxD (240x100x160 mm); 4 x M20, 4 x M16, 14 x M12 cable grip	www.wago.com/850-826
	Item no.: 850-826/002-000 IP65 enclosure; Aluminium (RAL 7035); WxHxD (240x100x160 mm); 4 x M20, 4 x M16, 14 x M12 cable grip	www.wago.com/850-826/002-000
	Item no.: 850-827 IP65 enclosure; Aluminium (RAL 7032); WxHxD (320x100x160 mm); 4 x M20, 8 x M16, 17 x M12 cable grip	www.wago.com/850-827
	Item no.: 850-827/002-000 IP65 enclosure; Aluminium (RAL 7035); WxHxD (320x100x160 mm); 4 x M20, 8 x M16, 17 x M12 cable grip	www.wago.com/850-827/002-000
	Item no.: 850-828 IP65 enclosure; Aluminium (RAL 7032); WxHxD (480x100x160 mm); 4 x M20, 10 x M16, 35 x M12 cable grip	www.wago.com/850-828
	Item no.: 850-828/002-000 IP65 enclosure; Aluminium (RAL 7035); WxHxD (480x100x160 mm); 4 x M20, 10 x M16, 35 x M12 cable grip	www.wago.com/850-828/002-000
	Item no.: 850-834 IP65 enclosure; Polyester (RAL 7032); WxHxD (164x100x164 mm); 9 x M12, 4 x M20	www.wago.com/850-834
	Item no.: 850-835 IP65 enclosure; Polyester (RAL 7032); WxHxD (244x100x164 mm); 4 x M20, 4 x M16, 14 x M12 cable grip	www.wago.com/850-835
	Item no.: 850-836 IP65 enclosure; Polyester (RAL 7032); WxHxD (324x100x164 mm); 4 x M20, 8 x M16, 17 x M12 cable grip	www.wago.com/850-836

Downloads

Documentation

Manual

4-20mA, single-ended	V 1.4.0	pdf 2.0 MB	Download
System Manual WAGO I/O System 750 / 753 Decentralized Automation Technology	V 3.0.2 2021. 4. 27.	pdf 6.6 MB	Download
System Manual Series 750/753 Online HTML		URL	Download

Bid Text

750-466/025-000	2019. 2. 19.	xml	Download
-----------------	--------------	-----	----------

Subject to changes. Please also observe the further product documentation!



X81 - Datei			4.6 kB	
750-466/025-000	2017. 10. 17.	doc		Download
doc - Datei			30.2 kB	

Additional Information

Disposal; Electrical and electronic equipment, Packaging	V 1.0.0	pdf	265.8 kB	Download
--	---------	-----	----------	----------

System Description

750/753 Series I/O-System – General Product Information		pdf	1.7 MB	Download
Use in Hazardous Environments Term definition, marking and installation regulations	V 1.0.0	pdf	1.0 MB	Download
Overview on WAGO-I/O-SYSTEM 750 approvals		pdf	780.2 kB	Download

CAD/CAE-Data

CAE data

EPLAN Data Portal 750-466/025-000		URL		Download
WSCAD Universe 750-466/025-000		URL		Download
WSCAD Universe 750-466/025-000		URL		Download
EPLAN Data Portal 750-466/025-000		URL		Download
ZUKEN Portal 750-466/025-000		URL		Download

CAD data

2D/3D Models 750-466/025-000		URL		Download
------------------------------	--	-----	--	----------

Device Files

Device Driver

WAGO USB Service Kabel Treiber / Serie 750 und 857	6.5.3.0	zip		Download
--	---------	-----	--	----------

Subject to changes. Please also observe the further product documentation!



Environmental Product Compliance

Compliance Search

Environmental Product Compliance 750-466/025-000

URL

Download

2-channel analog input; 4 ... 20 mA; Single-ended; Ext. Temperature

Installation Notes

Product family

750/753 Series I/O System

[Show all products from the family](#)

Subject to changes. Please also observe the further product documentation!

WAGO Kontakttechnik GmbH & Co. KG

Hansastr. 27

32423 Minden

Phone: +49571 887-0 | Fax: +49571 887-169

Email: info.de@wago.com | Web: www.wago.com

Do you have any questions about our products?

We are always happy to take your call at +49 (571) 887-44222.