

## DETAILS

<b>Product Number</b>	C13233_HB-2X2-M
<b>Family</b>	HighBay
<b>Type</b>	Lens array
<b>Color</b>	clear
<b>Diameter</b>	50x50 mm
<b>Height</b>	8,5 mm
<b>Style</b>	square
<b>Optic Material</b>	PMMA
<b>Holder Material</b>	
<b>Fastening</b>	glue, screw, pin
<b>Status</b>	production ready
<b>ROHS Compliant</b>	Yes
<b>Date Updated</b>	21/04/2016



## OPTICAL PROPERTIES

LED	Viewing	Light	Effi-	cd/lm	Connector
	Angle	Beam	ciency		
XT-E	25 deg	Medium	92 %	3.700	-
XP-G	31 deg	Medium	91 %	3.100	-
XP-G2	33 deg	Medium	93 %	3.400	-
XB-D	26 deg	Medium	95 %	3.900	-
XQ-E HI	sim: 22	Medium	sim: 93 %	sim: 5.500	-
XP-G3	30 deg	Medium	94 %	2.700	-
H35C1 (LEMWA33)	29 deg	Medium	91 %	3.400	-
LUXEON Z ES	21 deg	Medium	91 %	5.640	-
LUXEON Q	26 deg	Medium	94 %	3.600	-
LUXEON 3030 2D	sim: 28	Medium	sim: 94 %	sim: 3.600	-
NVSxx19B/NVSxx19C	29 deg	Medium	91 %	3.100	-
NVSxx19B/NVSxx19C	29 deg	Medium	90 %	3.000	-
NVSxE21A	20 deg	Medium	94 %	4.970	-
Oslon Square PC	30 deg	Medium	91 %	3.400	-
Oslon Square Gen3	30 deg	Medium	93 %	3.400	-
LH351Z	32 deg	Medium	93 %	2.900	-
LH351B	31 deg	Medium	94 %	2.800	-
Z8Y15	20 deg	Medium	89 %	4.600	-
Z8Y19	22 deg	Medium	89 %	3.800	-
TL1L4	25 deg	Medium	85 %	3.500	-
RLE G1 49x223mm 4000lm xxx EXC OT	29 deg	Medium	94 %	3.000	-
RLE G1 49x245mm 4000lm xxx EXC OT	29 deg	Medium	94 %	3.000	-
RLE G1 49x121mm 2000lm xxx EXC OT	29 deg	Medium	94 %	3.000	-
RLE G1 49x133mm 2000lm xxx EXC OT	29 deg	Medium	94 %	3.000	-

D

C

B

A

4

4

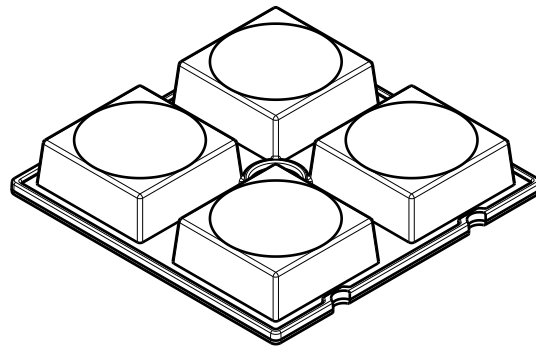
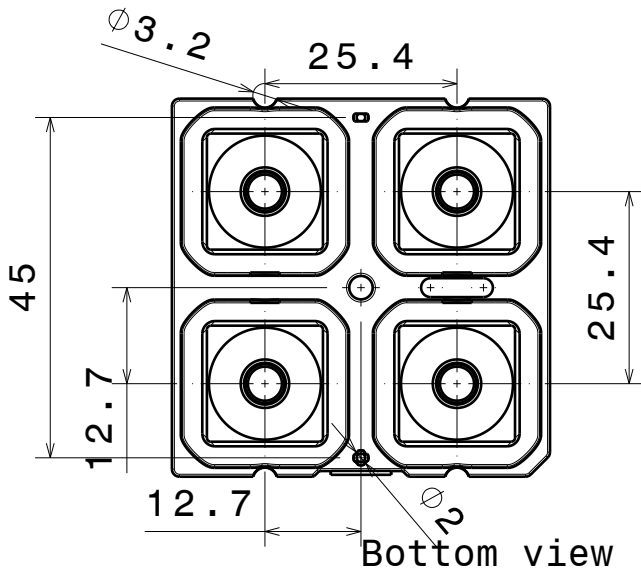

3

3

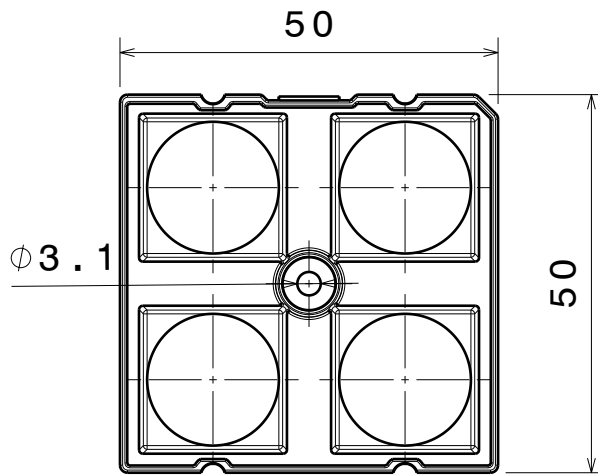
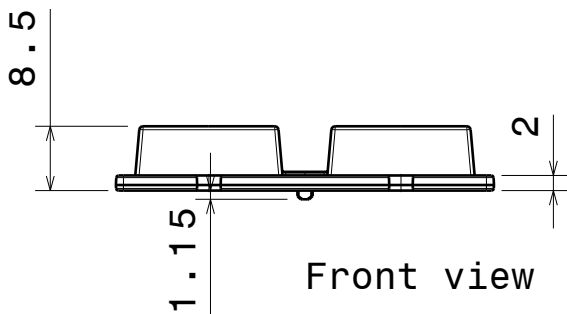

2

2

INDEX	PART NO	DESCRIPTION	MATERIAL	COLOUR
1	C13233	HB-2X2-M	PMMA	

Tolerances if not otherwise shown  
 According to DIN ISO 2768-1  
 Linear measures:  
 Up to 30mm class M, otherwise class C.  
 According to DIN ISO 2768-2  
 Form and position: class L

**LEDiL**  
 Ledil Oy  
 Salorankatu 10  
 FIN 24240 SALO  
 Finland

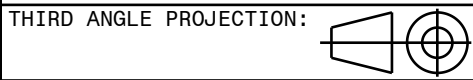

DRAWING TITLE  
**HB-2X2-M**

This drawing is the property of LEDiL Oy. It may not be reproduced, copied or communicated without a written agreement with LEDiL Oy."

SIZE  
**A4**  
**C13233**

SCALE 1:1 WEIGHT SHEET 1/1

D

A

1

1

Luminaire: Ledil Oy C13233\_HB-2x2-M (Cree XT-E 390lm @ 250mA) Efficiency=92%  
Lamps: 1 x Cree XT-E 390lm @ 250mA

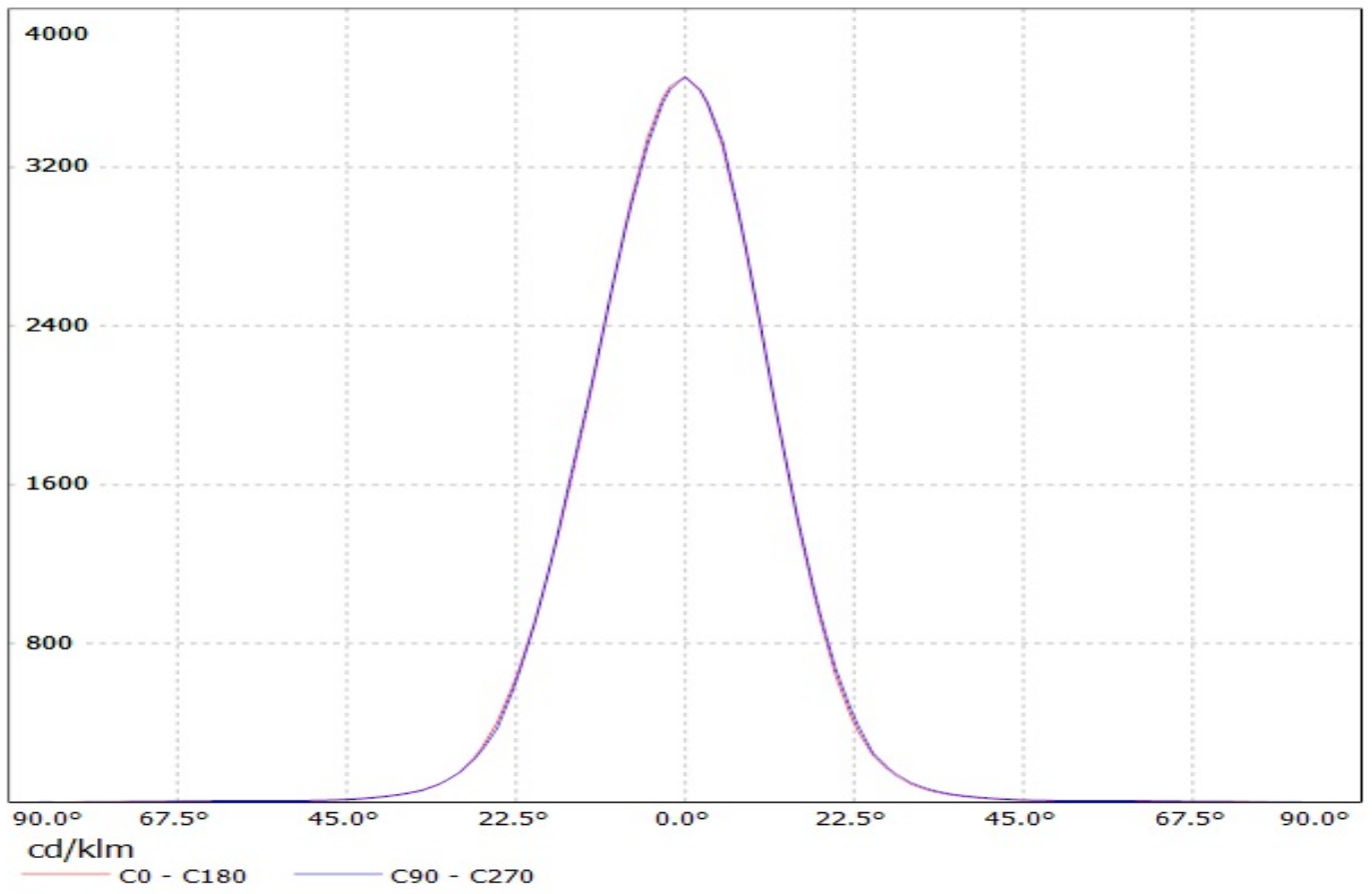

Luminaire: Ledil Oy C13233\_HB-2x2-M (Cree XP-G 257lm @ 250mA) Efficiency=91%  
Lamps: 1 x Cree XP-G 257lm @ 250mA

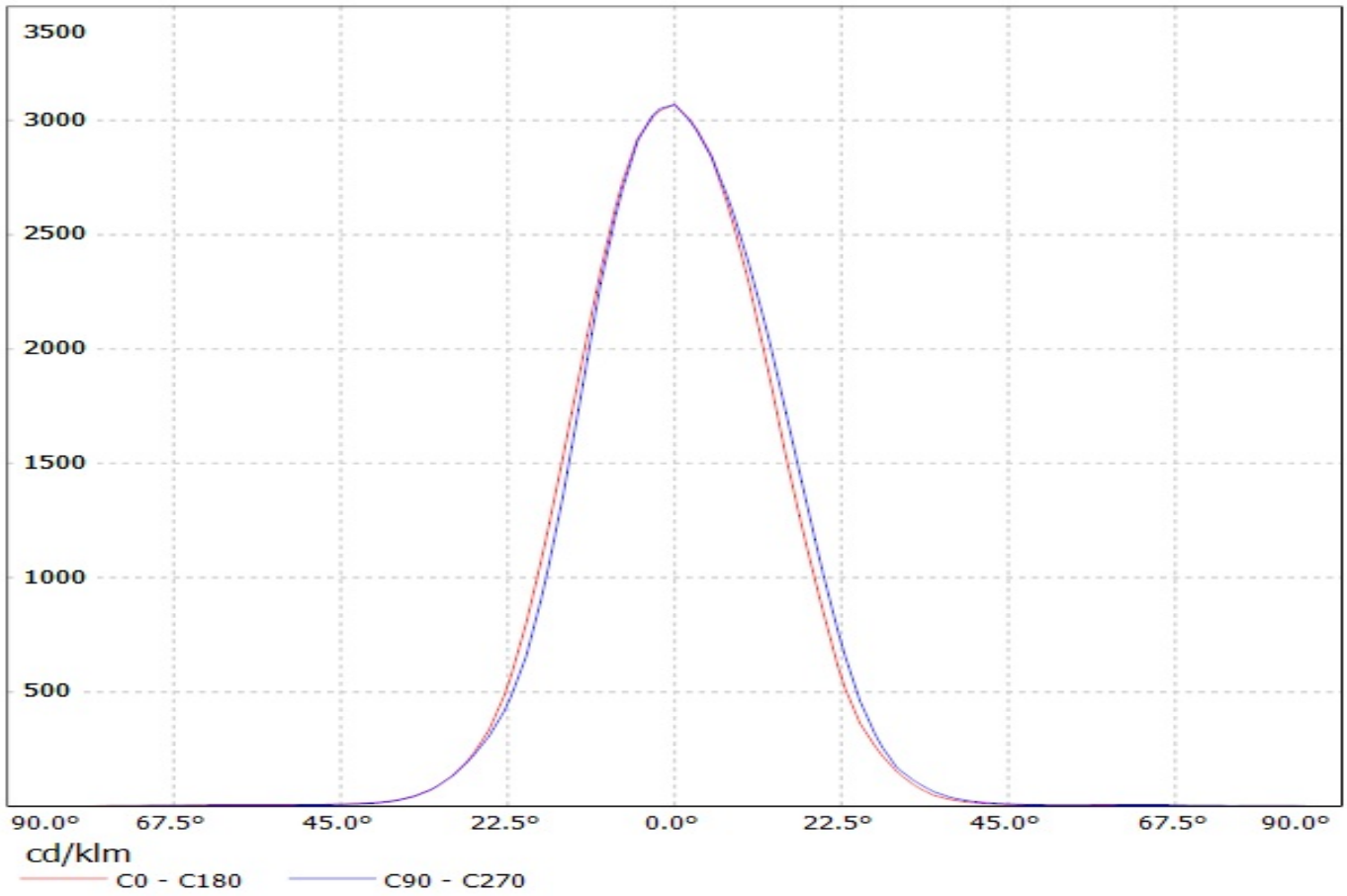

Luminaire: Ledil Oy C13233\_HB-2x2-M (Cree XP-G2 420lm @ 250mA) Efficiency=93%  
Lamps: 1 x Cree XP-G2 420lm @ 250mA

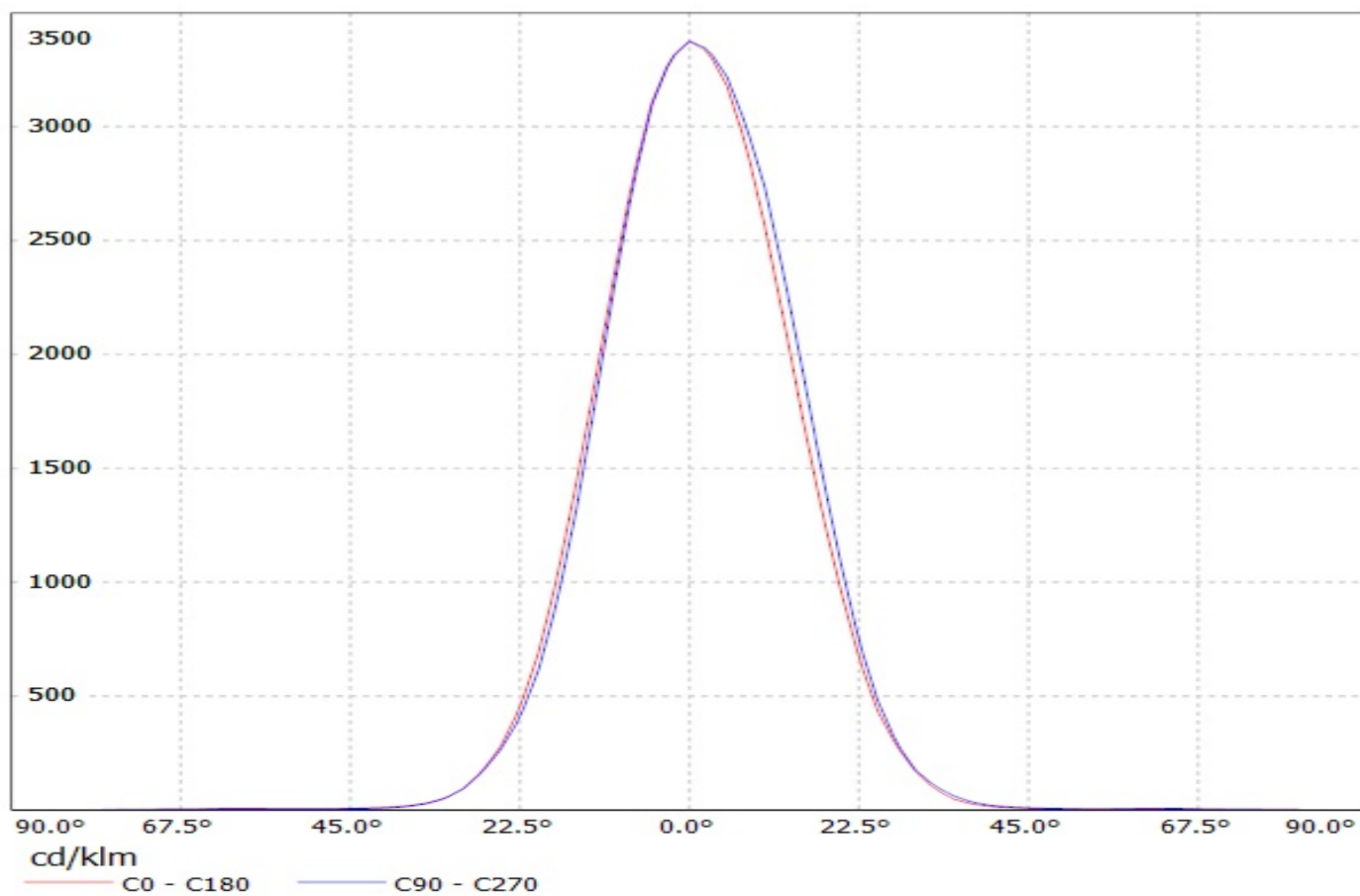

**LEDiL Oy C13233\_HB-2x2-M\_(XB-D) Eff.95.2% / LDC (Linear)**

Luminaire: LEDiL Oy C13233\_HB-2x2-M\_(XB-D) Eff.95.2%  
Lamps: 1 x CREE\_XB-D\_2x2 (362.885lm@250mA)

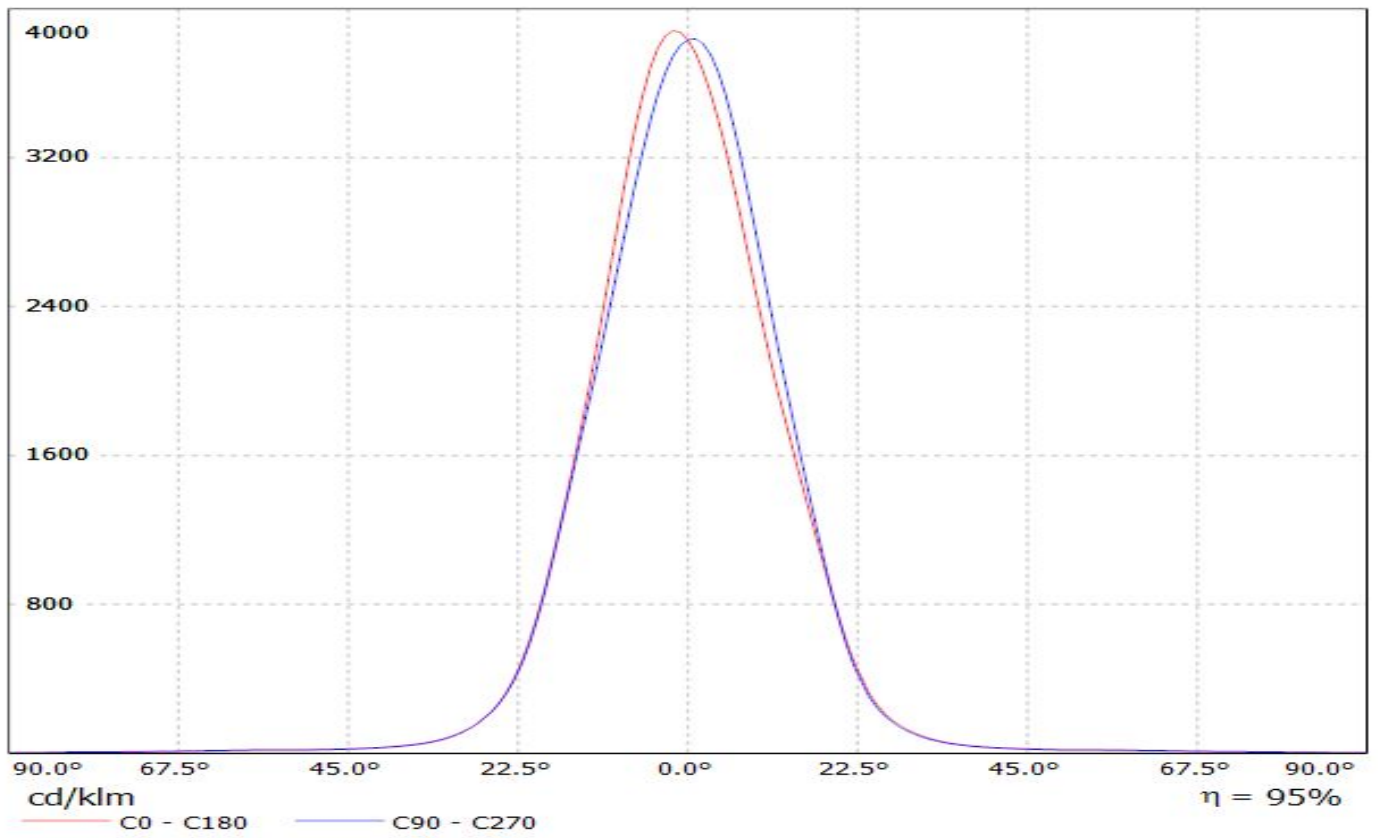

Luminaire: Ledil C13233\_HB-2x2-M (XP-G3)

Lamps: 1 x Cree\_XP-G3\_2x2\_(XPGDWT-B1-3C0-S4-0-01)\_516.459lm@250mA\_P=2.7885W\_I=0.25A

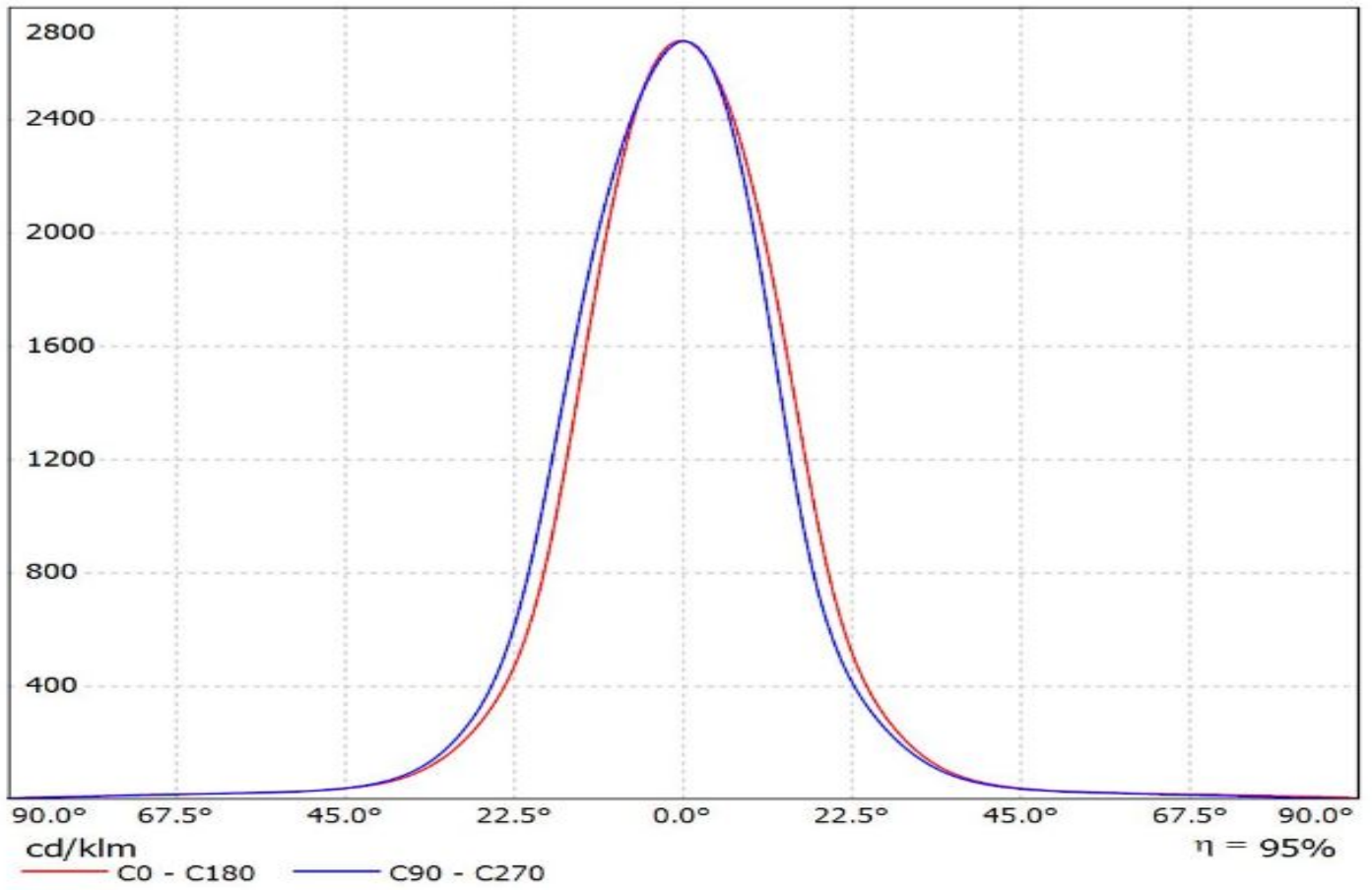

Luminaire: Ledil Oy C13233\_HB-2x2-M\_(3535\_Ceramic\_gen2) Efficiency=91%  
Lamps: 1 x LG 3535 Ceramic gen2 (PKG5700K) 461lm @ 250mA CCT=6600K P=2.9W I=250mA

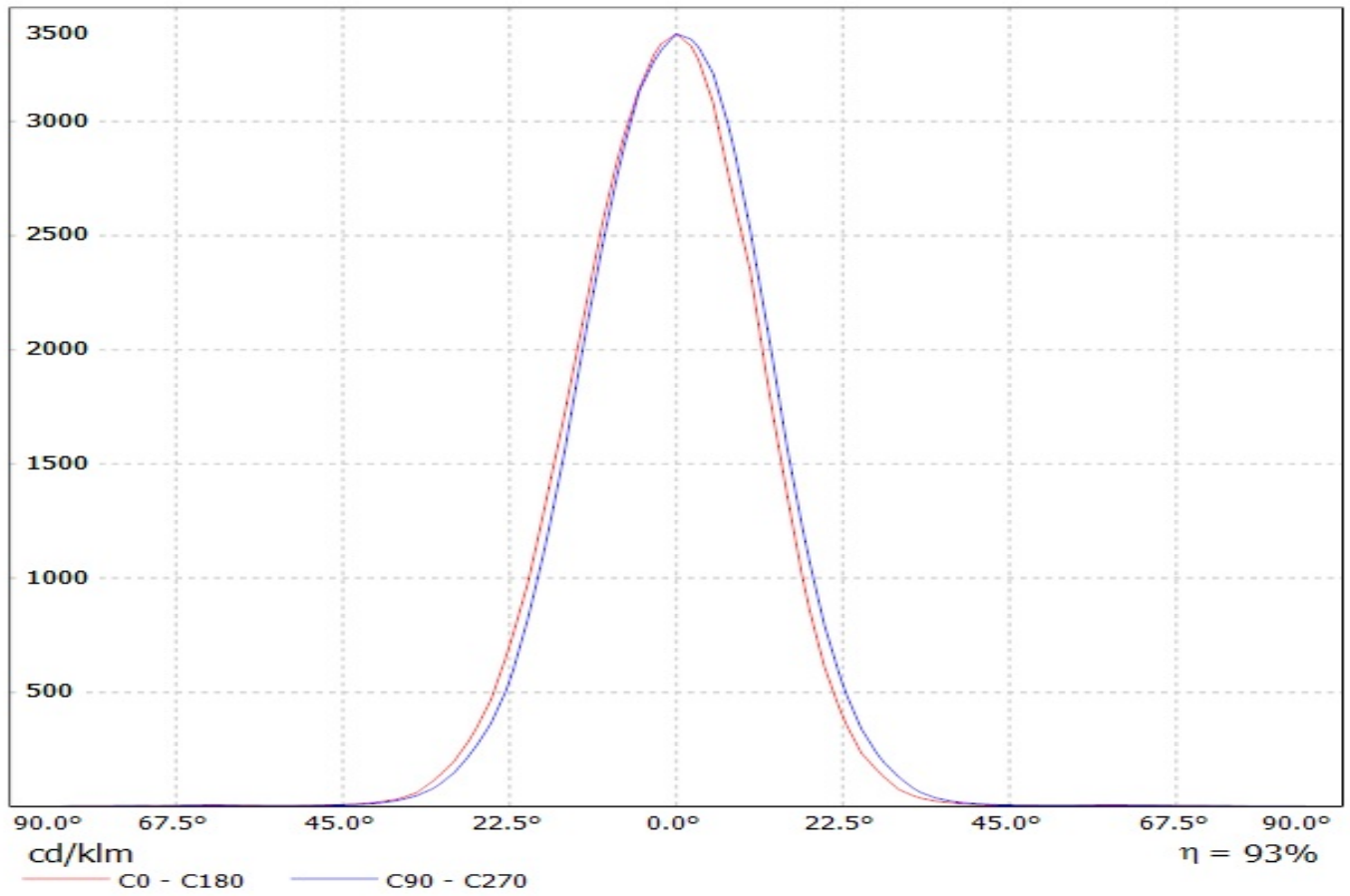

Luminaire: Ledil Oy C13233\_HB-2X2-M\_(Luxeon\_Z\_ES) Efficiency=91%  
Lamps: 1 x Luxeon Z ES (LXZ2-3090) 209lm @ 250mA CCT=3000K P=2.8W I=250mA

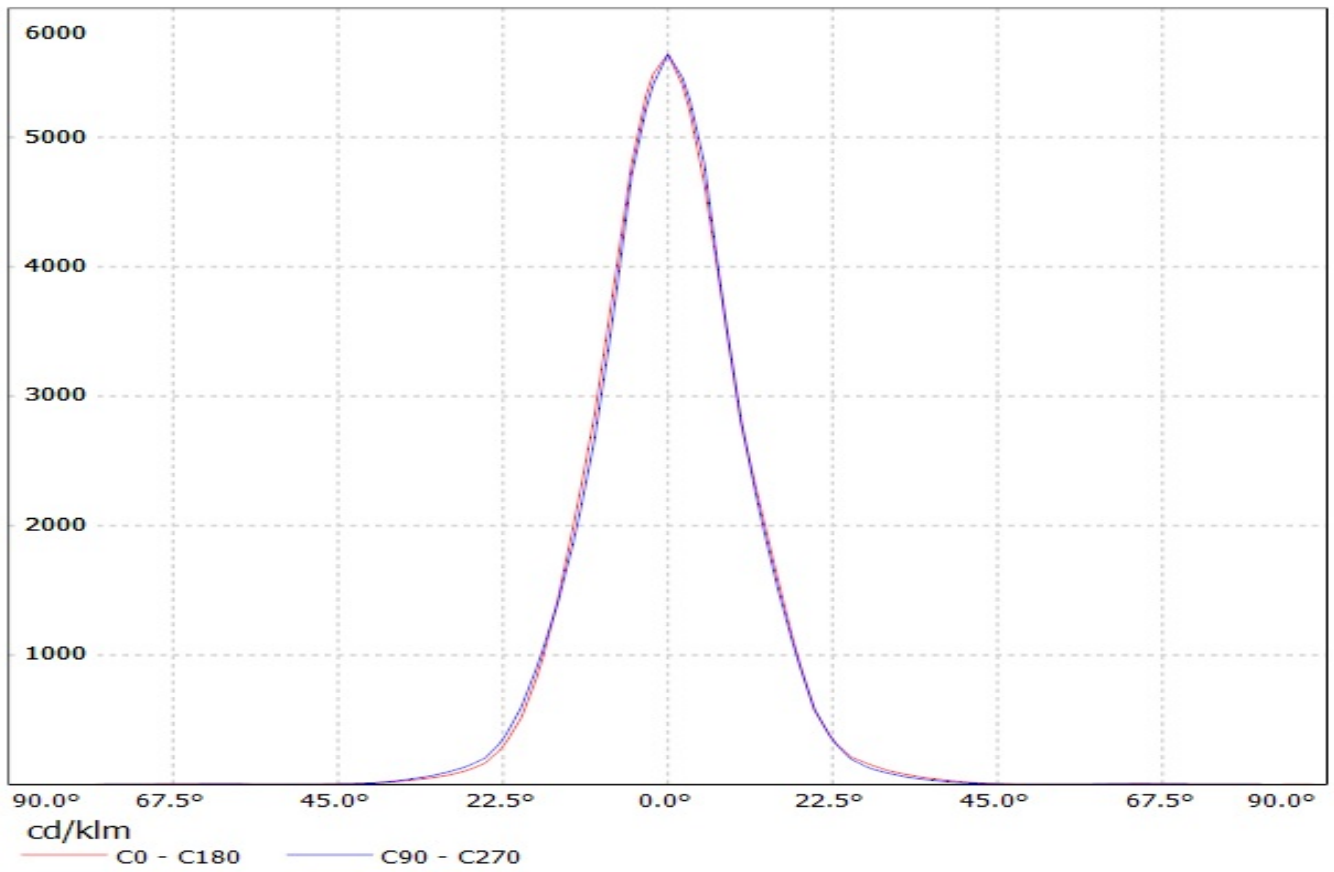

Luminaire: LEDiL Oy C13233\_HB-2X2-M\_(LUXEON\_Q) Eff.94.5%  
Lamps: 1 x LUXEON\_Q\_2x2\_(LHQ-3080)\_298.363lm@250mA\_P=2.87385W\_I=249.9mA

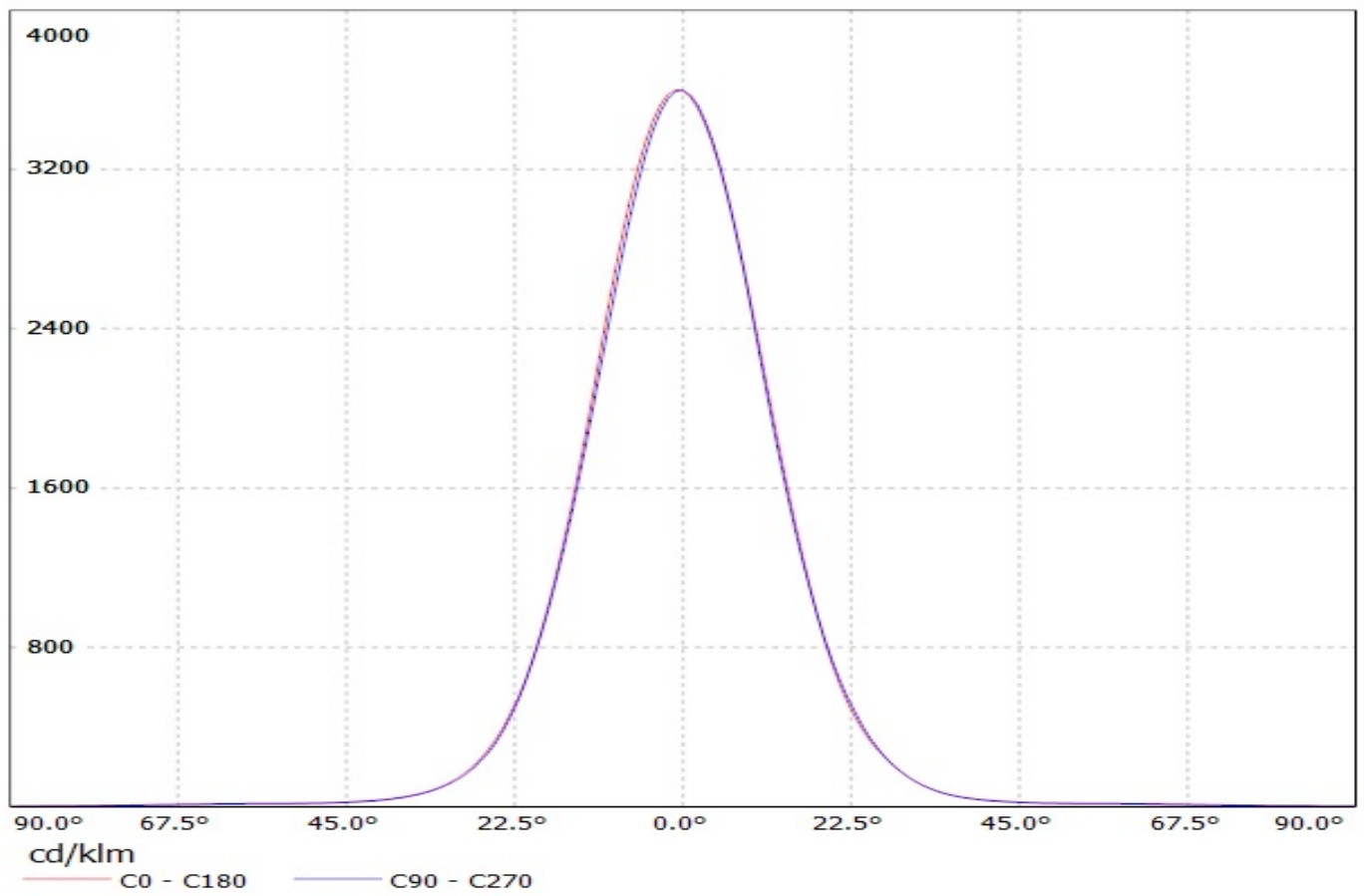

Luminaire: Ledil Oy C13233\_HB-2X2-M\_(Luxeon\_3030\_2D)\_SIMULATED  
Lamps: 1 x Lumileds Luxeon 3030 2D

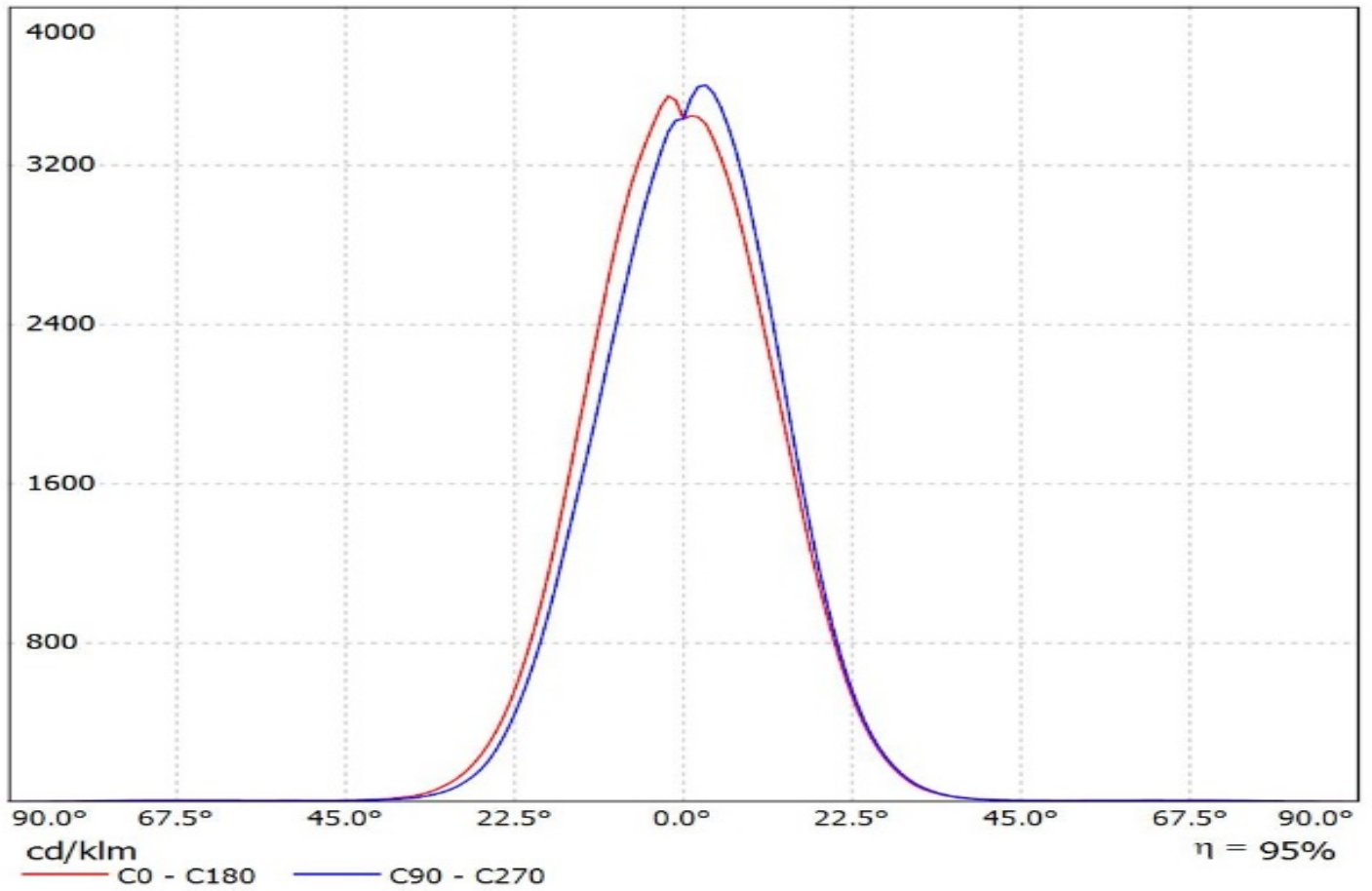

Luminaire: Ledil Oy C13233\_HB-2x2-M (Nichia 219B 306lm @ 250mA) Efficiency=91%  
Lamps: 1 x Nichia 219B 306lm @ 250mA

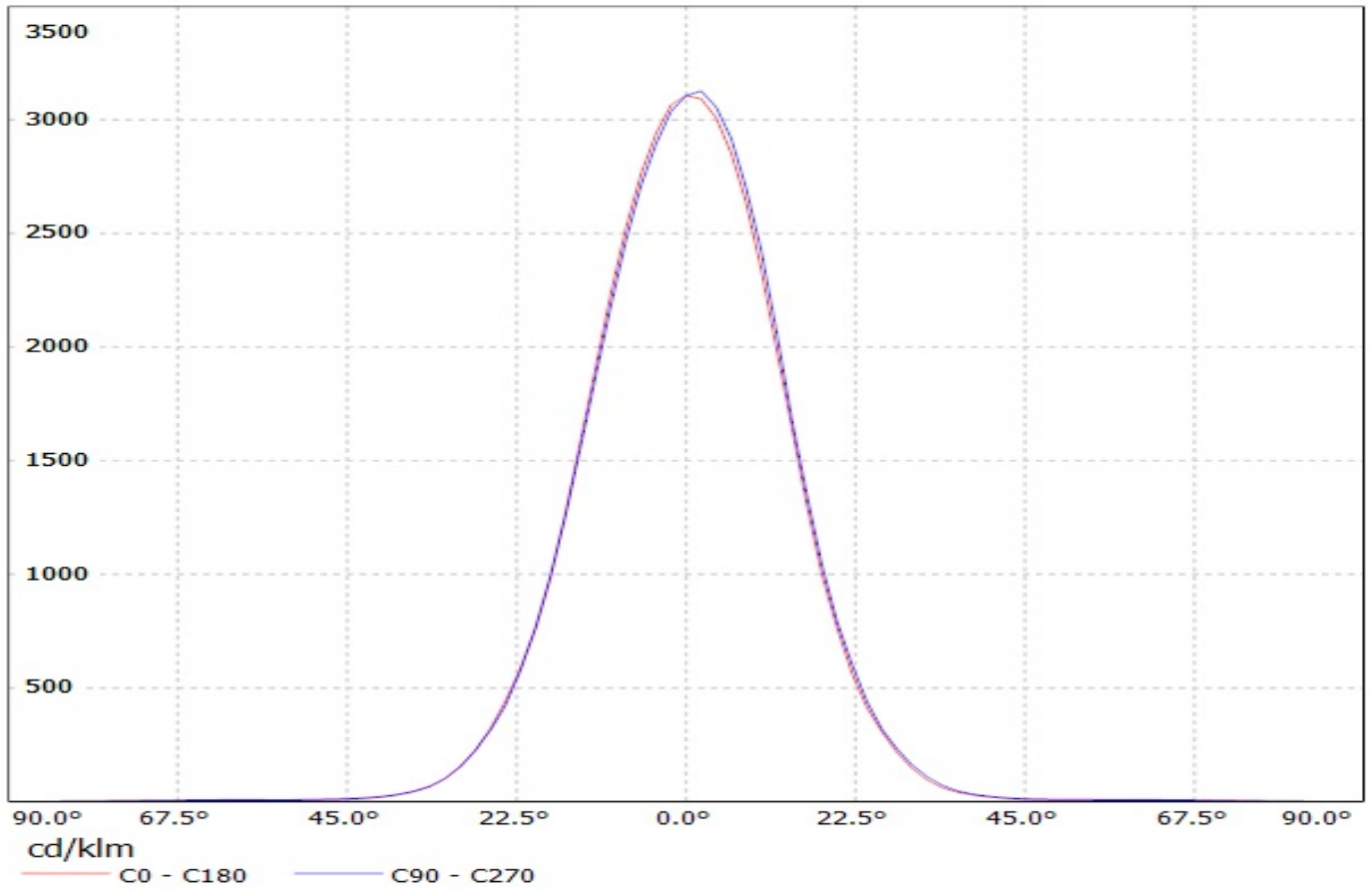

Luminaire: Ledil C13233-HB\_2x2-M\_(NVSL219CE)

Lamps: 1 x Nichia\_NVSL219CE\_496.405lm@250mA\_CCT=4000K\_P=2.8465W\_I=0.25A

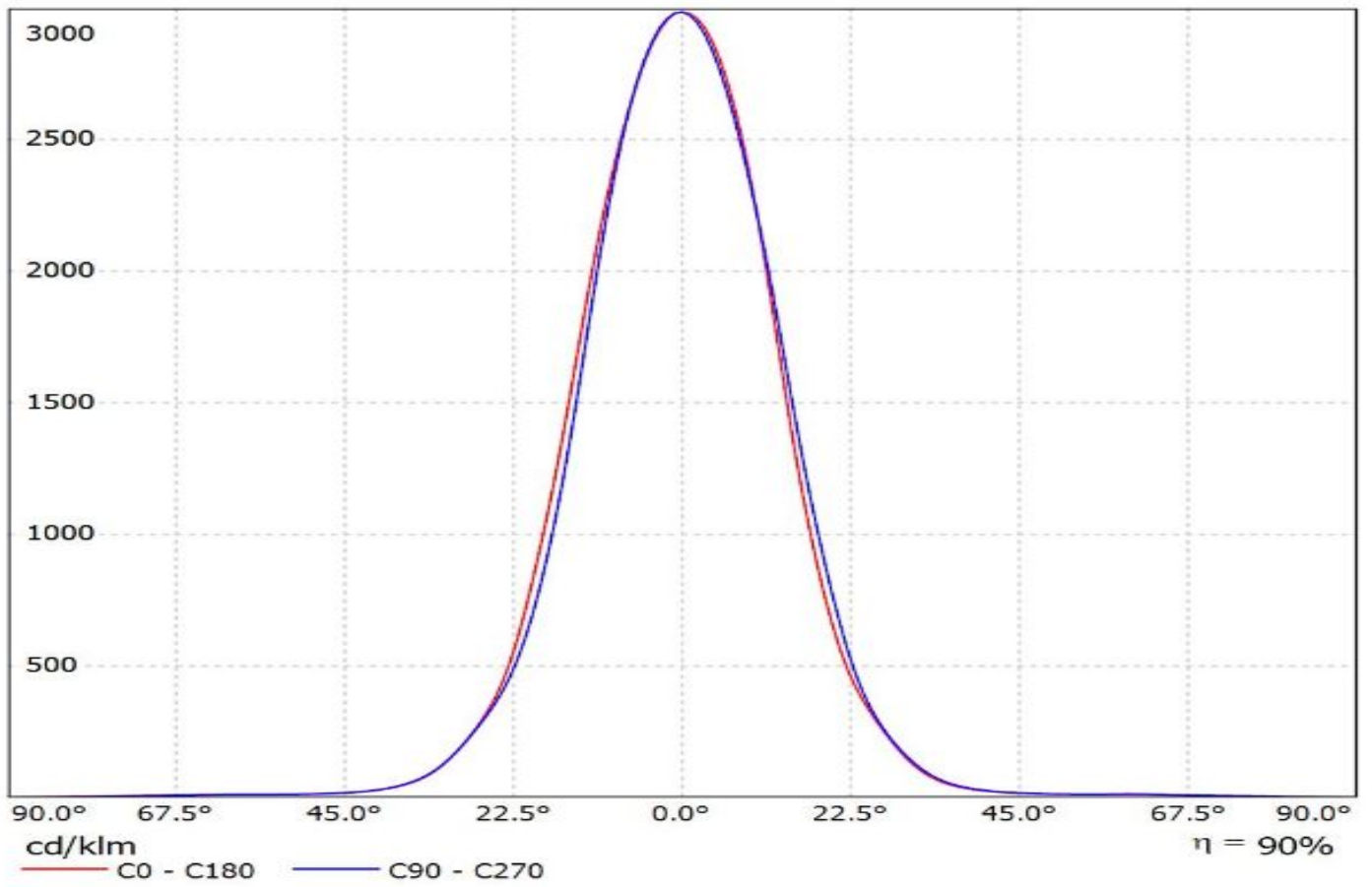

Luminaire: LEDiL Oy C13233\_HB-2X2-M\_(E21A) Nichia\_E21A\_452.248lm@250mA\_2.805W\_I=0.250A  
Lamps: 1 x Nichia\_E21A\_452.248lm@250mA\_2.805W\_I=0.250A

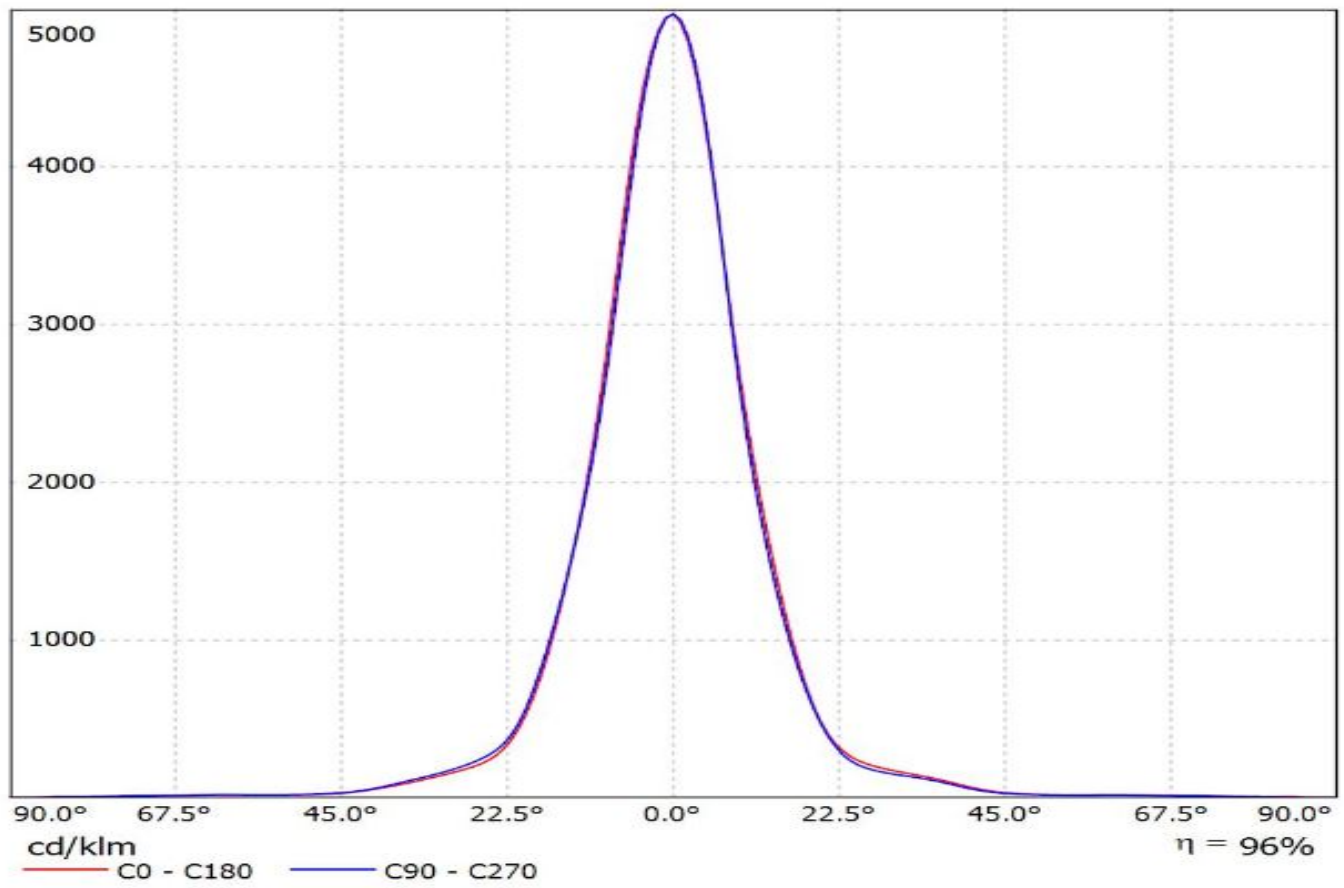

Luminaire: Ledil Oy (Osram Square PC 398lm @ 250mA) Efficiency=91%  
Lamps: 1 x Osram Square PC 398lm @ 250mA

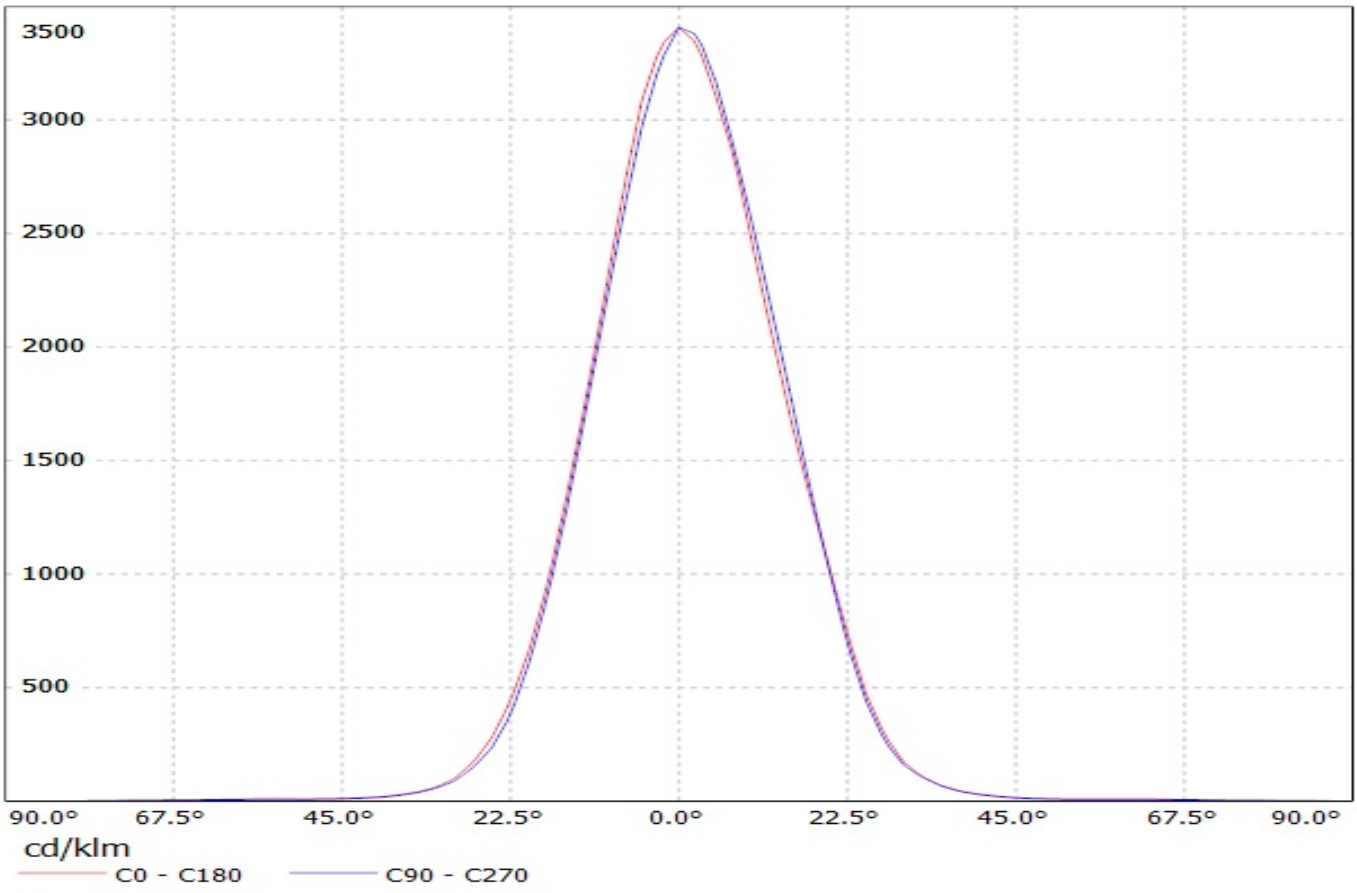

Luminaire: LEDiL Oy  
Lamps: 1 x C13233-HB-2x2-M\_(SQ\_Gen3)

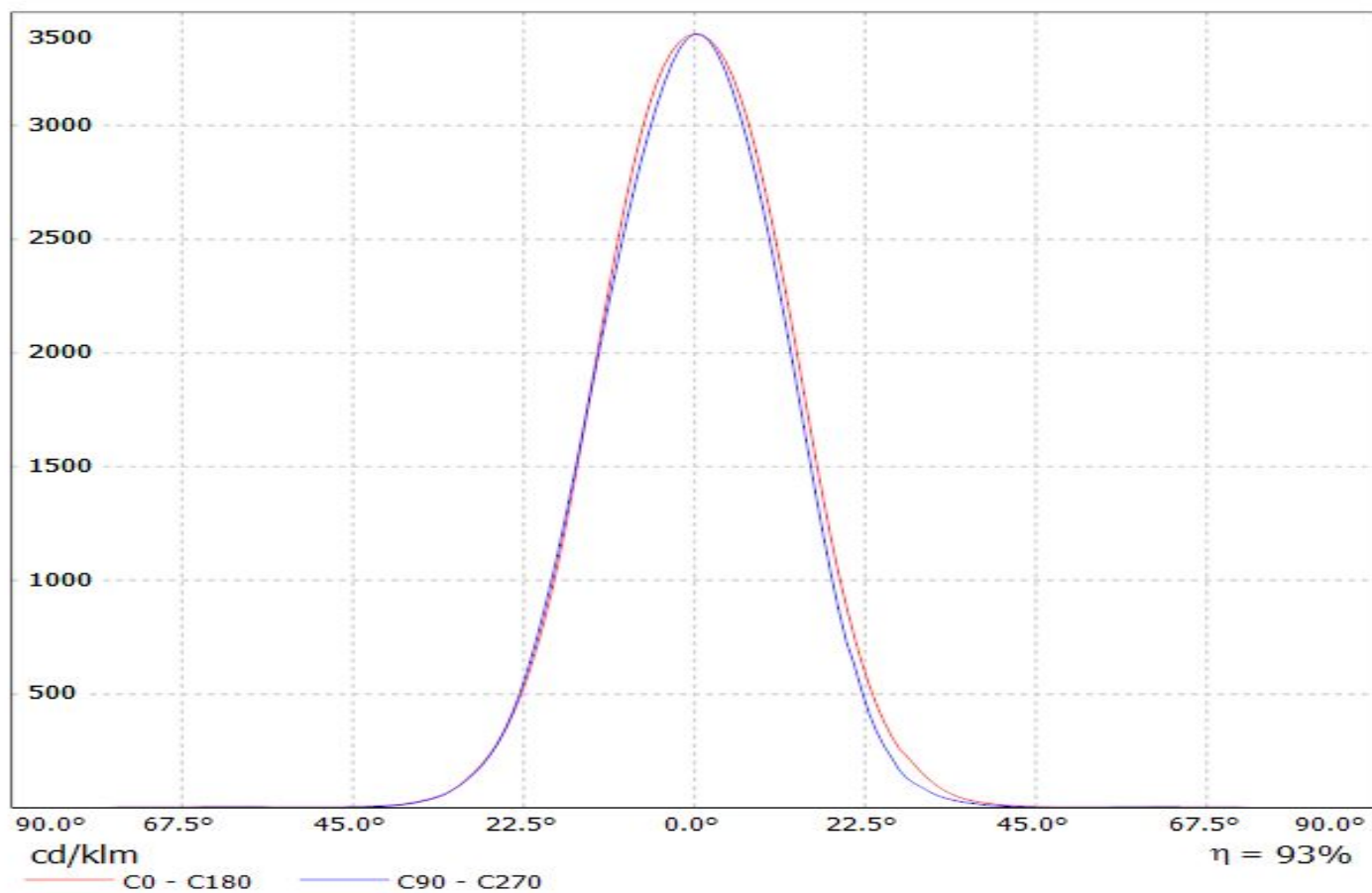

Luminaire: LEDiL Oy C13233\_HB-2X2-M\_(LH351Z) Eff.93.0%  
Lamps: 1 x SAMSUNG\_LH351Z\_2x2\_359.49lm@250mA\_P=2.86371W\_I=249.8mA

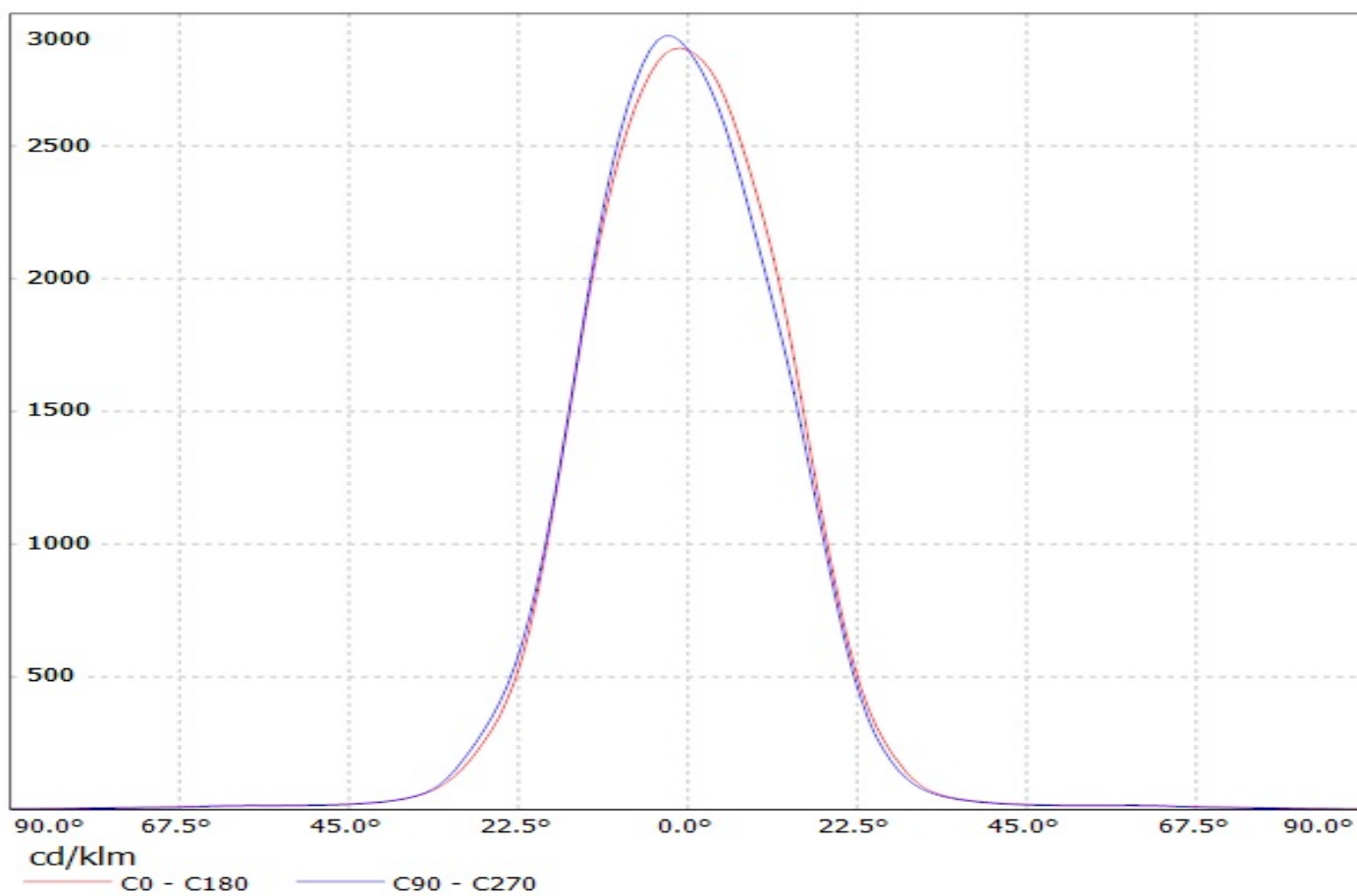

Luminaire: LEDiL Oy C13233\_HB-2X2-M\_(LH351B) Eff.93.6%  
Lamps: 1 x SAMSUNG\_LH351B\_2x2\_430.715lm@250mA\_P=2.84311W\_I=249.9mA

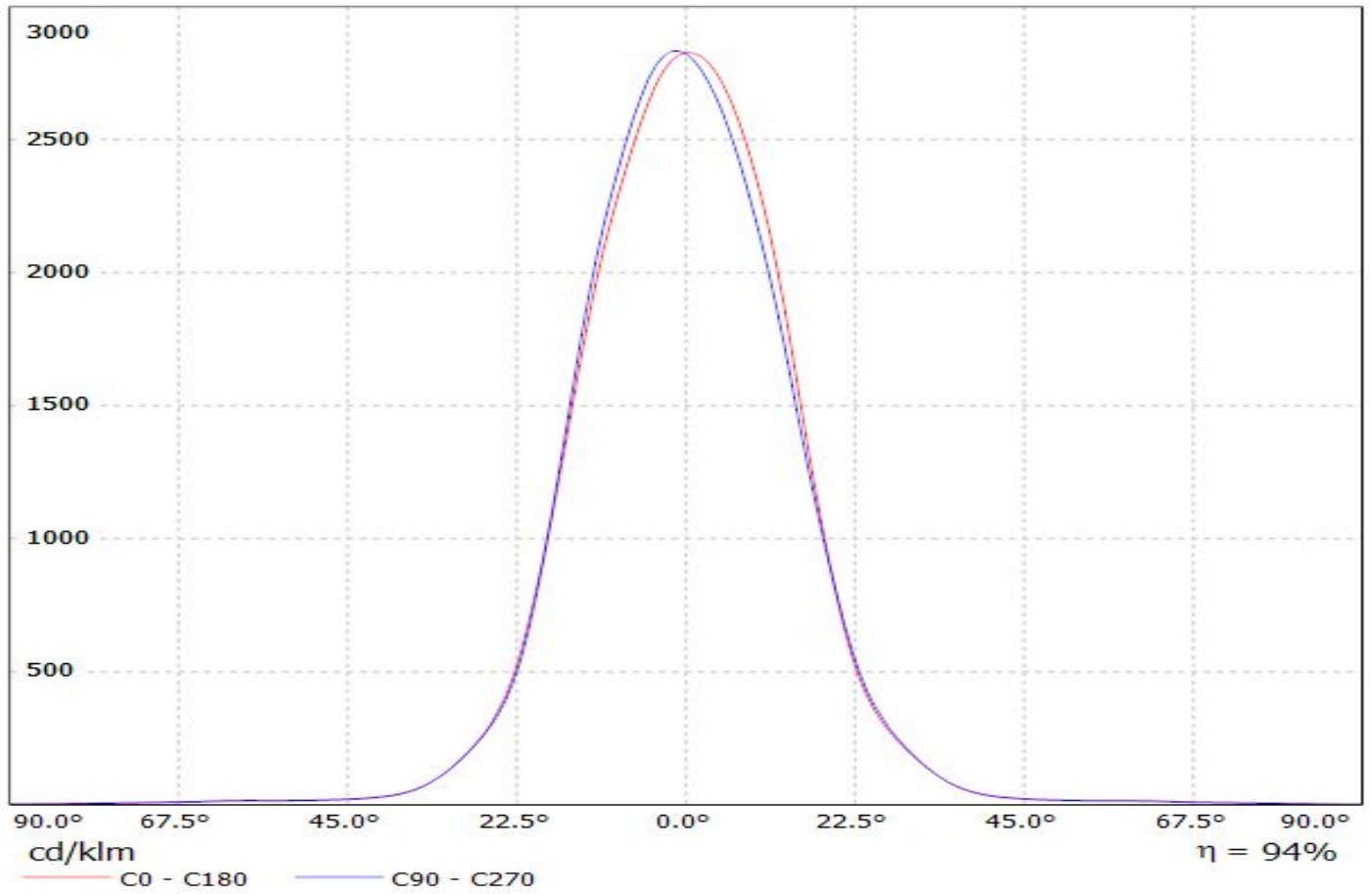

Luminaire: LEDiL Oy C13233\_HB-2X2-M\_(WICOP2\_Z8Y15)

Lamps: 1 x SEOUL\_WICOP2\_Z8Y15\_336.842lm@250mA\_P=2.9399W\_I=0.250A

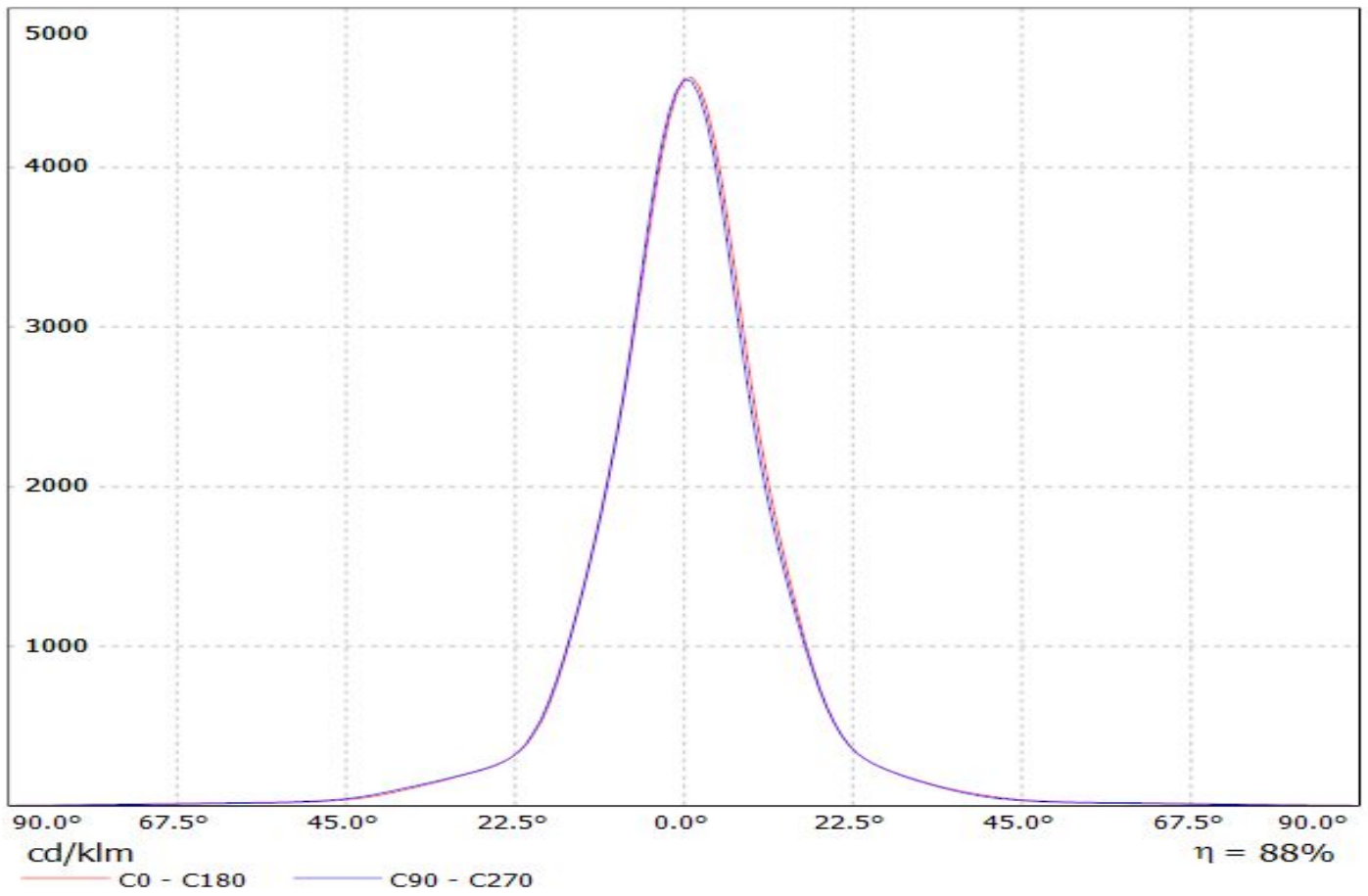

Luminaire: LEDiL Oy C13233\_HB-2X2-M\_(WICOP2\_Z8Y19)

Lamps: 1 x SEOUL\_WICOP2\_Z8Y19\_450.124lm@250mA\_P=2.8579W\_I=0.250A

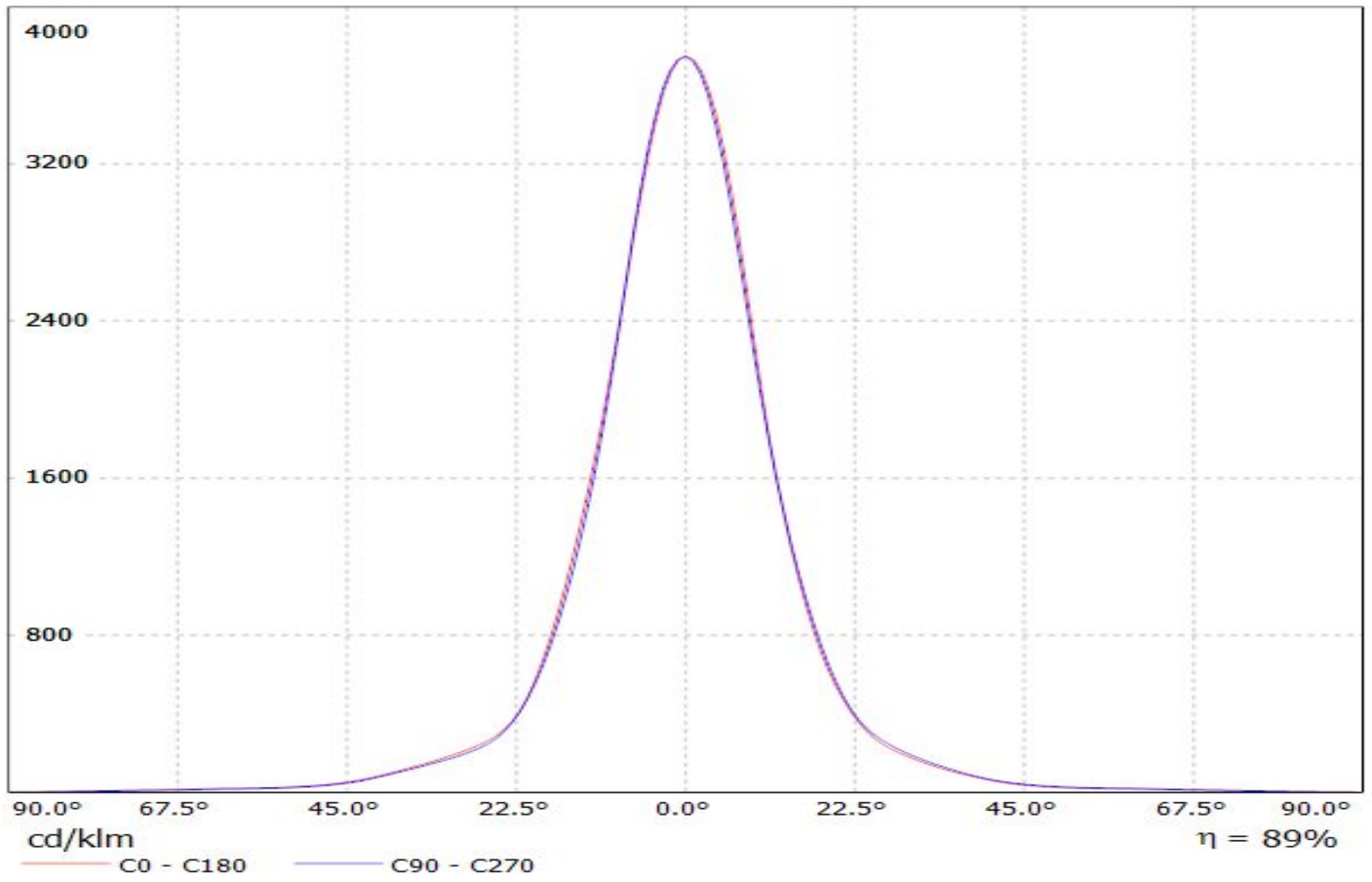

# Ledil C13233\_HB-2X2-M\_(TL1L4) / LDC (Linear)

Luminaire: Ledil C13233\_HB-2X2-M\_(TL1L4)

Lamps: 1 x Toshiba\_TL1L4\_2x2\_(TL1L4-DW0)\_472.639lm@250mA\_CCT=6500K\_P=2.9W\_I=0.25A

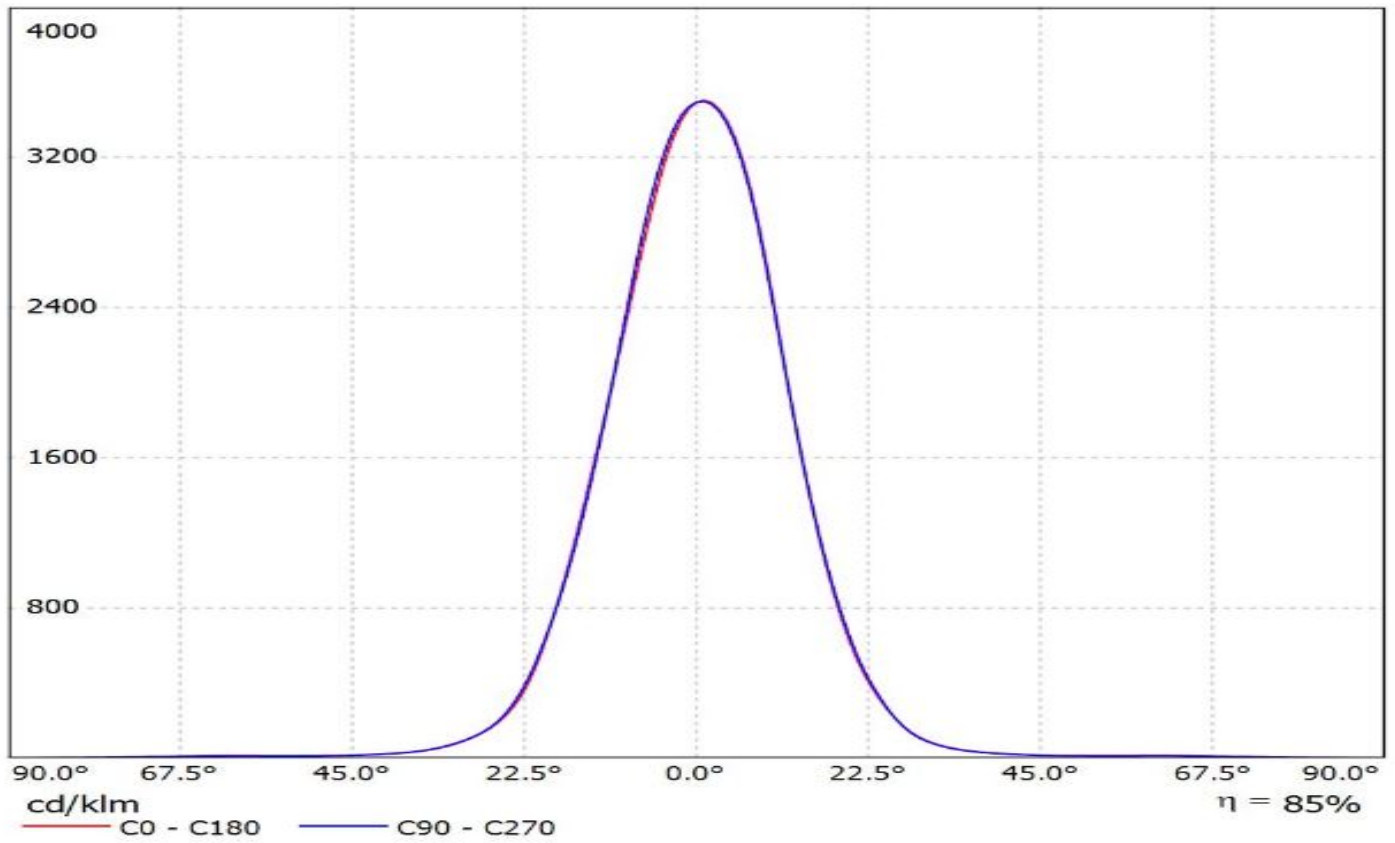

Luminaire: LEDiL Oy C13233\_HB-2X2-M\_(Tridonic\_Module\_RLE\_G1)  
Lamps: 1 x Tridonic\_Module\_RLE\_G1\_4576.03lm@700mA\_P=32.0681W\_I=0.700A

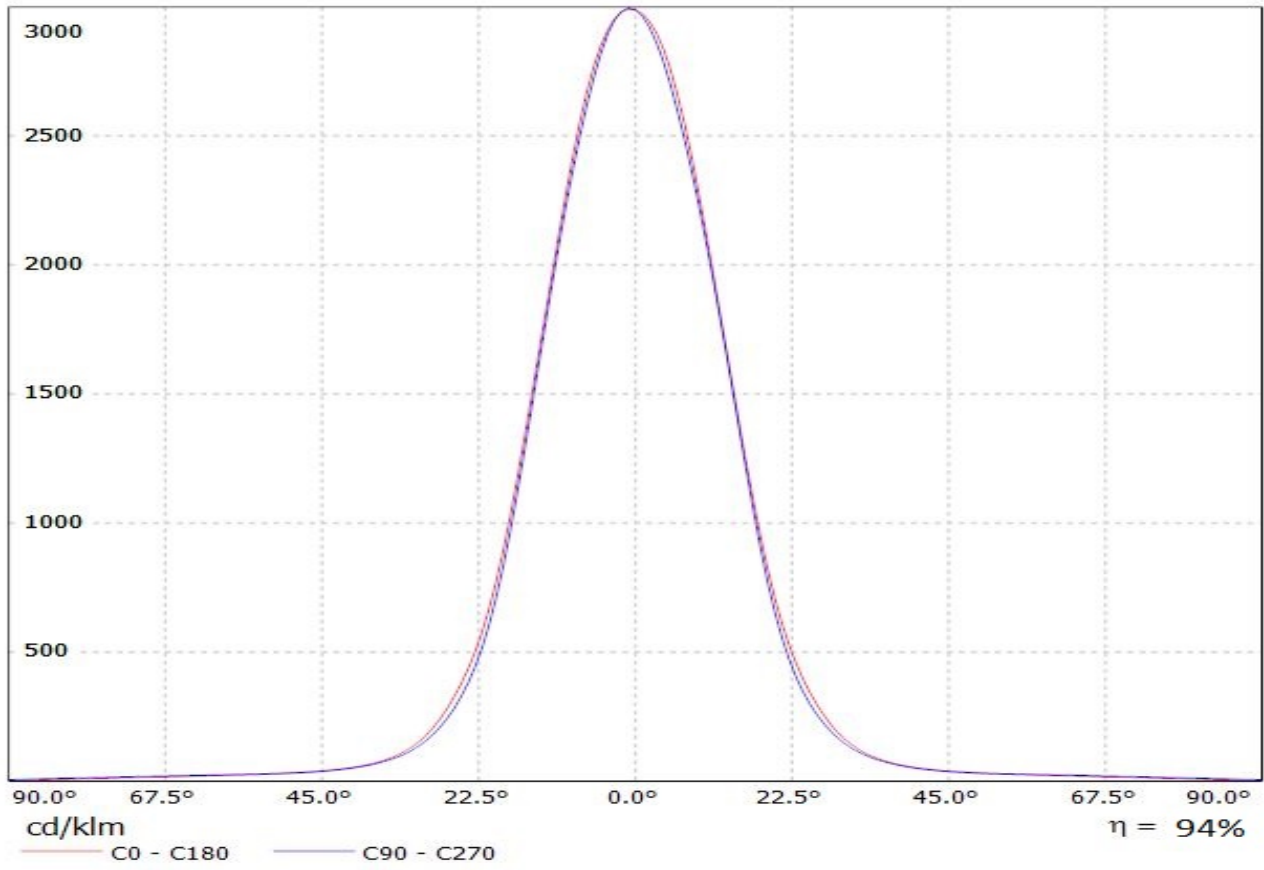

Luminaire: LEDiL Oy C13233\_HB-2X2-M\_(Tridonic\_Module\_RLE\_G1)  
Lamps: 1 x Tridonic\_Module\_RLE\_G1\_4576.03lm@700mA\_P=32.0681W\_I=0.700A

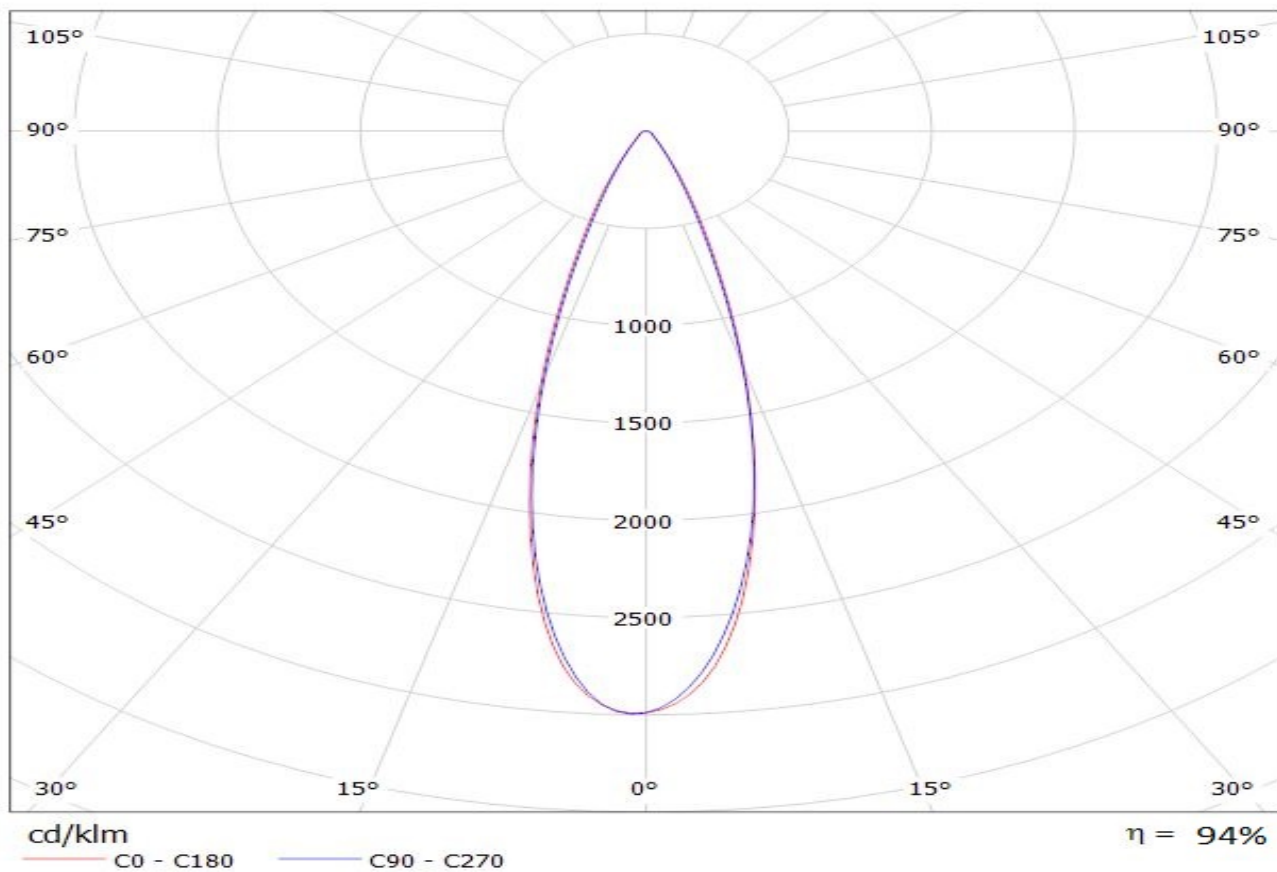

Luminaire: LEDiL Oy C13233\_HB-2X2-M\_(Tridonic\_Module\_RLE\_G1)  
Lamps: 1 x Tridonic\_Module\_RLE\_G1\_2288lm@700mA\_P=16W\_I=0.700A

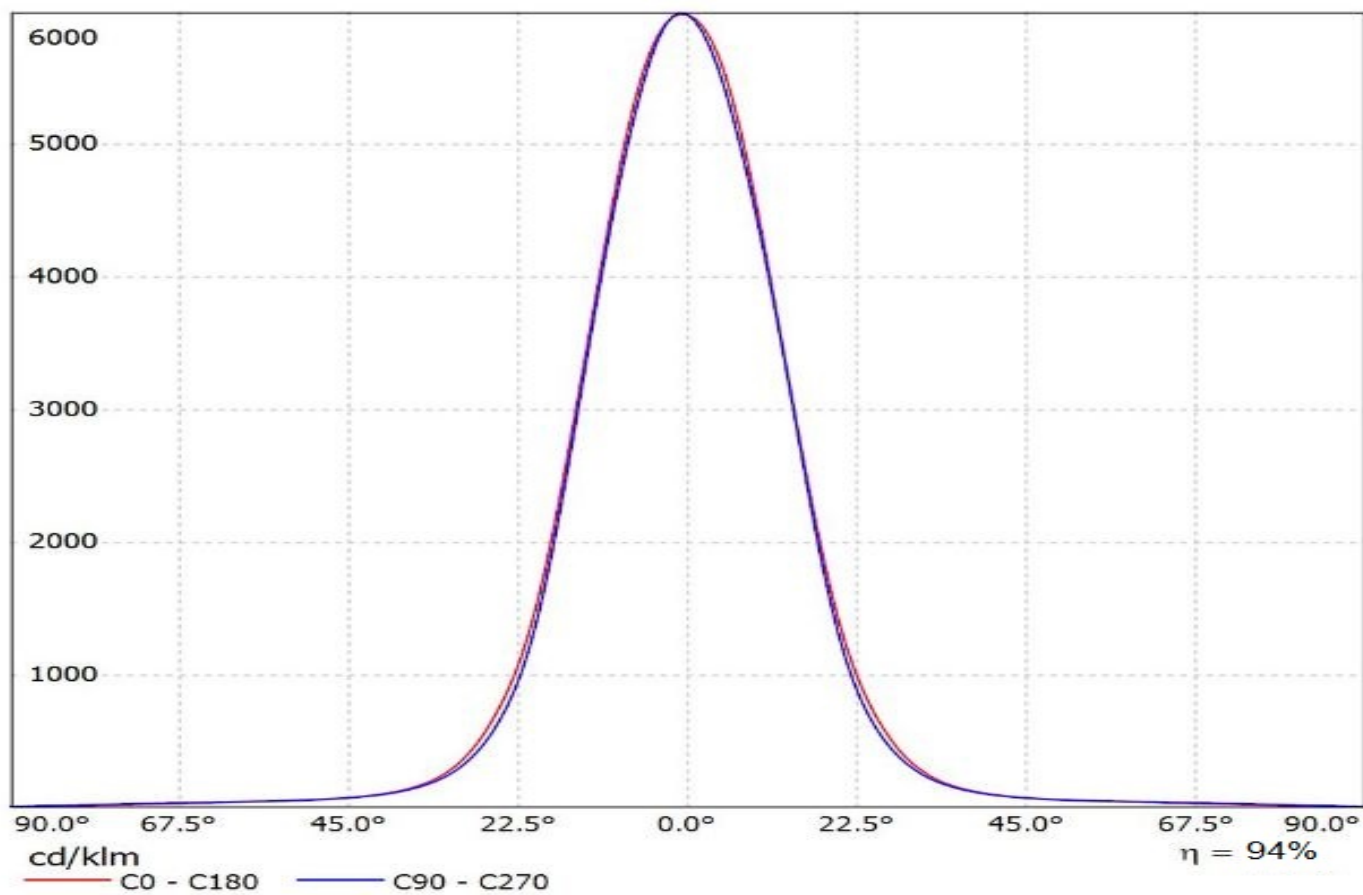

Luminaire: LEDiL Oy C13233\_HB-2X2-M\_(Tridonic\_Module\_RLE\_G1)  
Lamps: 1 x Tridonic\_Module\_RLE\_G1\_2288lm@700mA\_P=16W\_I=0.700A

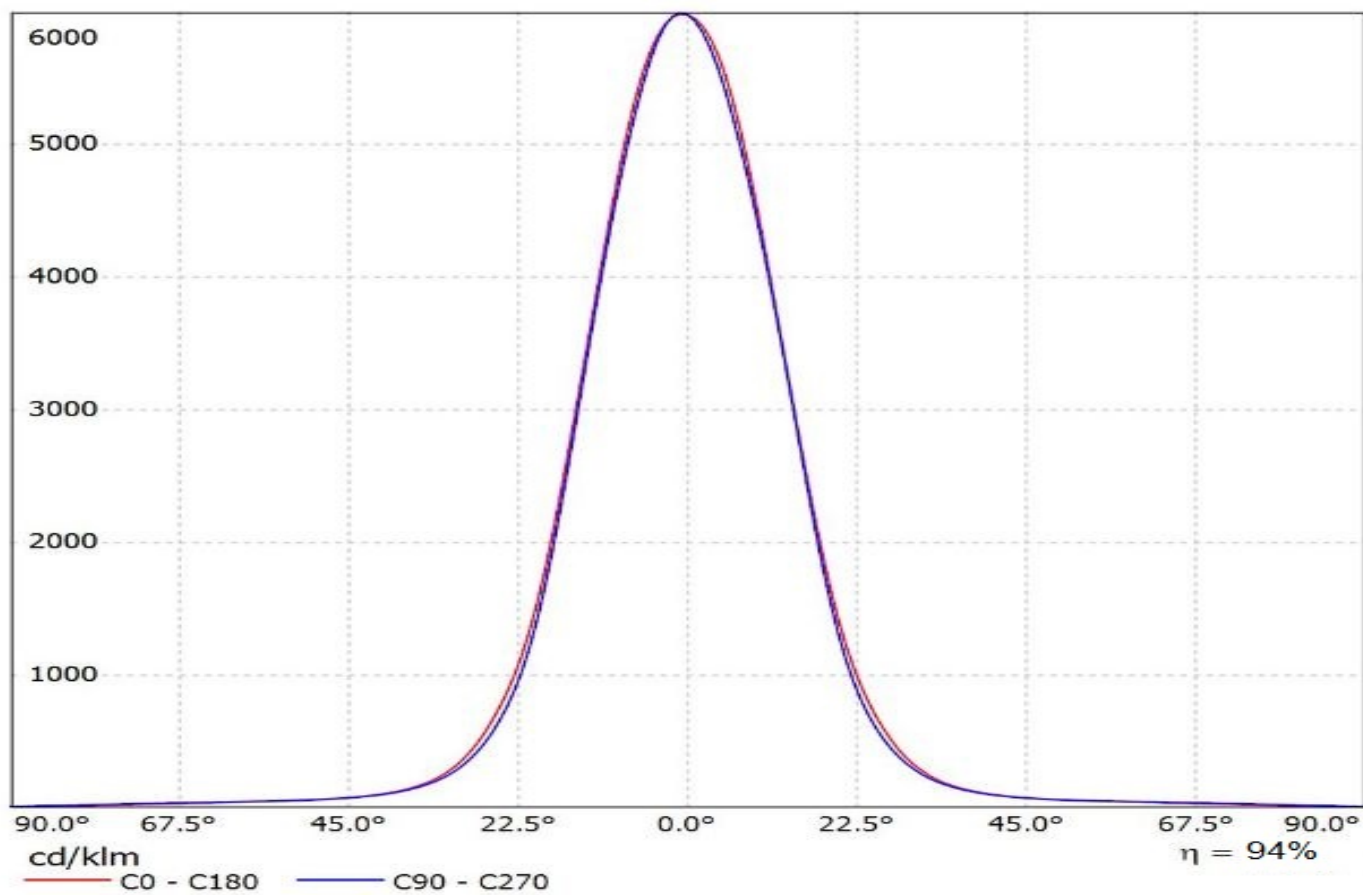

Luminaire: Ledil Oy C13233\_HB-2x2-M (Cree XT-E 390lm @ 250mA) Efficiency=92%  
Lamps: 1 x Cree XT-E 390lm @ 250mA

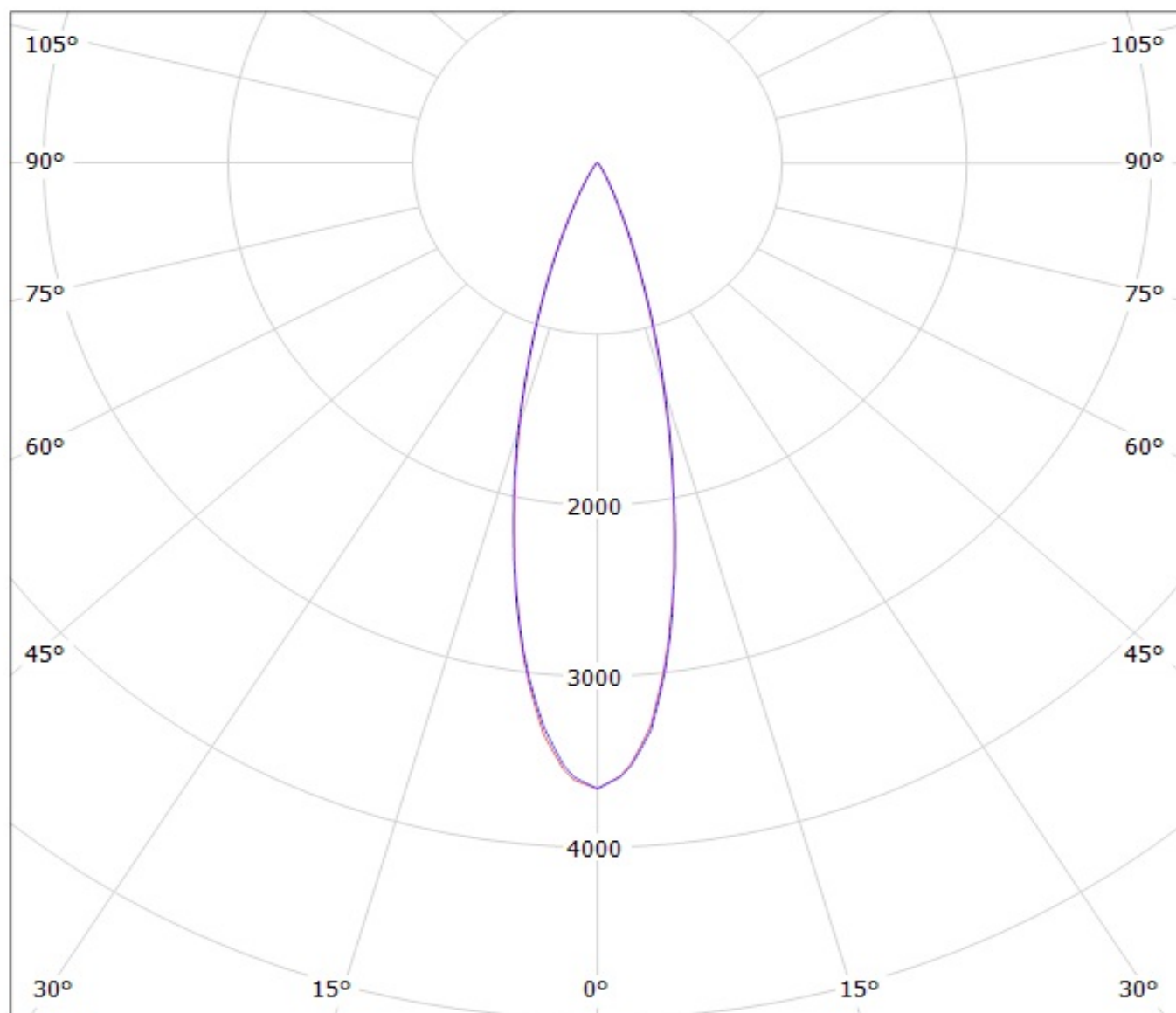

cd/klm

— C0 - C180

— C90 - C270

Luminaire: Ledil Oy C13233\_HB-2x2-M (Cree XP-G 257lm @ 250mA) Efficiency=91%  
Lamps: 1 x Cree XP-G 257lm @ 250mA

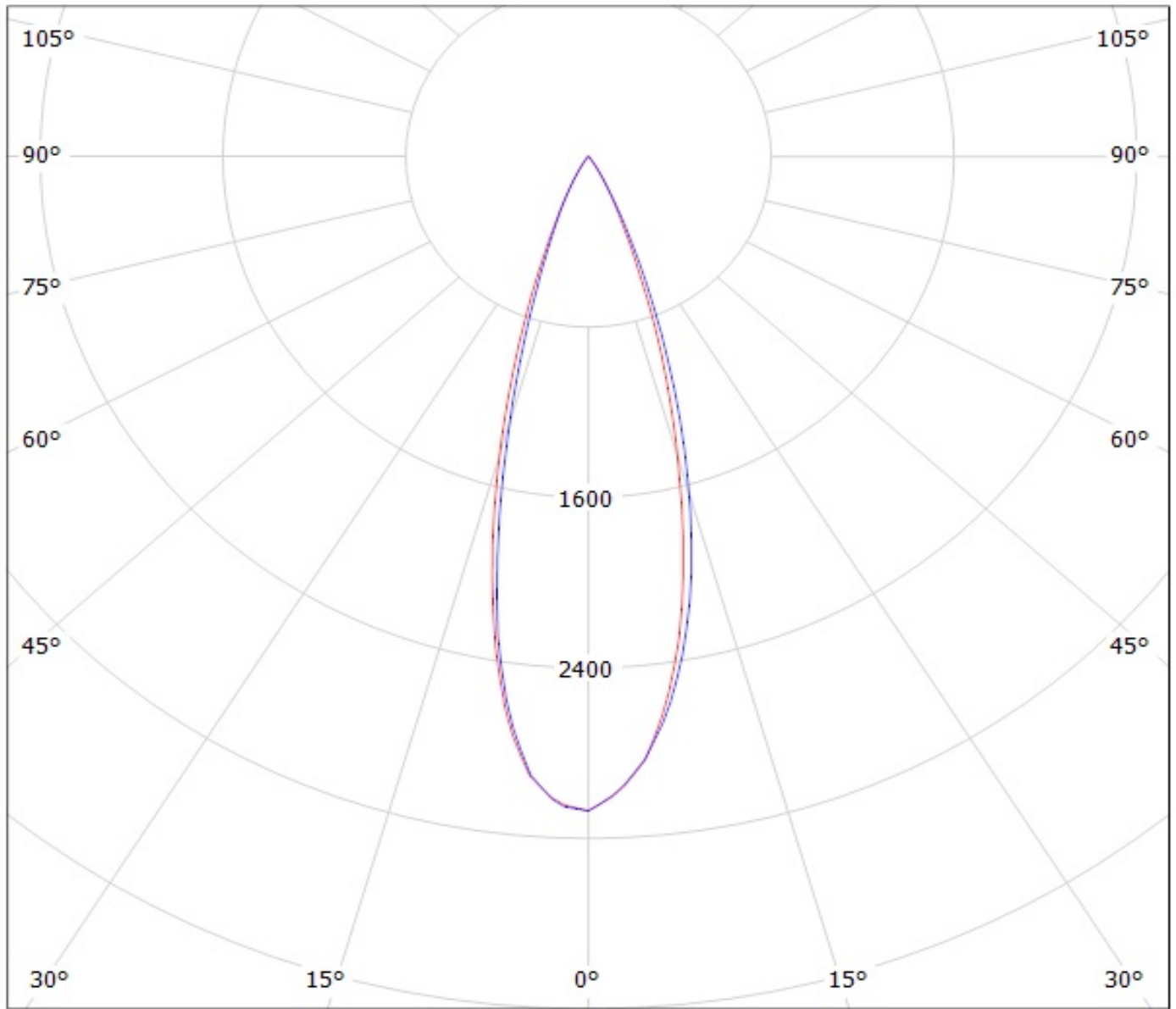

cd/klm

— C0 - C180

— C90 - C270

Luminaire: Ledil Oy C13233\_HB-2x2-M (Cree XP-G2 420lm @ 250mA) Efficiency=93%  
Lamps: 1 x Cree XP-G2 420lm @ 250mA

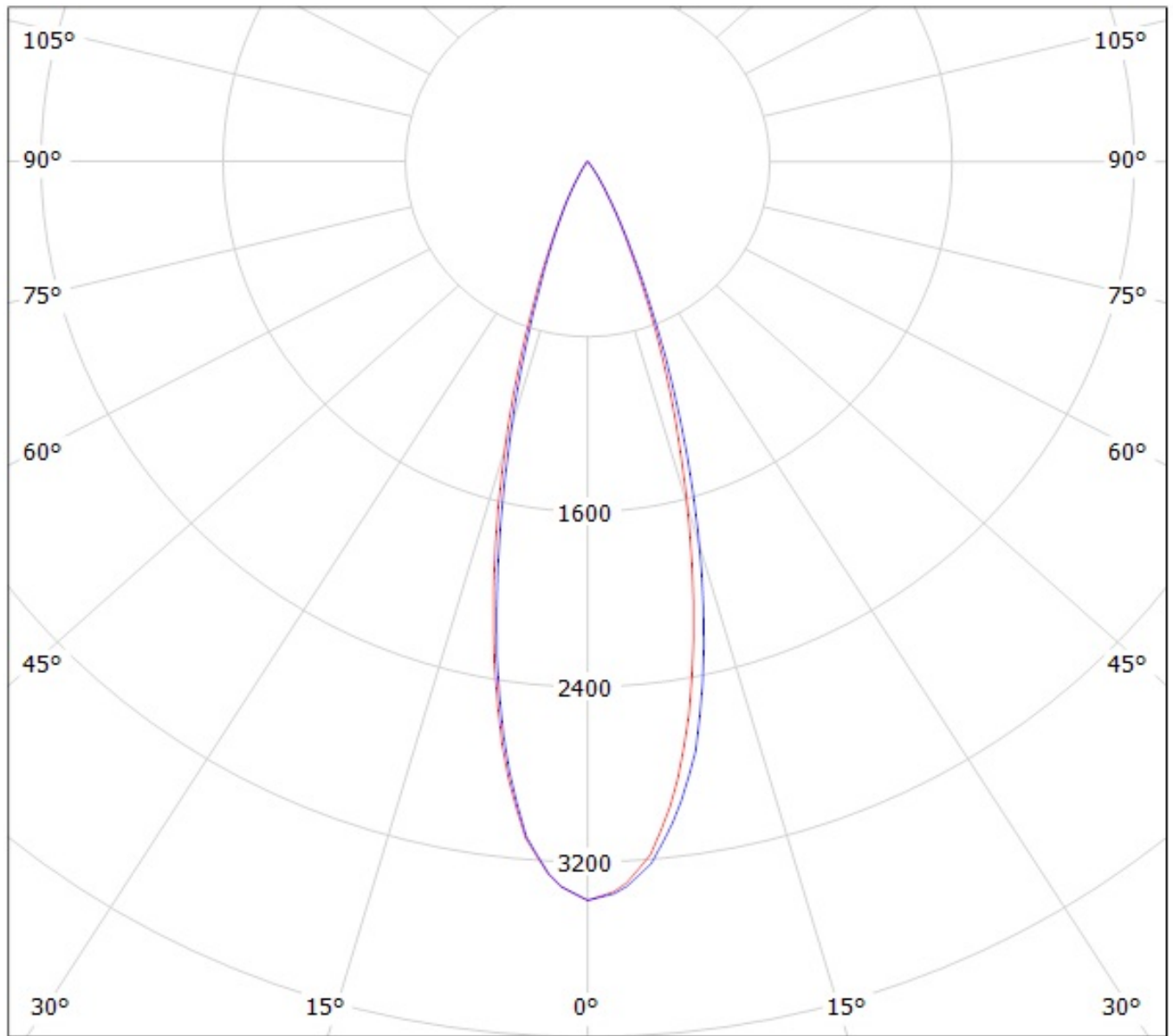

cd/klm

— C0 - C180    — C90 - C270

# LEDiL Oy C13233\_HB-2x2-M\_(XB-D) Eff.95.2% / LDC (Polar)

Luminaire: LEDiL Oy C13233\_HB-2x2-M\_(XB-D) Eff.95.2%

Lamps: 1 x CREE\_XB-D\_2x2 (362.885lm@250mA)

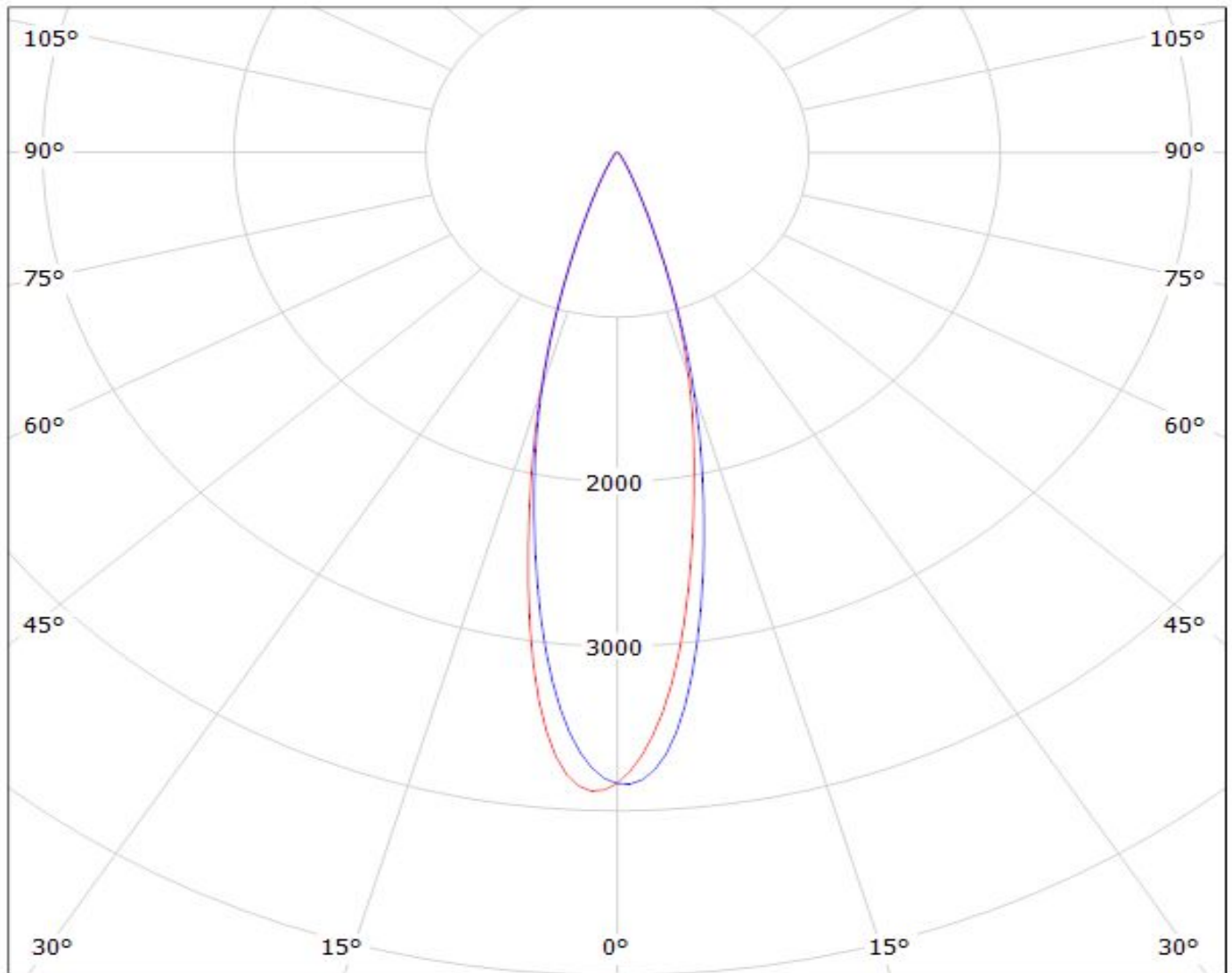

cd/klm

— C0 - C180

— C90 - C270

$\eta = 95\%$

Luminaire: Ledil C13233\_HB-2x2-M\_(XP-G3)

Lamps: 1 x Cree\_XP-G3\_2x2\_(XPGDWT-B1-3C0-S4-0-01)\_516.459lm@250mA\_P=2.7885W\_I=0.25A

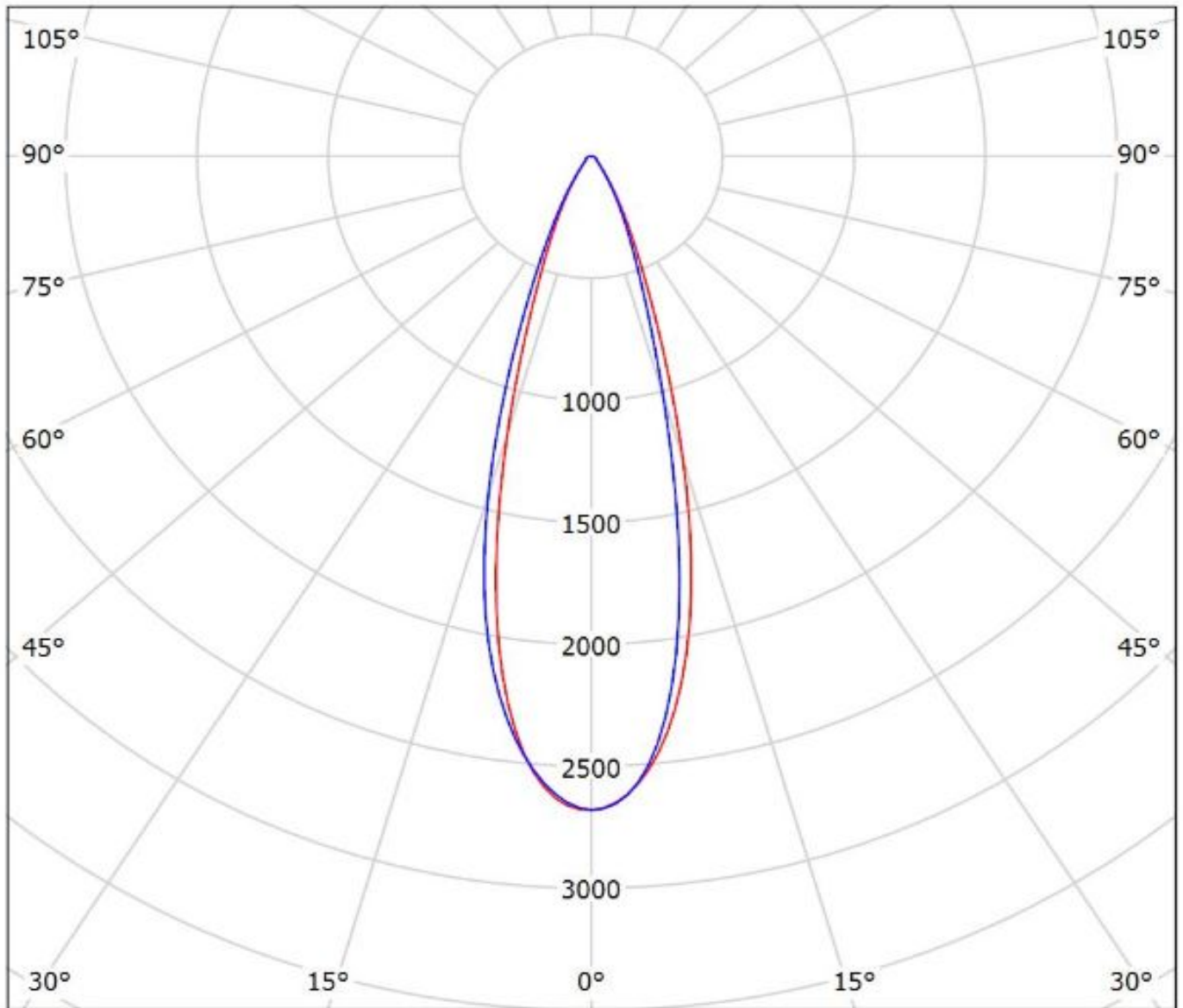

cd/klm

— C0 - C180

— C90 - C270

$\eta = 95\%$

Luminaire: Ledil Oy C13233\_HB-2x2-M\_(3535\_Ceramic\_gen2) Efficiency=91%  
Lamps: 1 x LG 3535 Ceramic gen2 (PKG5700K) 461lm @ 250mA CCT=6600K P=2.9W I=250mA

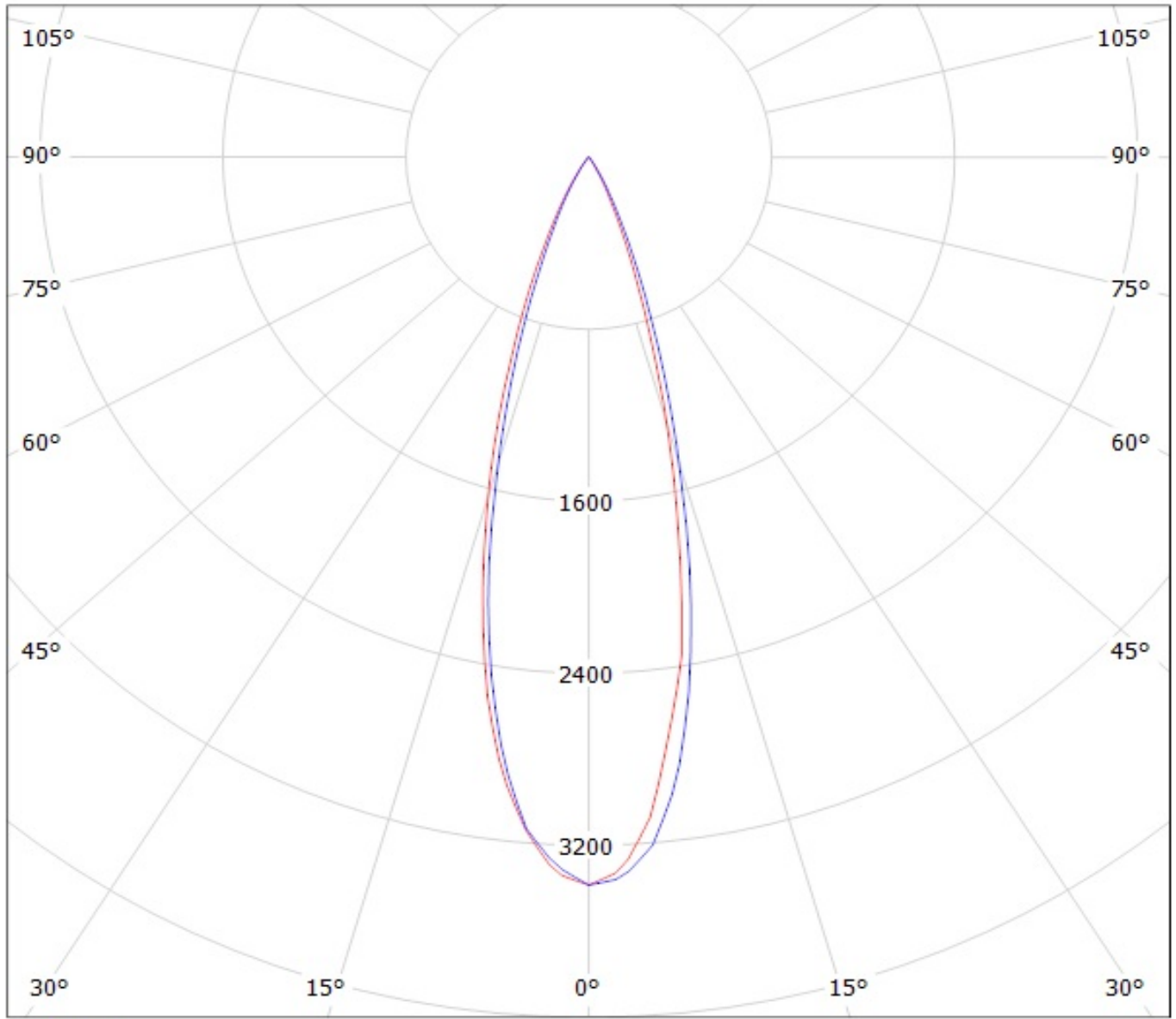

cd/klm

— C0 - C180    — C90 - C270

Luminaire: Ledil Oy C13233\_HB-2X2-M\_(Luxeon\_Z\_ES) Efficiency=91%  
Lamps: 1 x Luxeon Z ES (LXZ2-3090) 209lm @ 250mA CCT=3000K P=2.8W I=250mA

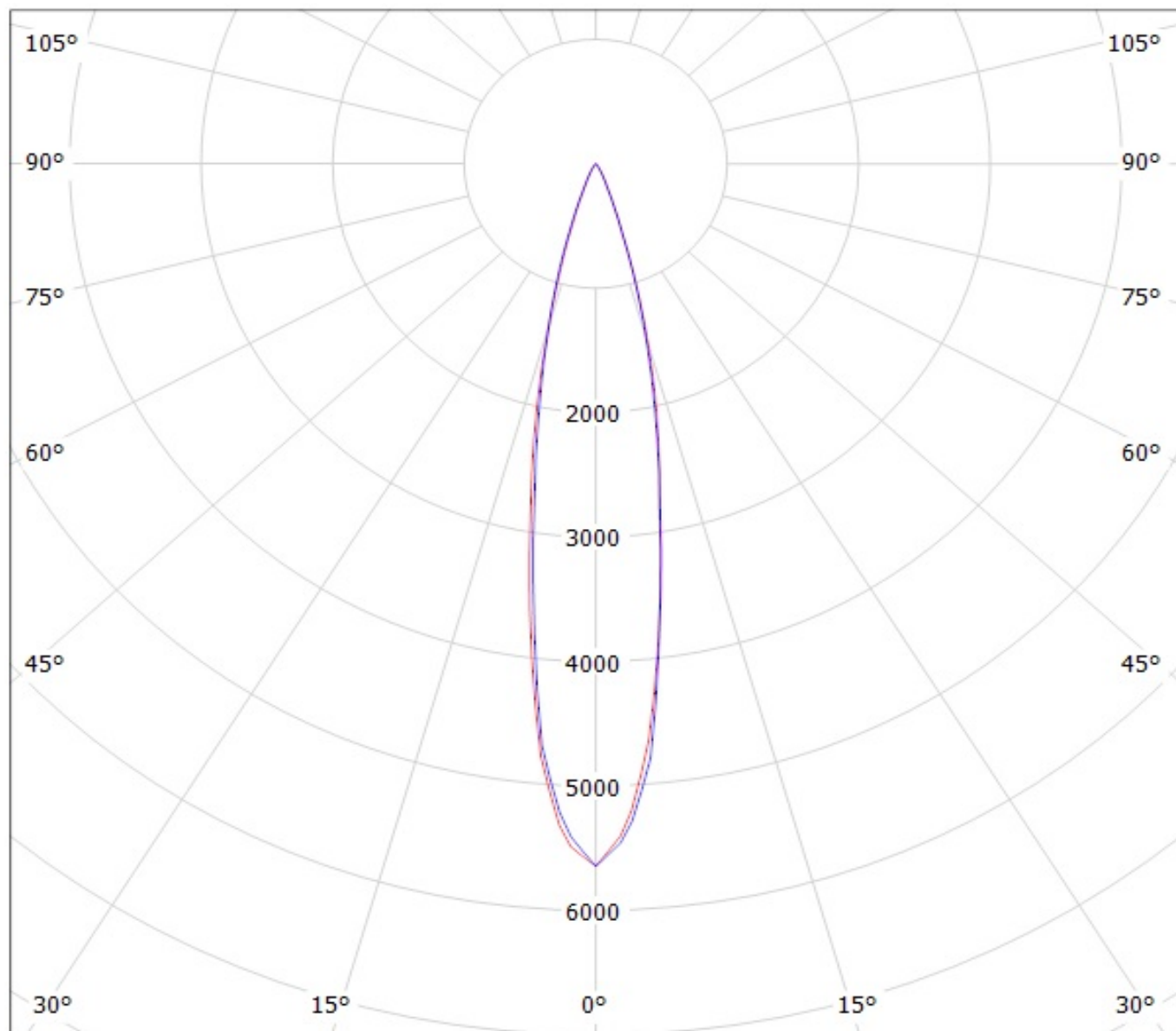

cd/klm

— C0 - C180    — C90 - C270

Luminaire: LEDiL Oy C13233\_HB-2X2-M\_(LUXEON\_Q)

Lamps: 1 x LUXEON\_Q\_2x2\_(LHQ-3080)\_298.363lm@250mA\_P=2.87385W\_I=249.9mA

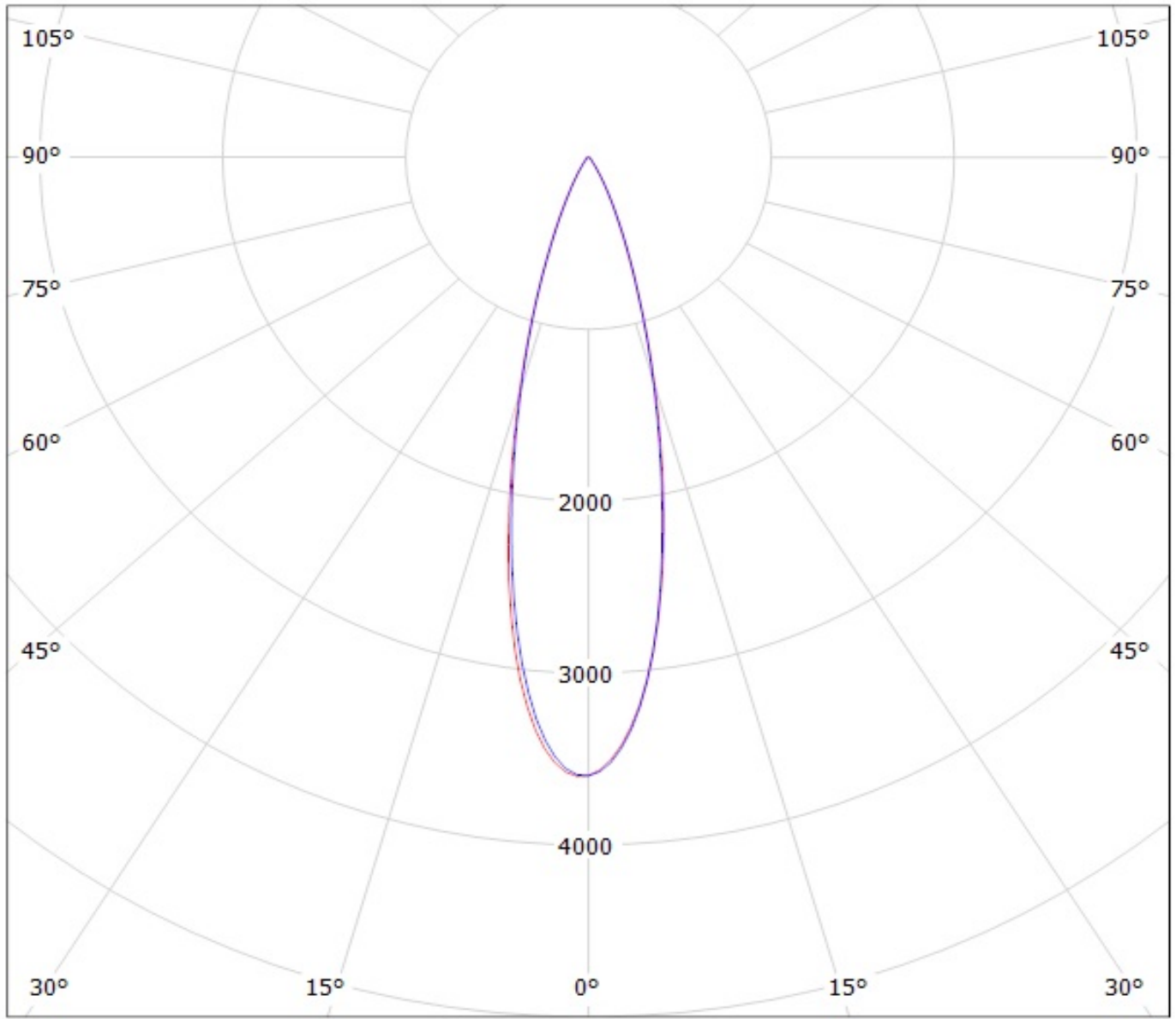

cd/klm

— C0 - C180

— C90 - C270

Luminaire: Ledil Oy C13233\_HB-2X2-M\_(Luxeon\_3030\_2D)\_SIMULATED

Lamps: 1 x Lumileds Luxeon 3030 2D

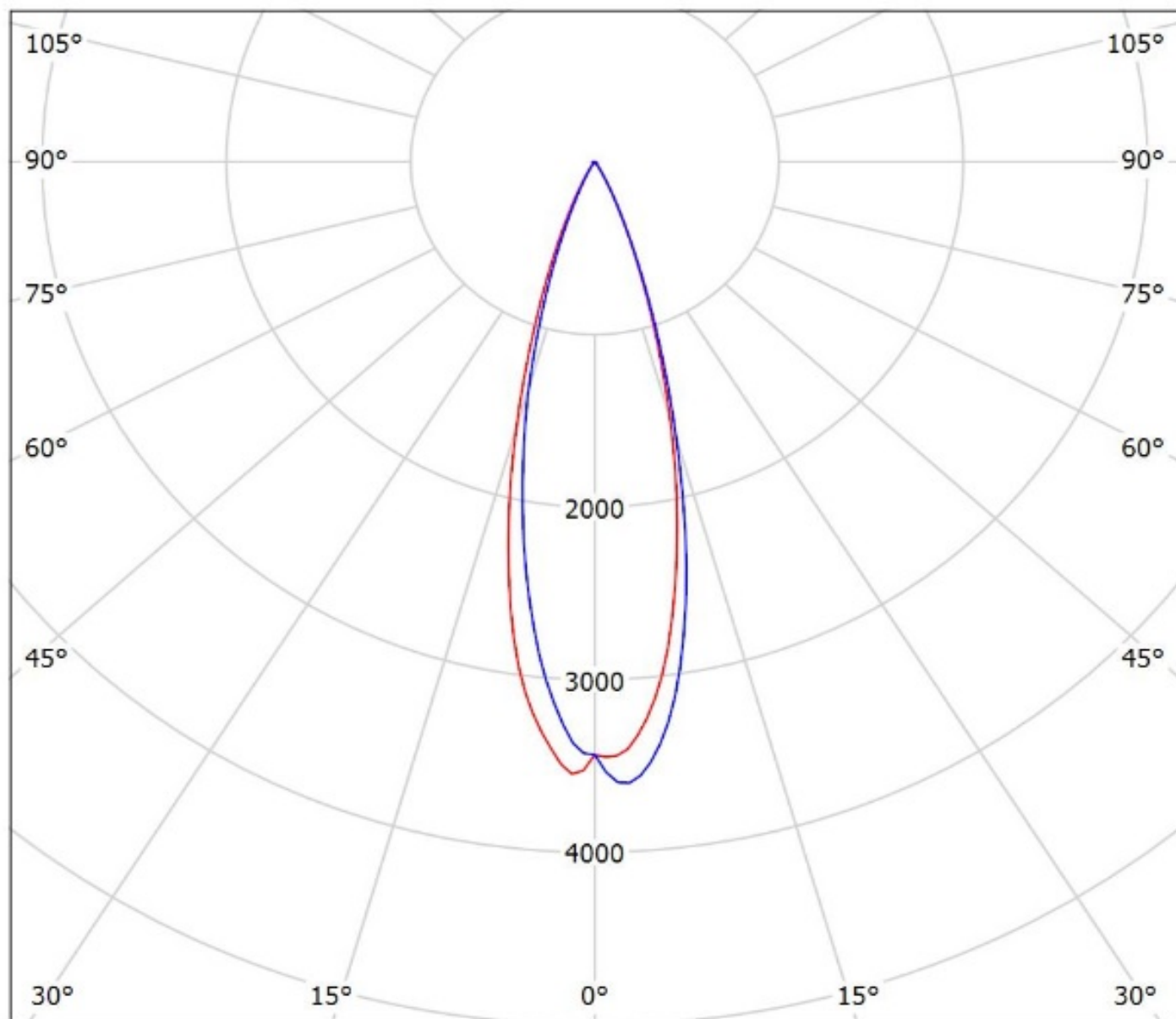

cd/klm

— C0 - C180 — C90 - C270

$\eta = 95\%$

Luminaire: Ledil Oy C13233\_HB-2x2-M (Nichia 219B 306lm @ 250mA) Efficiency=91%  
Lamps: 1 x Nichia 219B 306lm @ 250mA

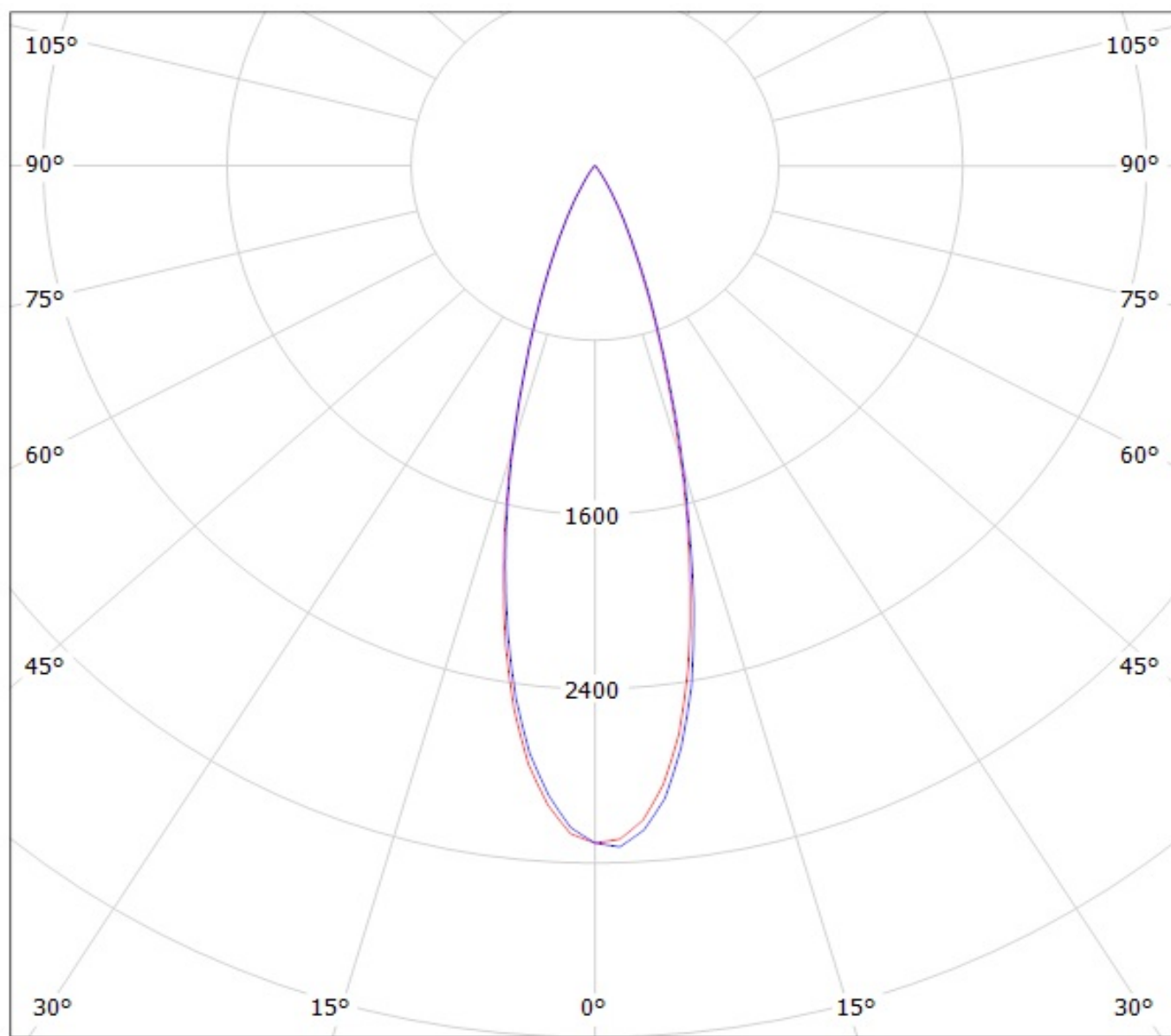

cd/klm

— C0 - C180

— C90 - C270

Luminaire: Ledil C13233-HB\_2x2-M\_(NVSL219CE)

Lamps: 1 x Nichia\_NVSL219CE\_496.405lm@250mA\_CCT=4000K\_P=2.8465W\_I=0.25A

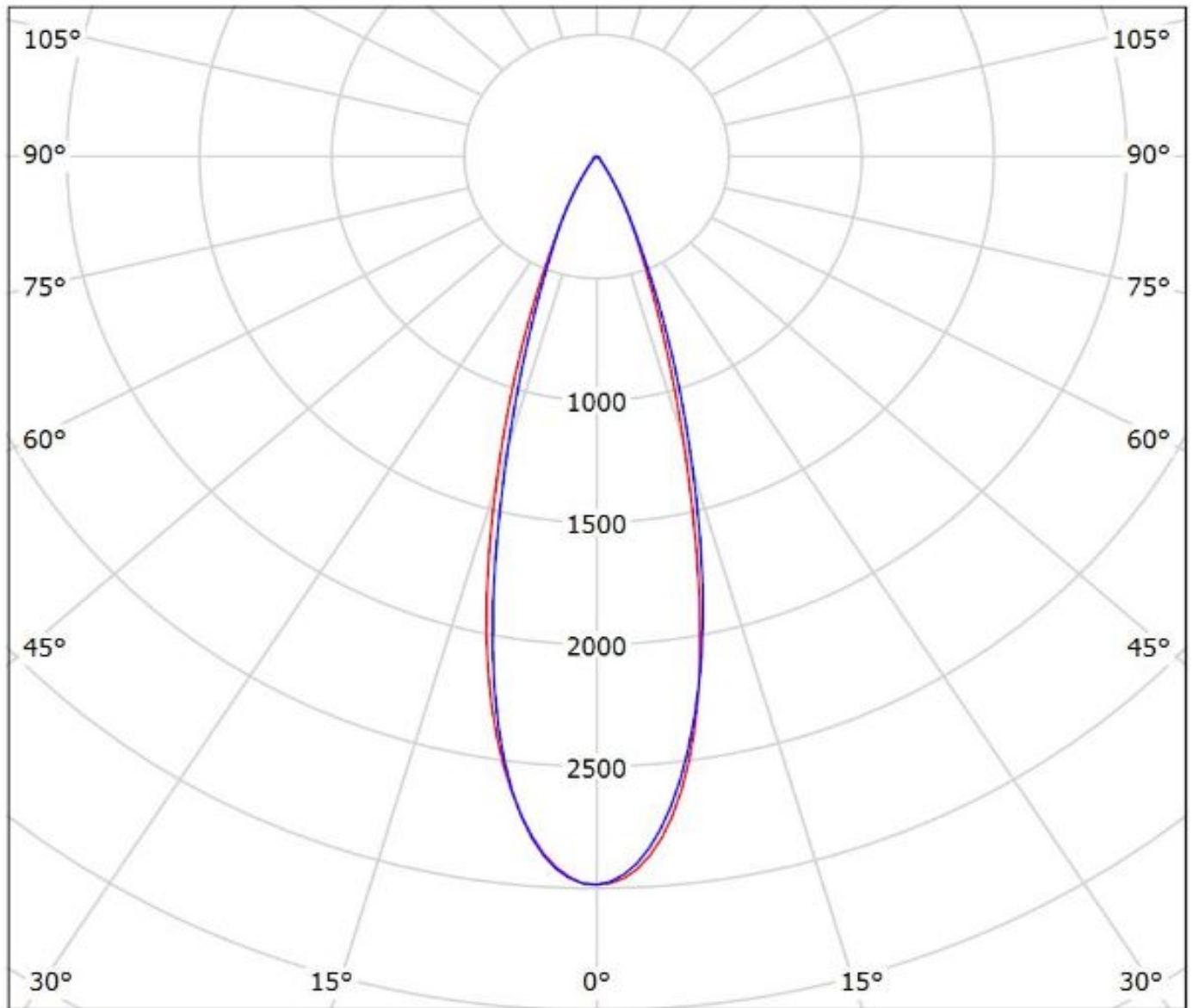

cd/klm

— C0 - C180

— C90 - C270

$\eta = 90\%$

Luminaire: LEDiL Oy C13233\_HB-2X2-M\_(E21A) Nichia\_E21A\_452.248lm@250mA\_2.805W\_I=0.250A  
Lamps: 1 x Nichia\_E21A\_452.248lm@250mA\_2.805W\_I=0.250A

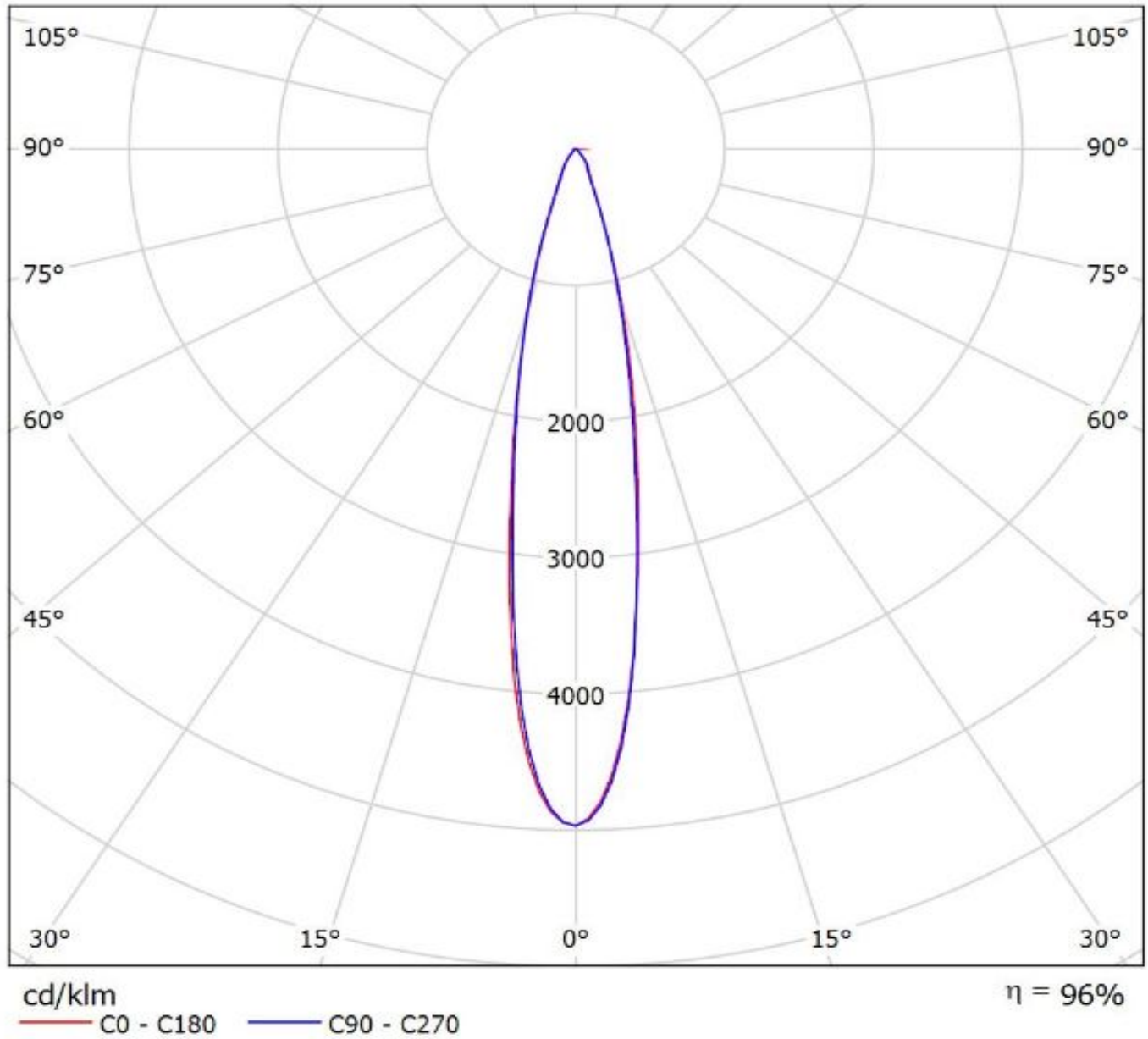

Luminaire: Ledil Oy (Osram Square PC 398lm @ 250mA) Efficiency=91%  
Lamps: 1 x Osram Square PC 398lm @ 250mA

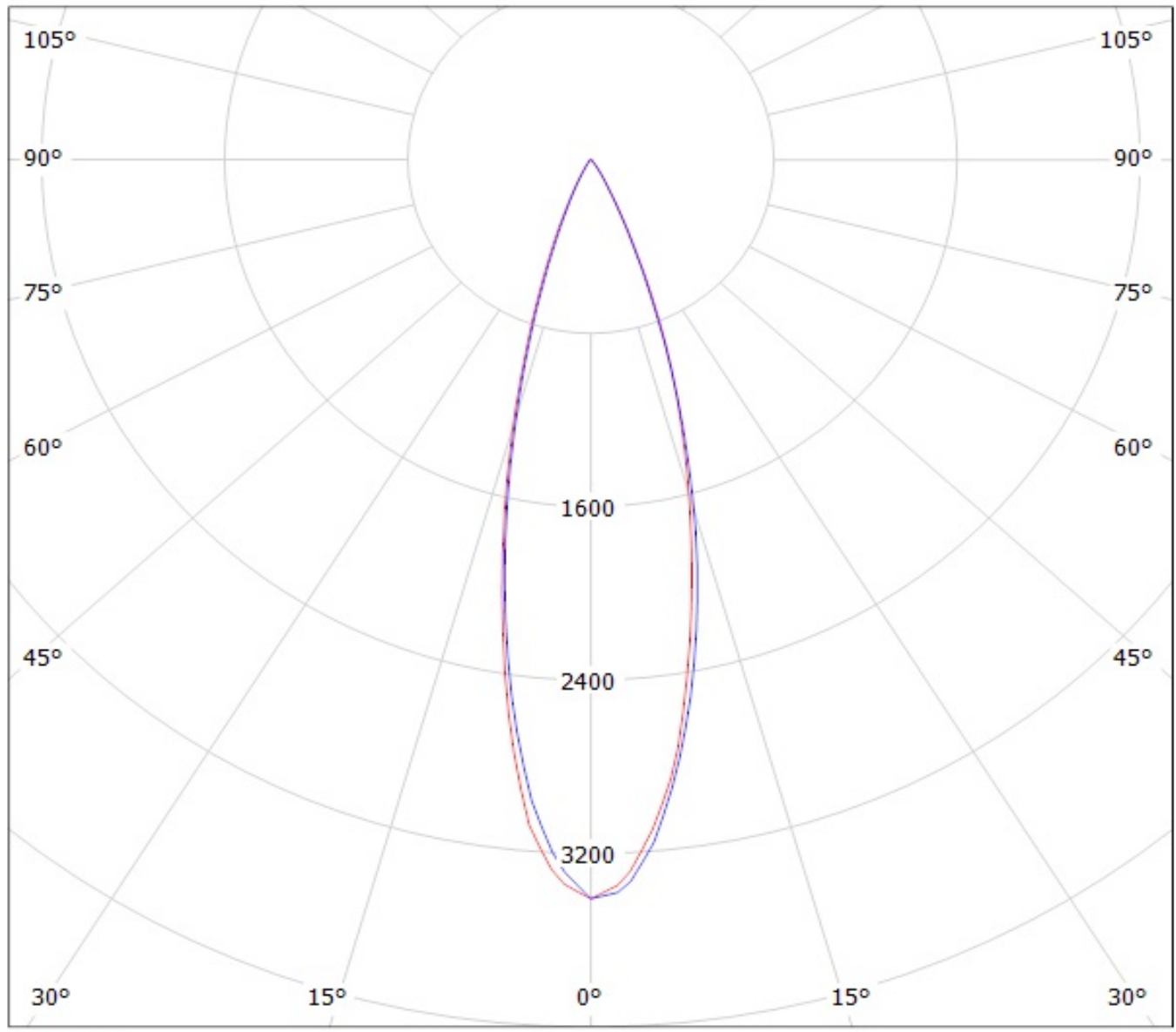

cd/klm  
— C0 - C180 — C90 - C270

Luminaire: LEDiL Oy  
Lamps: 1 x C13233-HB-2x2-M\_(SQ\_Gen3)

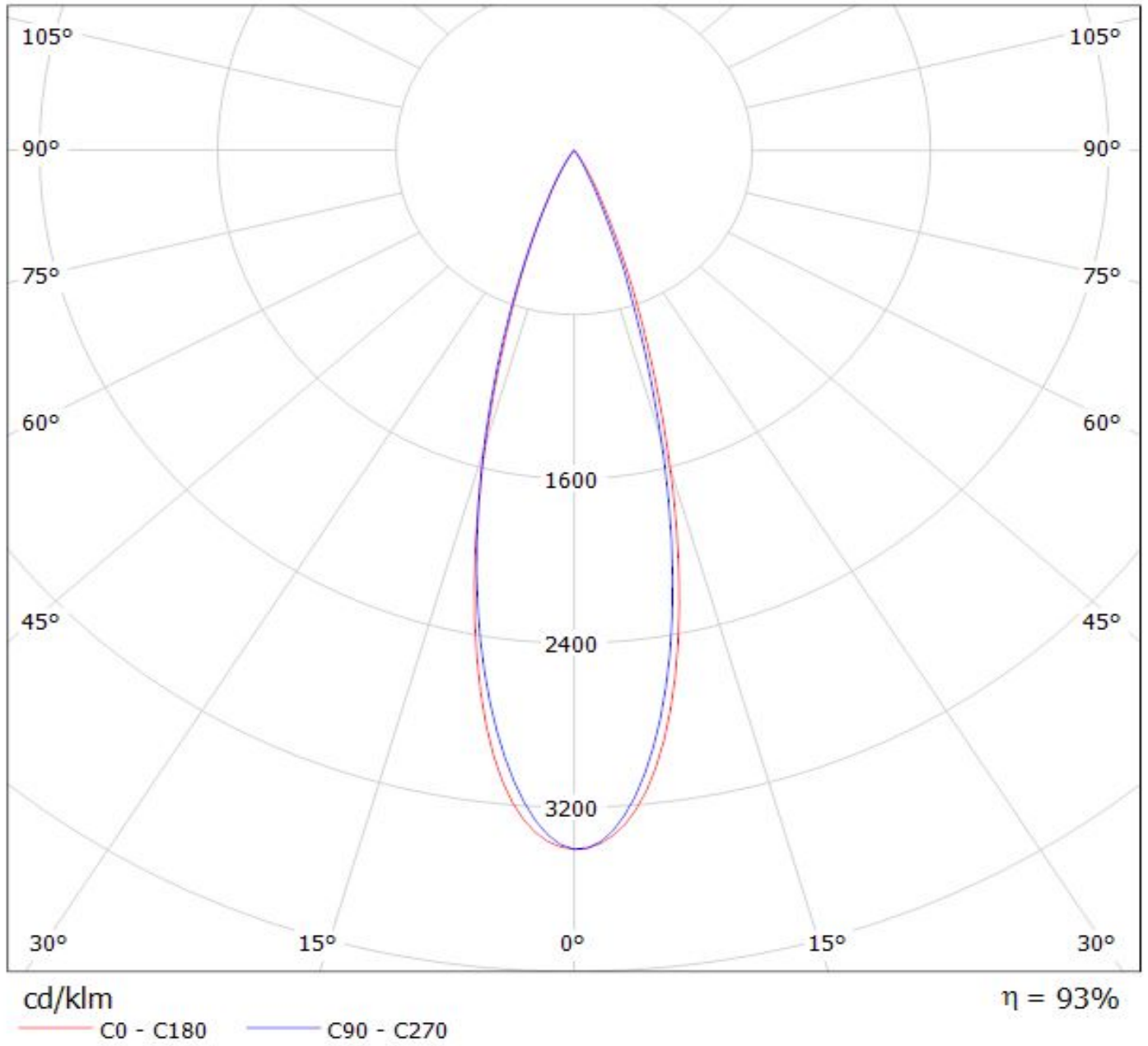

Luminaire: LEDiL Oy C13233\_HB-2X2-M\_(LH351Z) Eff.93.0%

Lamps: 1 x SAMSUNG\_LH351Z\_2x2\_359.49lm@250mA\_P=2.86371W\_I=249.8mA

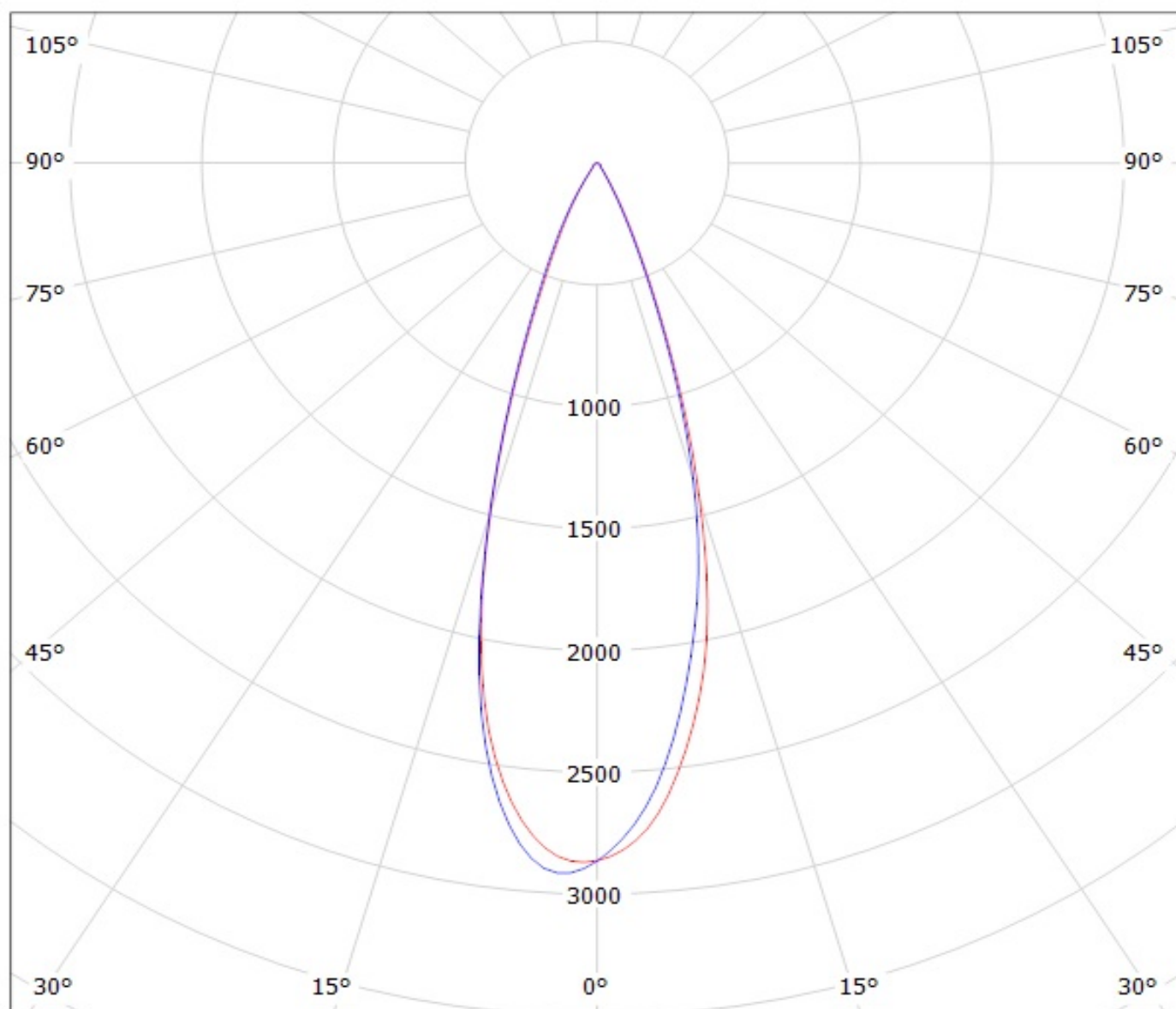

cd/klm

— C0 - C180

— C90 - C270

Luminaire: LEDiL Oy C13233\_HB-2X2-M\_(LH351B) Eff.93.6%

Lamps: 1 x SAMSUNG\_LH351B\_2x2\_430.715lm@250mA\_P=2.84311W\_I=249.9mA

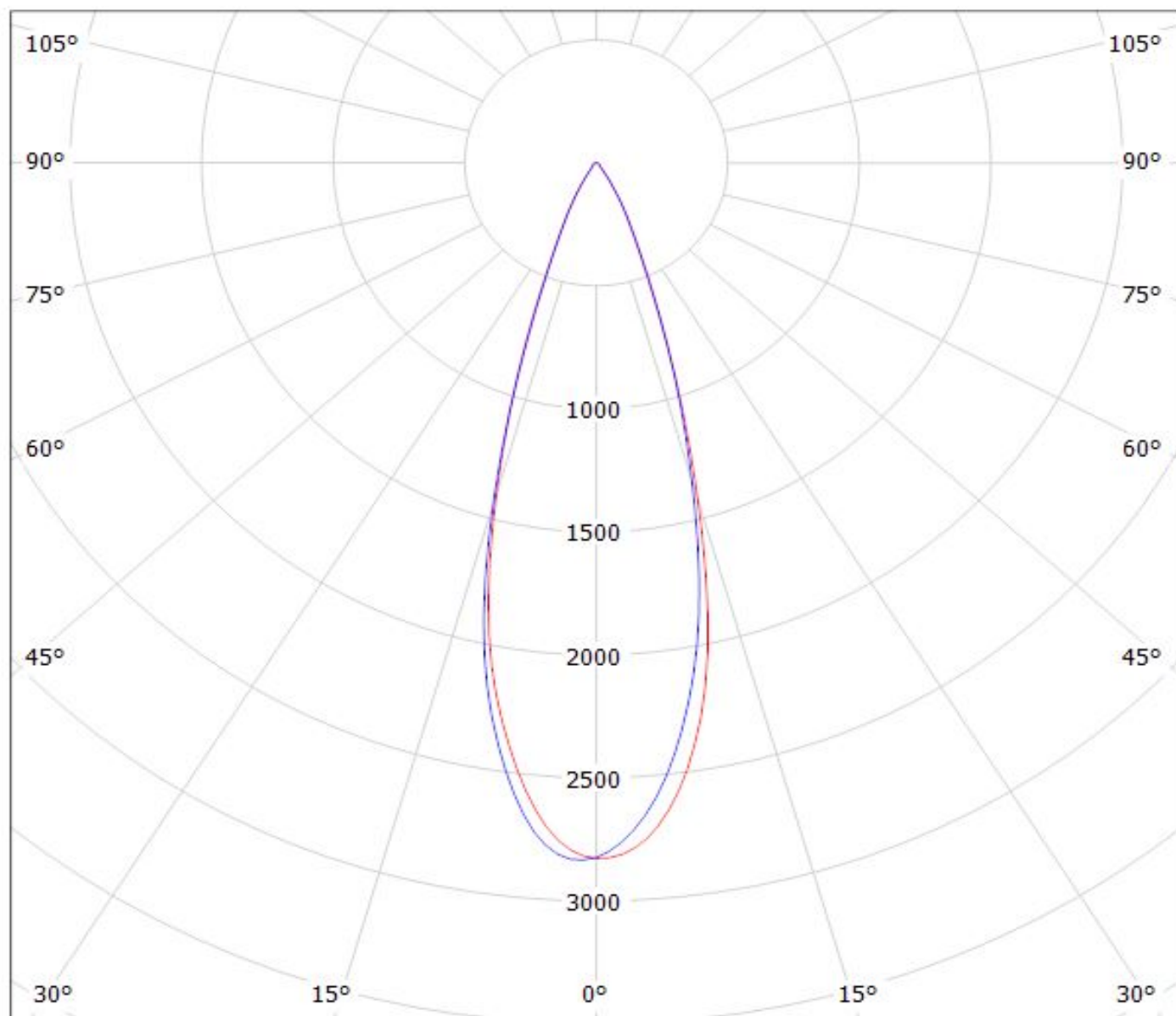

cd/klm

— C0 - C180

— C90 - C270

$\eta = 94\%$

Luminaire: LEDiL Oy C13233\_HB-2X2-M\_(WICOP2\_Z8Y15)

Lamps: 1 x SEOUL\_WICOP2\_Z8Y15\_336.842lm@250mA\_P=2.9399W\_I=0.250A

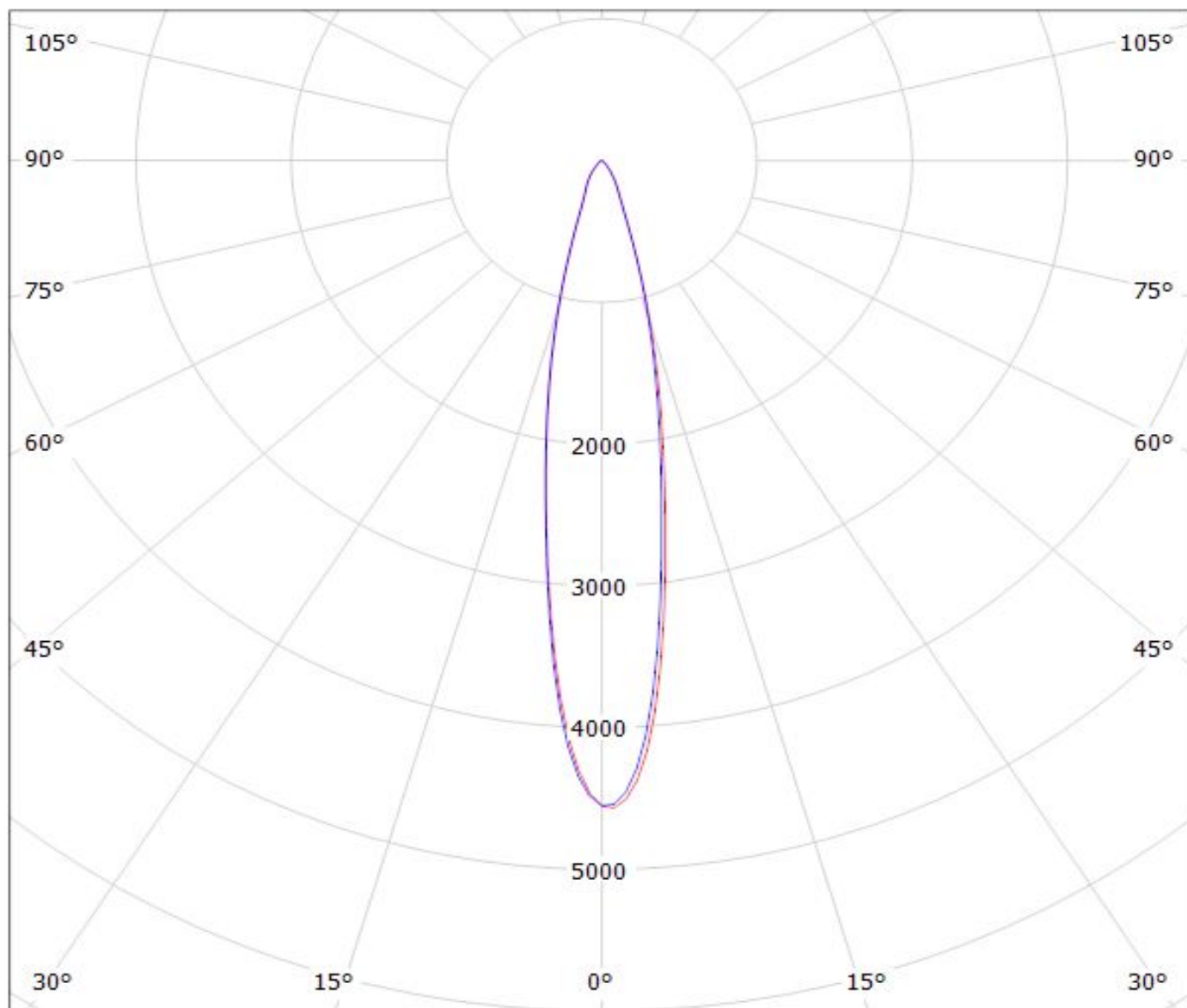

cd/klm

— C0 - C180

— C90 - C270

$\eta = 88\%$

Luminaire: LEDiL Oy C13233\_HB-2X2-M\_(WICOP2\_Z8Y19)

Lamps: 1 x SEOUL\_WICOP2\_Z8Y19\_450.124lm@250mA\_P=2.8579W\_I=0.250A

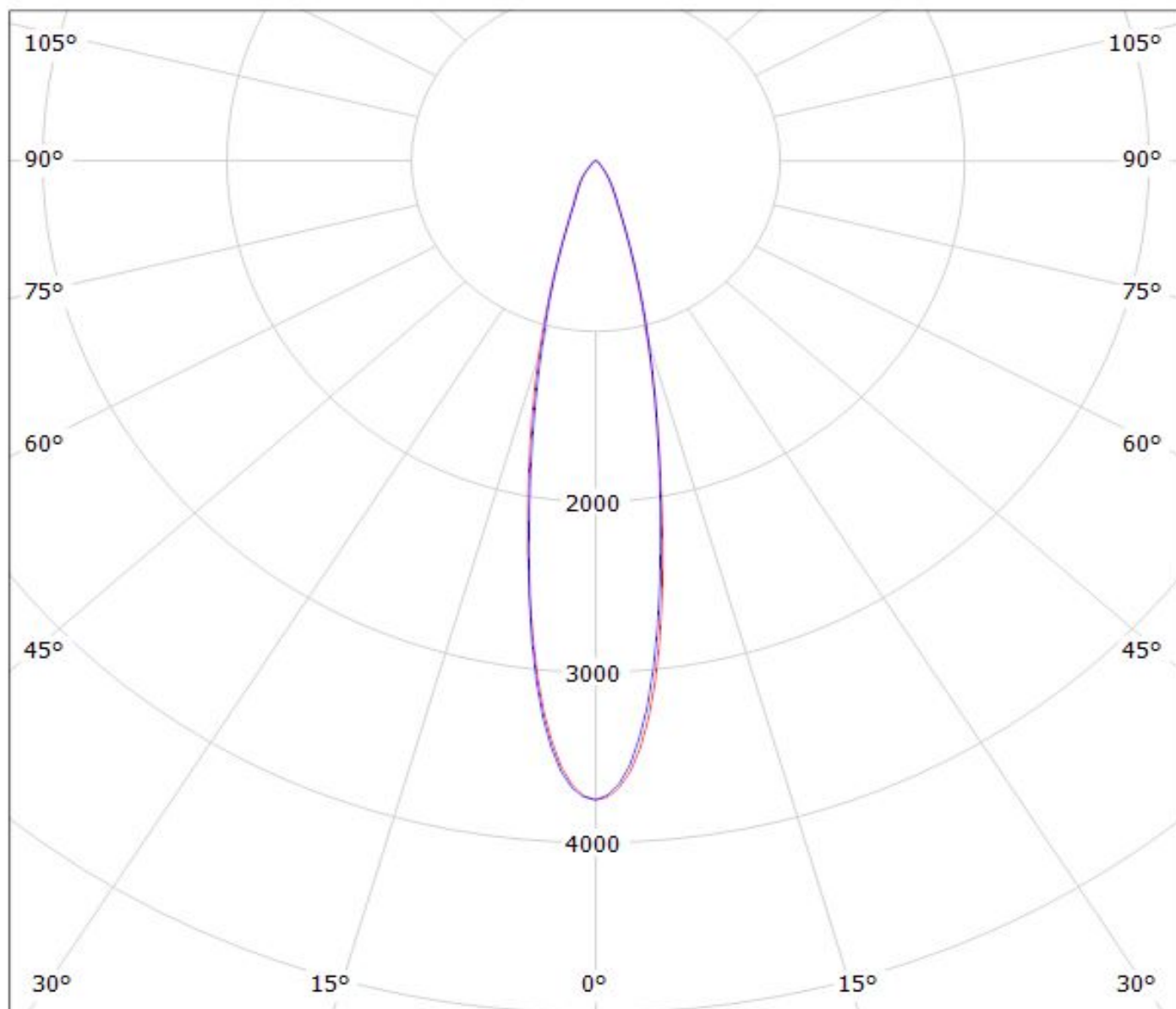

cd/klm

— C0 - C180

— C90 - C270

$\eta = 89\%$

# Ledil C13233\_HB-2X2-M\_(TL1L4) / LDC (Polar)

Luminaire: Ledil C13233\_HB-2X2-M\_(TL1L4)

Lamps: 1 x Toshiba\_TL1L4\_2x2\_(TL1L4-DW0)\_472.639lm@250mA\_CCT=6500K\_P=2.9W\_I=0.25A

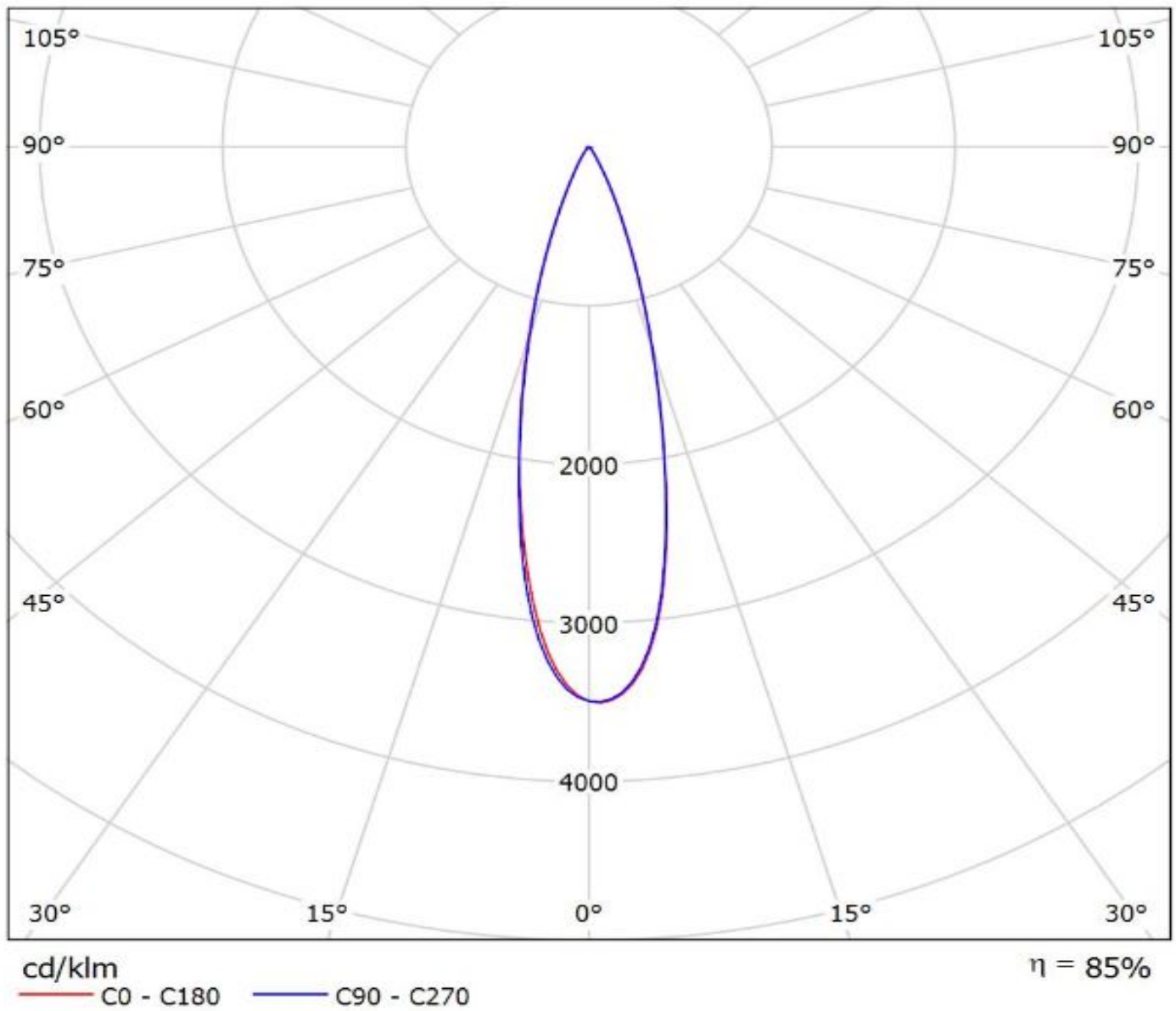

Luminaire: LEDiL Oy C13233\_HB-2X2-M (Tridonic Module\_RLE\_G1)  
Lamps: 1 x Tridonic Module\_RLE\_G1\_4576.03lm@700mA\_P=32.0681W\_η=0.700A

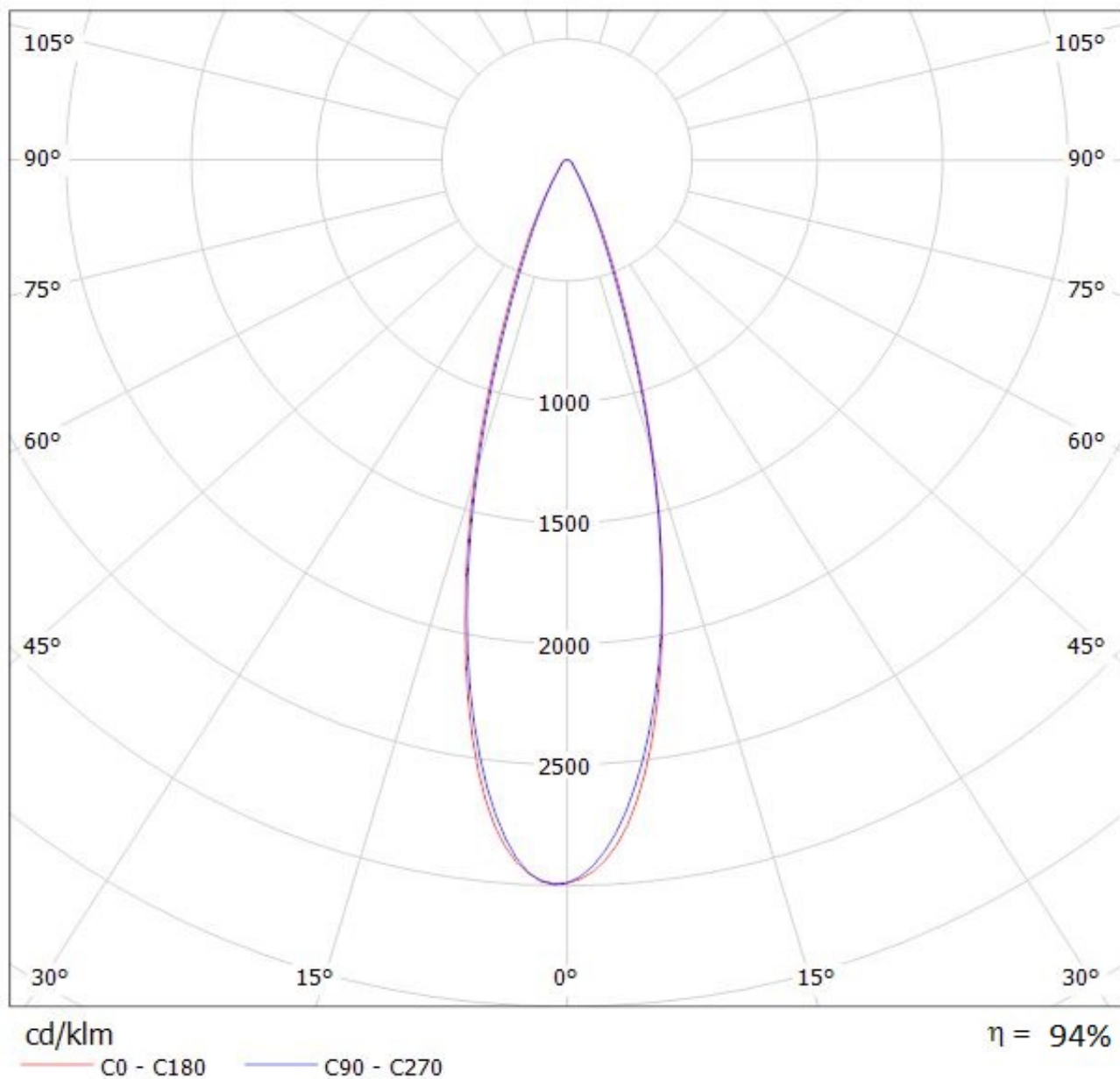

Luminaire: LEDiL Oy C13233\_HB-2X2-M (Tridonic Module\_RLE\_G1)  
Lamps: 1 x Tridonic Module\_RLE\_G1\_4576.03lm@700mA\_P=32.0681W\_η=0.700A

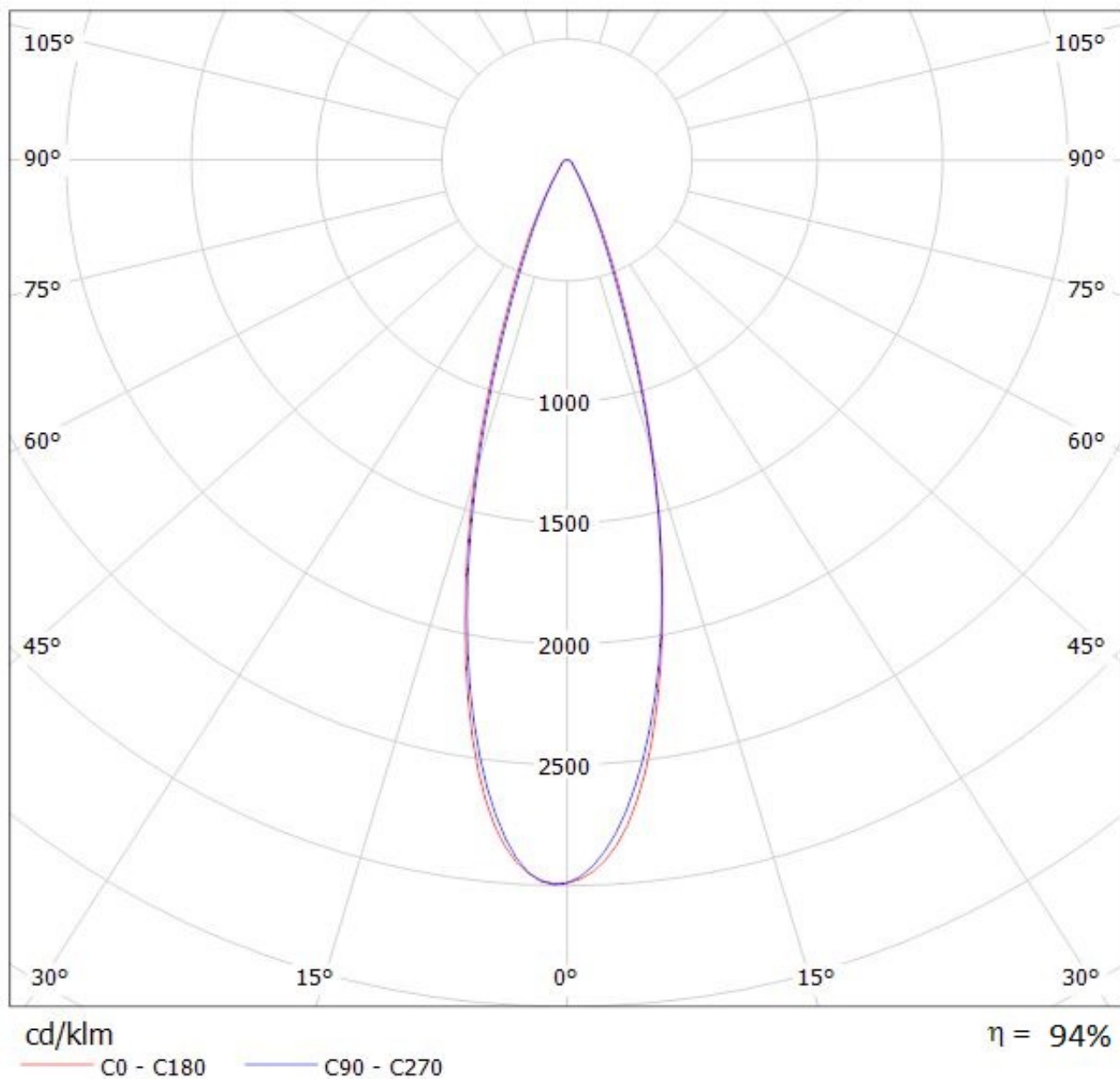

Luminaire: LEDiL Oy C13233\_HB-2X2-M\_(Tridonic\_Module\_RLE\_G1)  
Lamps: 1 x Tridonic\_Module\_RLE\_G1\_2288lm@700mA\_P=16W\_I=0.700A

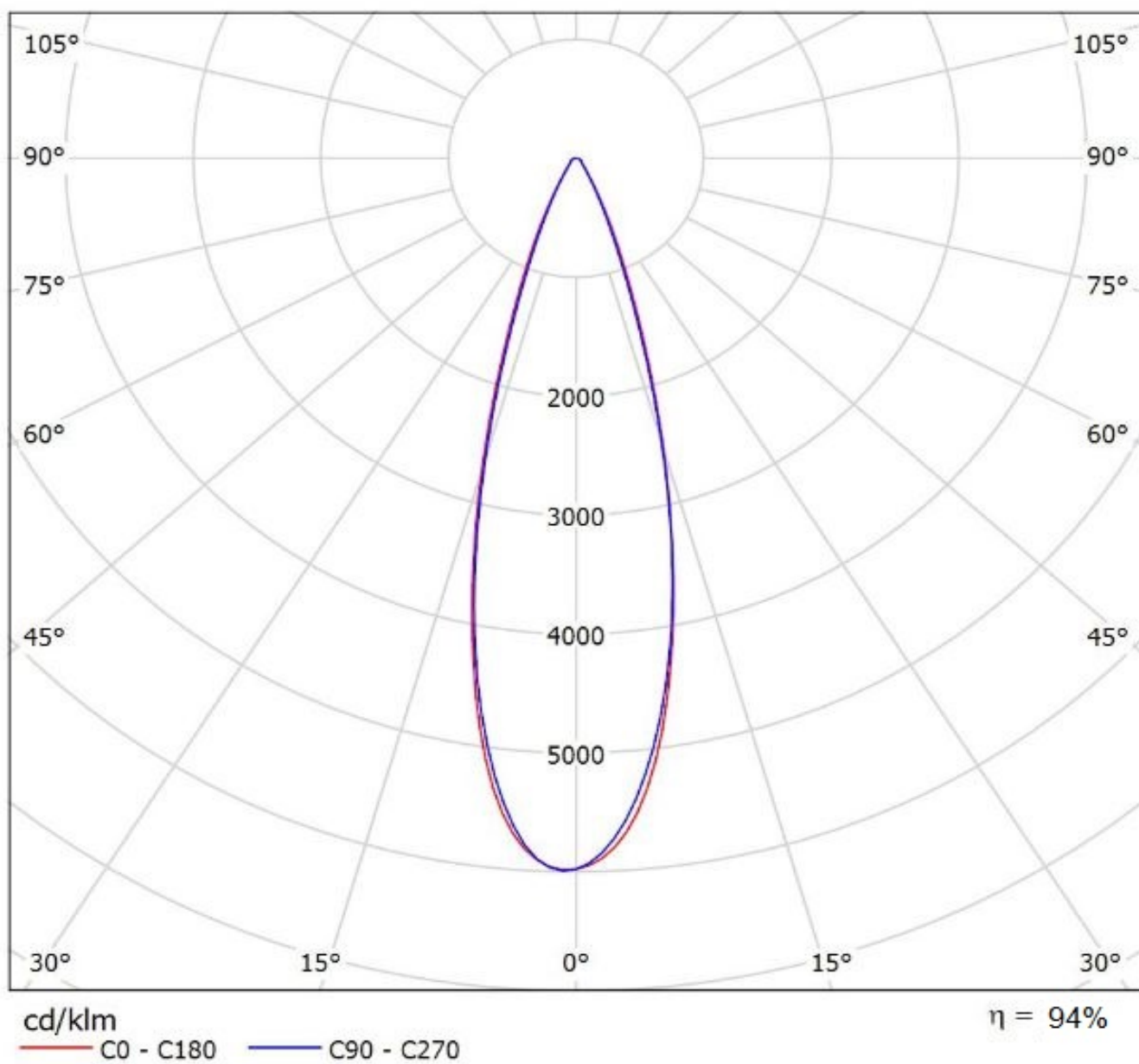

Luminaire: LEDiL Oy C13233\_HB-2X2-M\_(Tridonic\_Module\_RLE\_G1)  
Lamps: 1 x Tridonic\_Module\_RLE\_G1\_2288lm@700mA\_P=16W\_I=0.700A

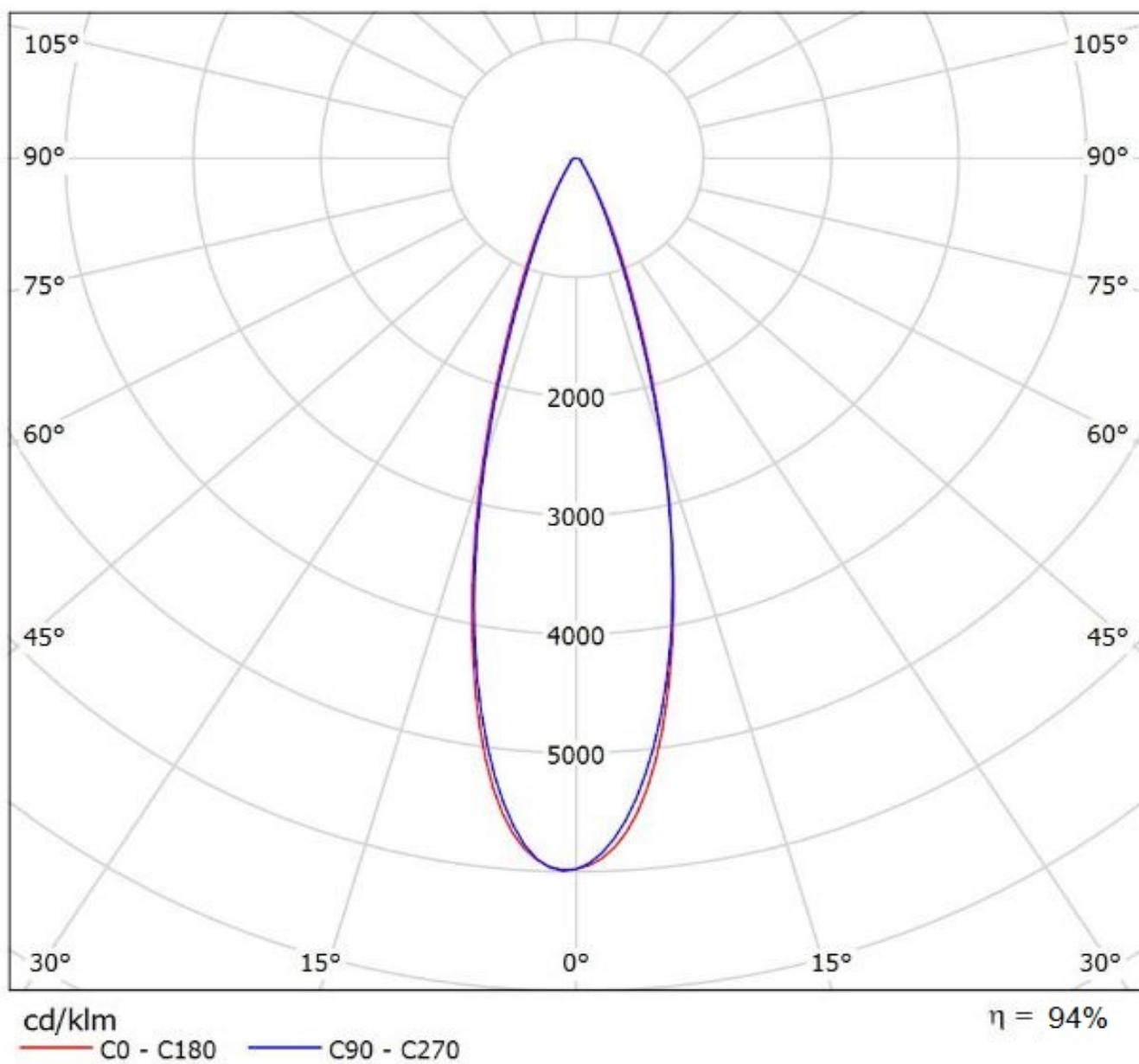

**NOTE: The typical divergence will be changed by different color, chip size and chip position tolerance. The typical total divergence is the full angle measured where the luminous intensity is half of the peak value.**