

Circuit Breaker for Equipment thermal, THT terminals for PCB mounting horizontal, 1 pole

new



Description

- Thermal circuit breaker
- 1-pole
- On request available with elevated glow-wire ratings
- THT connectors

Unique Selling Proposition

- Reset type
- Cycling trip-free release
- Compact design
- Different mounting possibilities

Standards

- IEC 60934
- UL 1077
- CSA C22.2 No. 235
- GB 17701

Applications

- Designed for standard and medical applications
- Power supplies
- Uninterruptible power supply
- Power tools
- Industrial appliances
- HVAC
- Household appliances

Weblinks

[pdf-datasheet](#), [html-datasheet](#), [General Product Information](#), [Approvals](#), [CE declaration of conformity](#), [RoHS](#), [CHINA-RoHS](#), [REACH](#), [Distributor-Stock-Check](#), [Detailed request for product](#), [Product News](#), [Video](#)

Technical Data

Rated Voltage AC	240 V, 50 / 60 Hz
Rated Voltage DC	48 / 32 V, see approvals
Rated current	3-15 A, see approbations
Conditional short circuit capacity	IEC: Inc, PC1, AC 240 V: 2 kA UL / CSA: SC, AC 240 V DC 48 / 32 V: 2 kA, C1
Degree of protection front side	IP 40
Endurance minimum	IEC: 200% I _r , cos φ 0.6: min. 50 switching cycles
Endurance typical	3-8 A: 150% I _r , cos φ 0.9: 2500 switching cycles 10-15 A: 150% I _r , cos φ 0.9: 6000 switching cycles
Dielectric Strength	1500 VAC
Insulation resistance	500 VDC > 1000 MΩ

Ambient temperature	3 A: -5 °C to 60 °C 4 A: -5°C to 50 °C 5-15 A: -5 °C to 60 °C
Soldering Methods	Wave
Solderability	245 °C / 3 sec acc. to IEC 60068-2-20 / Test Ta, method 1
Resistance to Soldering Heat	260 °C / 10 sec acc. to IEC 60068-2-20 / Test Tb, method 1A
Weight	approx. 12.5 g

Dimension

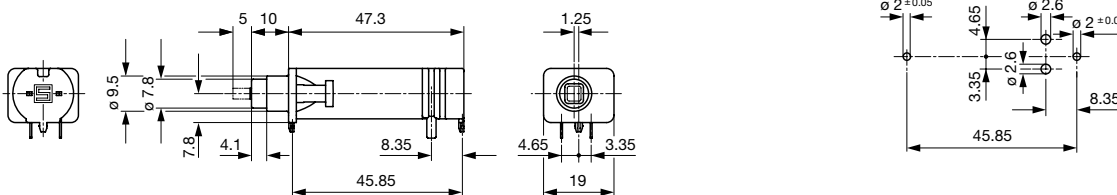



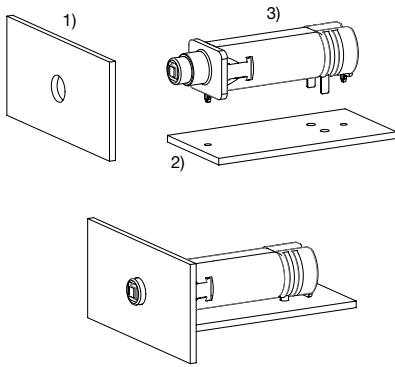

Drilling diagram

Assembly Instructions



- 1) Front panel
- 2) PCB
- 3) T9-818

Approval		Rated current	Rated voltage AC	Rated voltage DC
	UL 1077	3 - 12 A 14 - 15 A	240 V 240 V	48 V 32 V
	CSA 22.2 235	3 - 12 A 14 - 15 A	240 V 240 V	48 V 32 V
	IEC 60934	3 - 12 A 14 - 15 A	240 V 240 V	48 V 32 V
	GB 17701	3 - 12 A 14 - 15 A	240 V 240 V	48 V 32 V

Typical internal resistance

Rated Current [A]	Internal Resistance [mΩ]
3	80.0
4	26.3
5	24.1
6	19.0
7	18.0
8	14.8
10	13.0
12	12.7
14	9.7
15	8.0

Time-Current-Curves

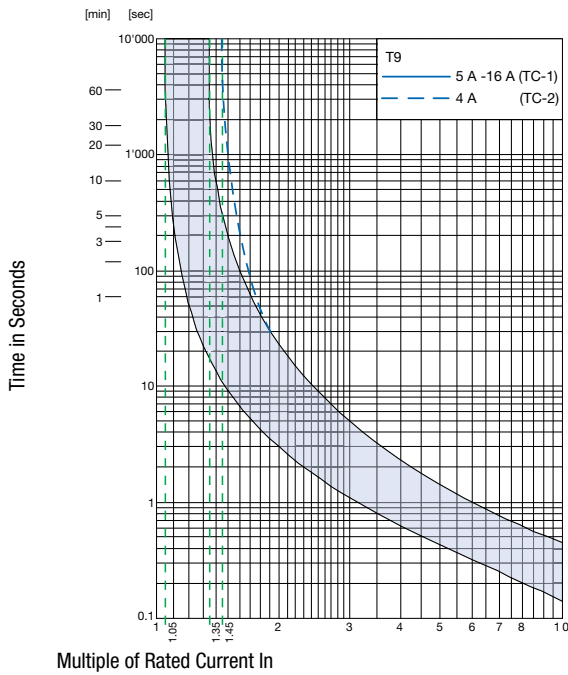

Multiple of Rated Current In

Reference Temperature +23°

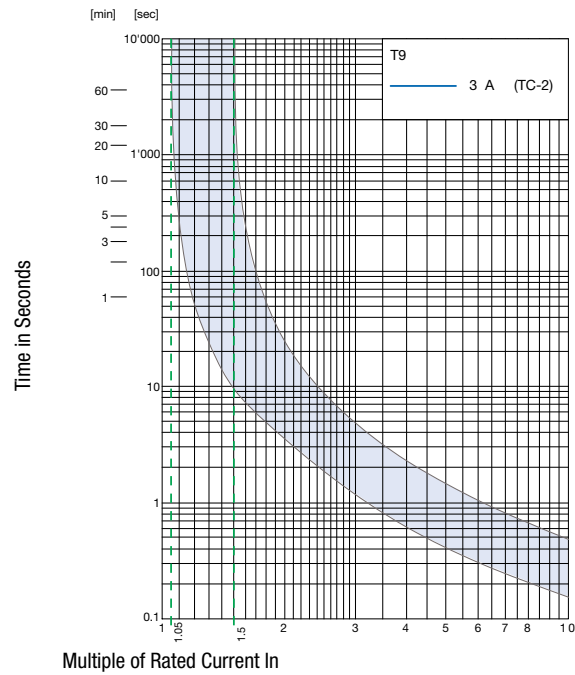

Multiple of Rated Current In

Reference Temperature +23°

Effect of ambient temperature

The units are calibrated for an ambient temperature of +23°C. To determine the rated current for a lower or higher ambient temperature, use a correction factor (typical value) from the table below:

Ambient temperature [°C]	Correction factor
-5	0,85
+10	0,95
+23	1,00
+40	1,08
+60	1,21

Example: Rated current = 10 A; Environmental temperature = 60 °C; --> Correction factor = 1.21; Resulting current = 12.1 A --> Fount to next higher rated current: 13 A

Variants

connection type	Rated current	Order Number
Solder, THT	3A	4404.0096
Solder, THT	4A	4404.0097
Solder, THT	5A	4404.0098
Solder, THT	6A	4404.0099
Solder, THT	7A	4404.0100
Solder, THT	8A	4404.0101
Solder, THT	10A	4404.0102
Solder, THT	12A	4404.0103
Solder, THT	14A	4404.0104
Solder, THT	15A	4404.0105

Most Popular.

Availability for all products can be searched real-time:<http://www.schurter.com/Stock-Check/Stock-Check-SCHURTER>

Packaging Unit 100 Pcs

The specifications, descriptions and illustrations indicated in this document are based on current information. All content is subject to modifications and amendments. Information furnished is believed to be accurate and reliable. However, users should independently evaluate the suitability and test each product selected for their own applications.