

## General Description

The MAX38801 evaluation kit (EV kit) serves as a reference platform for evaluating the MAX38801 voltage regulator IC. This single-chip, integrated switching regulator provides an extremely compact, highly efficient, fast, accurate, and reliable power delivery solution for low-output voltage applications. The MAX38801 has different programmability options to enable a wide range of configurations.

The EV kit consists of a fully-assembled and tested Printed Circuit Board (PCB) implementation of the MAX38801. Jumpers, test points and input/output connectors are included for flexibility and ease-of-use. Refer to the data sheet for ordering information and more details.

## Applications

- Servers/ $\mu$ Servers
- I/O and Chipset Supplies
- GPU Core Supply
- DDR Memory—VDDQ and VTT
- Point-of-Load (PoL) Applications

Ordering Information appears at end of data sheet.

## Features

- High-Efficiency Solution
  - Up to 96% Peak
  - Up to 92% Full-Load
  - Up to 94% Light-Load Efficiency at 1A with DCM Enabled
- Inductor Valley Current Limit is Configured to 12A ( $R\_SEL = R1 = 46.4k\Omega$ )
- Programmable Switching Frequency from 400kHz to 900kHz
- Programmable Positive and Negative OCP Limit
- Programmable Reference Voltage with External Input Option
- Fast Transient Response with Quick PWM™ Architecture
- Differential Remote Sense with Open-Circuit Detection
- Percentage-Based Output Power Good and OVP
- Open-Drain Status Indicator (STAT) Pin
- Input Undervoltage and Overvoltage Lockout
- Adaptive Dead Time Control
- Integrated Boost Switch
- 19-Bump WLCSP (2.2mm x 2.8mm) Footprint
- Operation Using Ceramic Input and Output Capacitors

Quick PWM is a trademark of Maxim Integrated Products, Inc.

## Quick Start

### Required Equipment

- MAX38801 EV kit
- 12V, 10A DC power supply
- Load capable of sinking 12A
- Digital voltmeter
- Oscilloscope

### Procedure

The EV kit is fully assembled and tested. Follow the steps below to verify the board operation. **Caution: Do not turn on power supply until all connections are completed.**

- 1) Connect a 12V power supply to the VDD1 and GND1 banana jacks.
- 2) Make sure the shunt is installed on:
  - a) J16 (1-2) to close the sense line.
  - b) J4 (1-2) to power up the on-board LDO which regulates 1.8V.
  - c) J12 (1-2) to provide the 1.8V bias supply to the regulator from the on-board LDO.
  - d) J15 (3-5) to pull up the STAT pin.
  - e) J15 (4-6) to pull up the OE pin.
- 3) Connect a voltmeter to the VOUT and GND banana jacks (J8, J11, J13, and J14 can be used as well).
- 4) Turn on the power supply.
- 5) Verify that the voltmeter reads 1.05V.

## Detailed Description of Hardware

The MAX38801 provides compact high-efficiency power delivery for precision outputs that demand fast transient response. The 19-ball (2.2mm x 2.8mm) CSP package minimizes the PCB area. The EV kit is preset for 1.05V output and can provide up to 12A from a 6.5V to 14V input supply.

### Bias Supply

The MAX38801 EV kit has an on-board LDO (U2) that can provide the required 1.8V VCC bias voltage to the regulator as well as the pull up voltage for the Output Enable (OE) input. This allows testing the part using a single external power supply.

To enable the on-board LDO install the shunt on jumper J4. To effectively use the LDO to supply the VCC bias voltage to the regulator also install the shunt on jumper J12.

In order to properly measure the efficiency of the regulator, the LDO should not be active. To disable it, both the shunts on J4 and J12 need to be removed. An external 1.8V, 0.1A current limited power supply needs to be

connected between J12-2 and ground. The same signal should be connected to J10 (1-2) to pull up the OE pin.

### Regulator enable

To enable the regulator, OE pin needs to be pulled high. If the on-board 1.8V LDO is active (the shunt on jumper J4 is in place), the output voltage can be used for the purpose. Installing a shunt on J15 (4-6) pulls the OE signal high to 1.8V through a 20kΩ resistor. To shut down the regulator a shunt needs to be installed on J10. This forces the OE pin low.

### Status Pin

The MAX38801 has an open collector status (STAT) output to report fault or output under voltage event. Install a shunt on J15 (3-5) to pull up this pin to V<sub>CC</sub> through a 20kΩ resistor. Since STAT pin is 3.3V tolerant, a shunt on J15 (1-3) can be installed to pull up this pin through a 20kΩ resistor to the 3.3V provided by the on board regulator U3 (install a shunt on J5 (3-4) to enable the LDO).

### Scenario Selection

Several parameters of the MAX38801 can be programmed to allow optimization for specific applications. By selecting the appropriate value of resistor R\_SEL (R1) and capacitor C\_SEL (C4), the optimum set of parameters (scenario) can be programmed.

While R\_SEL selects the proper scenario, C\_SEL determines the nominal F<sub>SW</sub>. The MAX38801 features a configuration table to provide a wide range of options. [Table 1](#) shows the scenario table for MAX38801.

### Setting the Output Voltage

The output voltage of MAX38801 depends both on the reference voltage ( $V_{REF}$ ) and the resistor divider ratio.

#### Equation 1

$$V_{OUT} = V_{REF} \times \left( 1 + \frac{R_6}{R_9} \right)$$

The reference voltage is selected through RSEL (see [Table 1](#)) and can be either internal or external (refer to the data sheet for more details). In order to optimize the common mode rejection of the error amplifier, choose the voltage divider resistors so that their parallel resistance  $R_{PAR}$  is as close as possible to  $2k\Omega$ .

#### Equation 2

$$R_6 = V_{OUT} \times \left( \frac{R_{PAR}}{V_{REF}} \right)$$

$$R_9 = R_6 \times \left( \frac{R_{PAR}}{R_6 - R_{PAR}} \right)$$

where,

$R_6$  = Top divider resistor

$R_9$  = Bottom divider resistor

$R_{PAR}$  = Desired parallel resistance of  $R_6$  and  $R_9$

$V_{OUT}$  = Output voltage

$V_{REF}$  = Reference voltage

### Operation with External $V_{REF}$

When using an external reference adopt the configuration shown in [Figure 1](#). Once OE is asserted, the regulator briefly discharges the SENSE- node and releases it as regulation begins. In this case, the soft-start ramp is determined by the external low-pass filter time constant. The external filter time constant needs to be lower than  $T_{SS}/3$  in order to avoid premature assertion of STAT pin while the output voltage is still ramping.

The external reference voltage can be applied prior to enabling the regulator, or ramped up right after enable is asserted. In both cases, the low-pass filtered reference voltage at SENSE- pin must reach its final value within  $T_{SS}$ .

Typical values for the filter components are:

- $R_F = 2.2k\Omega$
- $C_F = 0.22\mu F$

**Table 1. MAX38801 Configuration Table**

R_SEL (kΩ)	V_REF (V)	SOFT-START TIME (T <sub>SS</sub> ) (ms)	VALLEY OCP INCEPTION (A)	OPERATION MODES	REPORTING (CURRENT/TEMP)	R <sub>SENSE</sub> (GAIN) (MΩ)	F <sub>SW</sub> (kHz)			T <sub>STAT</sub> (μs)
							C_SEL			
							0pF	200 pF	820 pF	
1.78	0.95	6	12	CCM	Current	2.1	700	800	900	2000
2.67			15	CCM/DCM						
4.02		3	12	CCM						
6.04			15	CCM/DCM						
9.09	Ext.	1.5	12	CCM						
13.3			18	CCM/DCM						
20.0	0.6	6	18	CCM/DCM						
30.9				CCM						
46.4			12	Temp						
71.5				CCM/DCM						
107				Current						
162	Ext.	1.5	15	CCM	Temp	2.1	400	500	600	128

**Input Voltage Monitoring**

VDD1 and GND1 sense points as well as J3 can be used to monitor the input supply.

**Output Voltage Monitoring**

J11 and J13 monitor the output voltage. These test points should not be used for loading. Use scopejack J14 to monitor the output voltage ripple on an oscilloscope.

**Efficiency Measurement**

The following steps describe how to measure the regulator efficiency.

- 1) Connect a 12V power supply to the VDD1 and GND1 banana jacks. To avoid the input voltage to drop at high load due to power losses on connection cables connect the sense lines of the power supply to VDD1 and GND1 headers.
- 2) Connect an external 1.8V, 0.1A current limited power supply between J12-2 and ground
- 3) Connect the same power supply to J10-1 to enable the regulator.

- 4) Connect a load to the VOUT and GND banana jacks for better results. J8 can also be used for low currents.
- 5) Make sure the shunt is installed on J16 (1-2) to close the sense line
- 6) Remove all the other jumpers.
- 7) Connect a voltmeter to J11 or J13.
- 8) Turn on the power supply.
- 9) Measure  $V_{IN}$ ,  $I_{IN}$ ,  $V_{OUT}$ ,  $I_{OUT}$ ,  $V_{BIAS}$ , and  $I_{BIAS}$ .
- 10) Calculate the efficiency as:

**Equation 3**

$$\eta = \left( \frac{V_{OUT} \times I_{OUT}}{(V_{IN} \times I_{IN}) + (V_{BIAS} \times I_{BIAS})} \right)$$

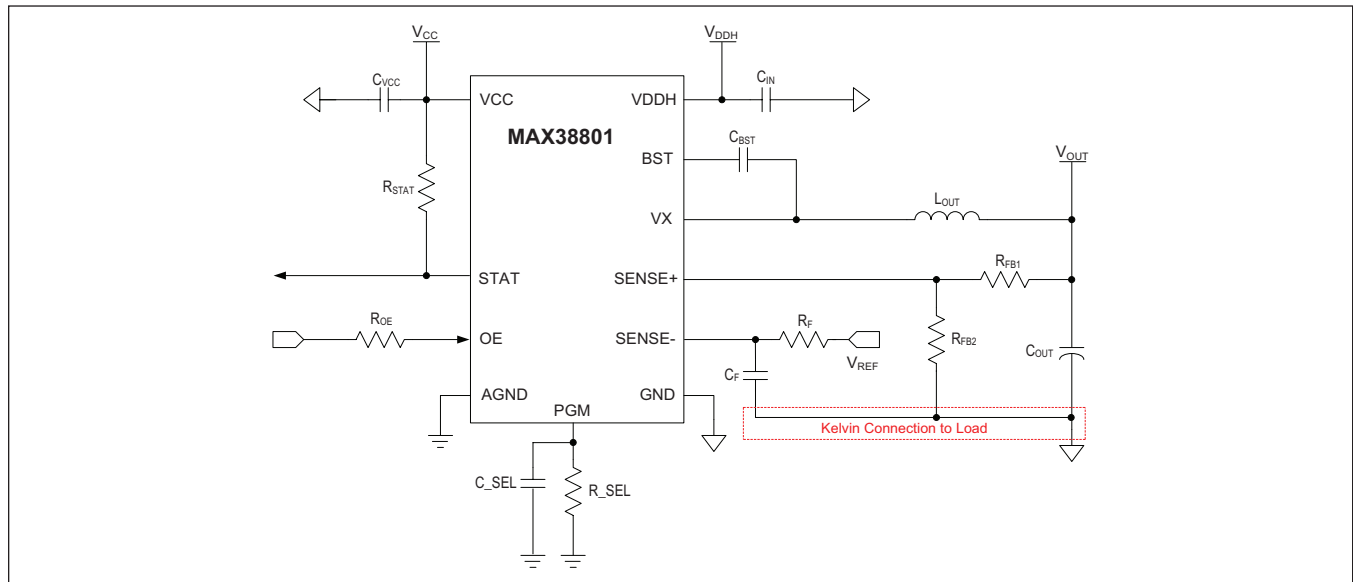

Figure 1. Electrical Connections to Use the External Voltage Reference Feature.

MAX38801 EV Kit Bill of Materials

ITEM	REF_DES	DN/DNP	QTY	MFG PART #	MANUFACTURER	VALUE	DESCRIPTION
1	C1, C2	-	2	TPSE157M016R0100	AVX	150µF	CAPACITOR: SMT; TANTALUM; 150µF; 16V; 20%; TPS; -55°C to +125°C
2	C3	-	1	C0402X7R160-104KNE; CL05B104K050NNWC; GRM155R71C104KA88; C1005X7R1C104K; CC0402KRXR7R7BB104; EMK105B7104KV	VENKEL LTD./SAMSUNG ELECTRONICS/ MURATA/TDK/YAGEO PHICOMP/ TAIYO YUDEN	0.1µF	CAPACITOR: SMT (0402); CERAMIC CHIP; 0.1µF; 16V; TOL = 10%; TG = -55°C TO +125°C; TC = X7R;
3	C4	-	1	ECJ-0E81E821K	PANASONIC	820PF	CAPACITOR: SMT (0402); CERAMIC CHIP; 820PF; 25V; TOL = 10%; MODEL = ECJ SERIES; TG = -55°C TO +125°C; TC = X7R
4	C5, C6, C10, C11	-	4	C3216X7R1C106M160AC	TDK	10µF	CAPACITOR: SMT (1206); CERAMIC CHIP; 10µF; 16V; TOL = 20%; MODEL = C SERIES; TG = -55°C TO +125°C; TC = X7R
5	C7, C21, C54	-	3	EMK107B7105MA	TAIYO YUDEN	1µF	CAPACITOR: SMT (0603); CERAMIC CHIP; 1µF; 16V; TOL = 20%; MODEL = M SERIES; TG = -55°C TO +125°C; TC = X7R
6	C8	-	1	GRM188R71E474KA12	MURATA	0.47µF	CAPACITOR: SMT (0603); CERAMIC CHIP; 0.47µF; 25V; TOL = 10%; MODEL = GRM SERIES; TG = -55°C TO +125°C; TC = X7R
7	C9, C55	-	2	JMK105BB1475MV-F; C1005X5R0J475M050BC	TAIYO YUDEN; TDK	4.7µF	CAPACITOR: SMT (0402); CERAMIC CHIP; 4.7µF; 6.3V; TOL = 20%; TG = -55°C TO +85°C; TC = X5R
8	C12, C15, C16, C20, C34, C42, C44	-	7	C0805C226MPPAC; GRM21BR60J226ME39; JMK212BJ226MG; CL21A226MOCLON	GENERIC PART	22µF	CAPACITOR: SMT (0805); CERAMIC CHIP; 22µF; 6.3V; TOL = 20%; TG = -55°C TO +125°C; TC = X5R
9	C13, C14, C17-C19, C41, C46, C50	-	8	C2012X6S0J226M125AB; GRM21BC80J	TDK/MURATA	22µF	CAPACITOR: SMT (0805); CERAMIC CHIP; 22µF; 6.3V; TOL = 20%; TG = -55°C TO +105°C; TC = X6S
10	C24	-	1	C0402C103K3RAC; GRM155R71E103KA01D; C1005X7R1E103K	KEMET; MURATA; TDK	0.01µF	CAPACITOR: SMT (0402); CERAMIC CHIP; 0.01µF; 25V; TOL = 10%; TG = -55°C TO +125°C; TC = X7R
11	C25, C56	-	2	C0402X7R250-153KNE; GRM155R71E153KA61	VENKEL LTD./MURATA	0.015µF	CAPACITOR: SMT (0402); CERAMIC CHIP; 0.015µF; 25V; TOL = 10%; TG = -55°C TO +125°C; TC = X7R
12	C36	-	1	C0402X5R6R3-105KNP; C1005X5R0J105K; GRM155R60J105KE19; JMK105BJ105KV	VENKEL LTD./TDK/MURATA	1µF	CAPACITOR: SMT (0402); CERAMIC CHIP; 1µF; 6.3V; TOL = 10%; TG = -55°C TO +85°C; TC = X5R
13	C37	-	1	C1005X7R1H682K	TDK	6800PF	CAPACITOR: SMT (0402); CERAMIC CHIP; 6800PF; 50V; TOL = 10%; MODEL = C SERIES; TG = -55°C TO +125°C; TC = X7R
14	C38	-	1	C0402C153K4RAC; GRM155R71C153KA01	KEMET; MURATA	0.015µF	CAPACITOR: SMT (0402); CERAMIC CHIP; 0.015µF; 16V; TOL = 10%; TG = -55°C TO +125°C; TC = X7R
15	C39	-	1	C1005X7R1H222K050BA	TDK	2200PF	CAPACITOR: SMT (0402); CERAMIC CHIP; 2200PF; 50V; TOL = 10%; MODEL = C SERIES; TG = -55°C TO +125°C; TC = X7R
16	D1	-	1	2EZ15D5	MICRO COMMERCIAL COMPONENTS	15V	DIODE: ZNR; THROUGH HOLE-AXIAL LEAD (DO-41); VZ = 15V; IZ = 0.122A
17	TP1-TP3, GND1, VDD1, VOUT	-	6	108-0740-001	EMERSON NETWORK POWER	108-0740-001	CONNECTOR: MALE; PANELMOUNT; BANANA JACK; STRAIGHT; 1PIN
18	J9, VX1, GND2, GND1_HEADER, VDD1_HEADER	-	5	PEC01SAAN	SULLINS ELECTRONICS CORP	PEC01SAAN	CONNECTOR: MALE; THROUGH HOLE; BREAKAWAY; STRAIGHT; 1PIN
19	J2, J6, GND_MAXIMPAD, GND1_MAXIMPAD, VDD1_MAXIMPAD, VOUT_MAXIMPAD	-	6	MAXIMPAD	N/A	MAXIMPAD	EVK KIT PARTS: MAXIM PAD; NO WIRE TO BE SOLDERED ON THE MAXIMPAD
20	J1, J4, J10-J13, J16	-	7	PEC02SAAN	SULLINS	PEC02SAAN	CONNECTOR: MALE; THROUGH HOLE; BREAKAWAY; STRAIGHT; 2PINS

## MAX38801 EV Kit Bill of Materials (continued)

ITEM	REF DES	DN/DNP	QTY	MFG PART #	MANUFACTURER	VALUE	DESCRIPTION
21	J3, J14	-	2	SCOPE_PROBE_JACK	MAXIM	SCOPE_PROBE_JACK	EVKIT PART-SCOPE_PROBE_JACK
22	J5, J15	-	2	PEC030AAN	SULLINS ELECTRONICS CORP.	PEC030AAN	CONNECTOR; MALE; THROUGH HOLE; BREAKAWAY; STRAIGHT THROUGH; 6PINS; -65°C TO +125°C
23	J7	-	1	PEC04SAAN	SULLINS ELECTRONICS CORP.	PEC04SAAN	CONNECTOR; MALE; THROUGH HOLE; BREAKAWAY; STRAIGHT; 4PINS
24	J8	-	1	ED120ZDS	ON-SHORE TECHNOLOGY INC.	ED120ZDS	CONNECTOR; FEMALE; THROUGH HOLE; BLUE TERMINAL BLOCK; STRAIGHT; 2PINS
25	L1	-	1	PCMC063T-R20MIN	SUSUMU CO LTD	PCMC063T-R20MIN	INDUCTOR; SMT; CHOKE; TOL = ±20%; 24A;
26	L1	-	0	7.44373E+11	WURTH ELECTRONICS INC	7.44373E+11	INDUCTOR; SMT; SHIELDED; 0.22µH; TOL = ±30%; 15A;
27	R1	-	1	CR0402-16W-4642FT; CRCW040246K4FK	VENKEL LTD./VISHAY DALE	46.4K	RESISTOR; 0402; 46.4KΩ; 1%; 100PPM; 0.063W; THICK FILM
28	R2, R3	-	2	CRG0402F-10K	TE CONNECTIVITY	10K	RESISTOR; 0402; 10KΩ; 1%; 100PPM; 0.063W; THICK FILM
29	R4, R7, R11, R15, R16	-	5	RC0402JR-070RL; RC0402-16W-000RJT	YAGEO PHYCOMP/VENKEL LTD.	0	RESISTOR; 0402; 0Ω; 5%; JUMPER; 0.063W; THICK FILM
30	R5, R8, R12	-	3	ERJ-2GEJ203K	PANASONIC	20K	RESISTOR; 0402; 20KΩ; 5%; 200PPM; 0.10W; THICK FILM
31	R6, R13	-	2	CRCW0402ZK10FK	VISHAY DALE	2.1K	RESISTOR; 0402; 2.1KΩ; 1%; 100PPM; 0.0625W; THICK FILM
32	R9	-	1	ERA-2AEB2801X	PANASONIC	2.8K	RESISTOR; 0402; 2.8KΩ; 0.1%; 25PPM; 0.063W; METAL FILM
33	R10	-	1	CRCW04021K00JK	VISHAY DALE	1K	RESISTOR; 0402; 1KΩ; 5%; 100PPM; 0.063W; METAL FILM
34	R14	-	1	RCC-0402PW200RF	INTERNATIONAL MANUFACTURING SERVICE	200	RESISTOR; 0402; 200Ω; 1%; 100PPM; 0.080W; THICK FILM
35	SU1-SU5	-	5	STC02SYAN	SULLINS ELECTRONICS CORP.	STC02SYAN	TEST POINT; JUMPER; STR; TOTAL LENGTH = 0.256IN; BLACK; INSULATION=PBT CONTACT=PHOSPHOR BRONZE; COPPER PLATED TIN OVERALL
36	U1	-	1	MAX38801HCS+	MAXIM	MAX38801HCS+	EVKIT PART-IC; VREG; INTEGRATED; STEP-DOWN SWITCHING REGULATOR WITH SELECTABLE APPLICATION CONFIGURATION; CSP19
37	U2	-	1	LP2992AIM5-1.8INOPB	TEXAS INSTRUMENTS	LP2992AIM5-1.8INOPB	IC; VREG; MICROPOWER 250-mA LOW-NOISE ULTRALOW-DROPOUT REGULATOR DESIGNED FOR USE WITH VERY LOW-ESR OUTPUT CAPACITOR; SOT23-5
38	U3	-	1	LP2992AIM5-3.3INOPB	TEXAS INSTRUMENTS	LP2992AIM5-3.3INOPB	IC; VREG; MICROPOWER 250-mA LOW-NOISE ULTRALOW-DROPOUT REGULATOR DESIGNED FOR USE WITH VERY LOW-ESR OUTPUT CAPACITOR; SOT23-5
39	PCB	-	1	MAX38801	MAXIM	PCB	PCB:MAX38801
40	C28, C29	DNP	0	N/A	N/A	OPEN	PACKAGE OUTLINE 7343 HEIGHT 4.3MM ELECTROLYTIC CAPACITOR
41	C30, C33, C40, C43, C45, C47-C49, C52, C53, C22, C26, C27	DNP	0	N/A	N/A	OPEN	PACKAGE OUTLINE 0805 NON-POLAR CAPACITOR
42	C51, C57	DNP	0	N/A	N/A	OPEN	PACKAGE OUTLINE 0402 NON-POLAR CAPACITOR
43	R17	DNP	0	N/A	N/A	OPEN	PACKAGE OUTLINE 0402 RESISTOR
44	L1	DNP	0	74439344001	WURTH ELECTRONICS INC	74439344001	INDUCTOR; SMT; SHIELDED; 0.18µH; TOL = ±20%; 20A;

MAX38801 EV Kit Schematic

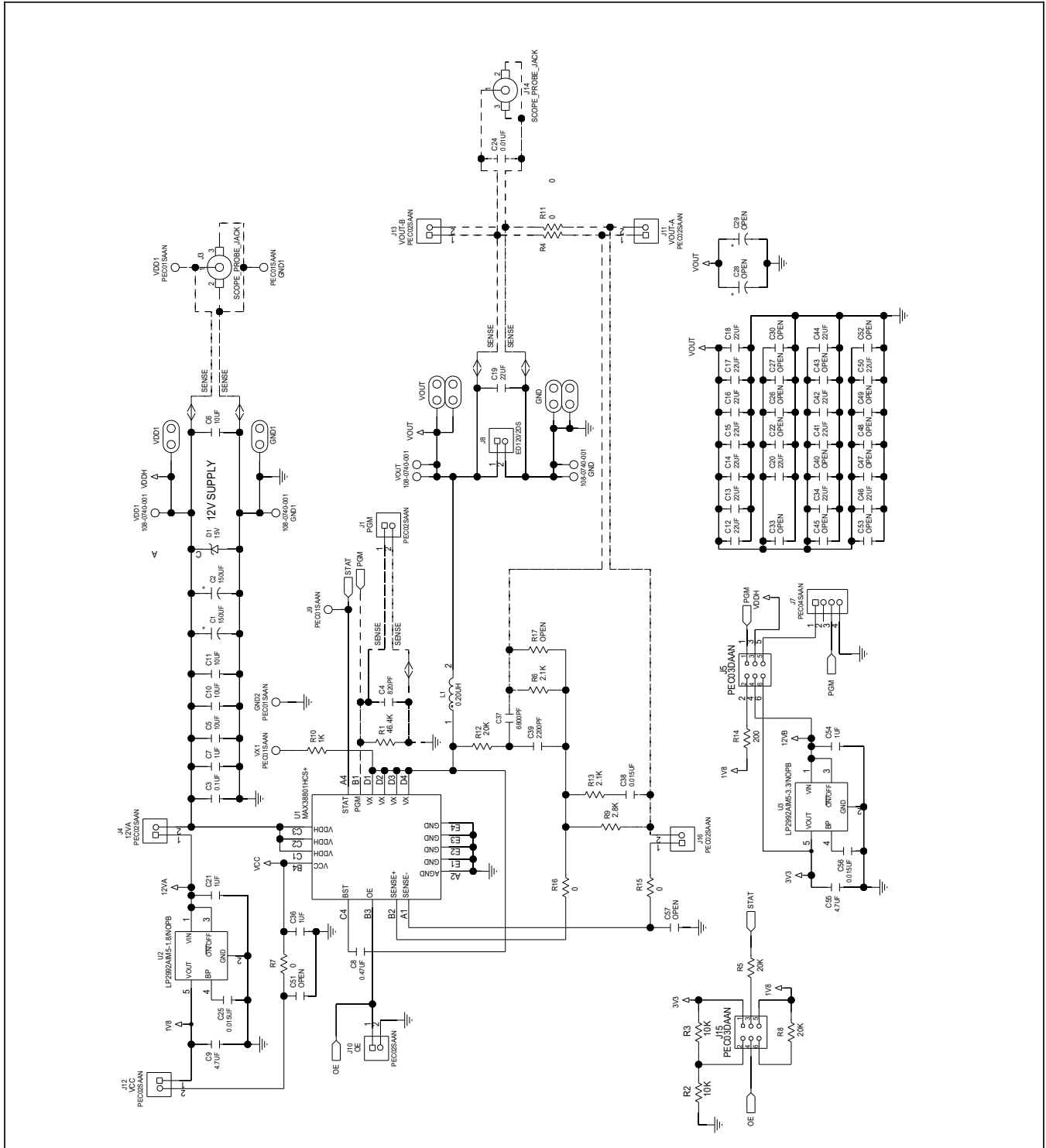

MAX38801 EV Kit PCB Layout Diagrams

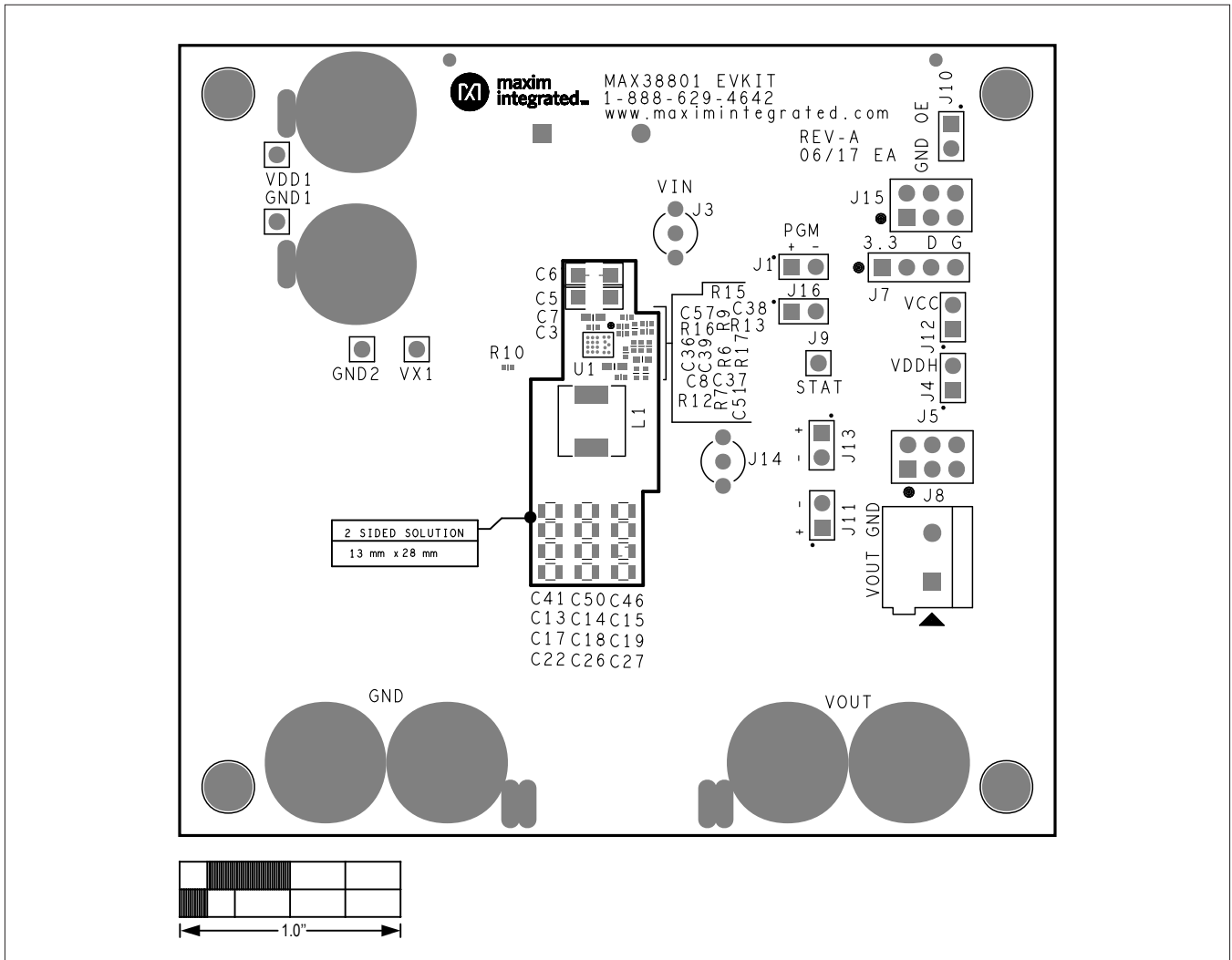

MAX38801 EV Kit—Top Silkscreen

MAX38801 EV Kit PCB Layout Diagrams (continued)

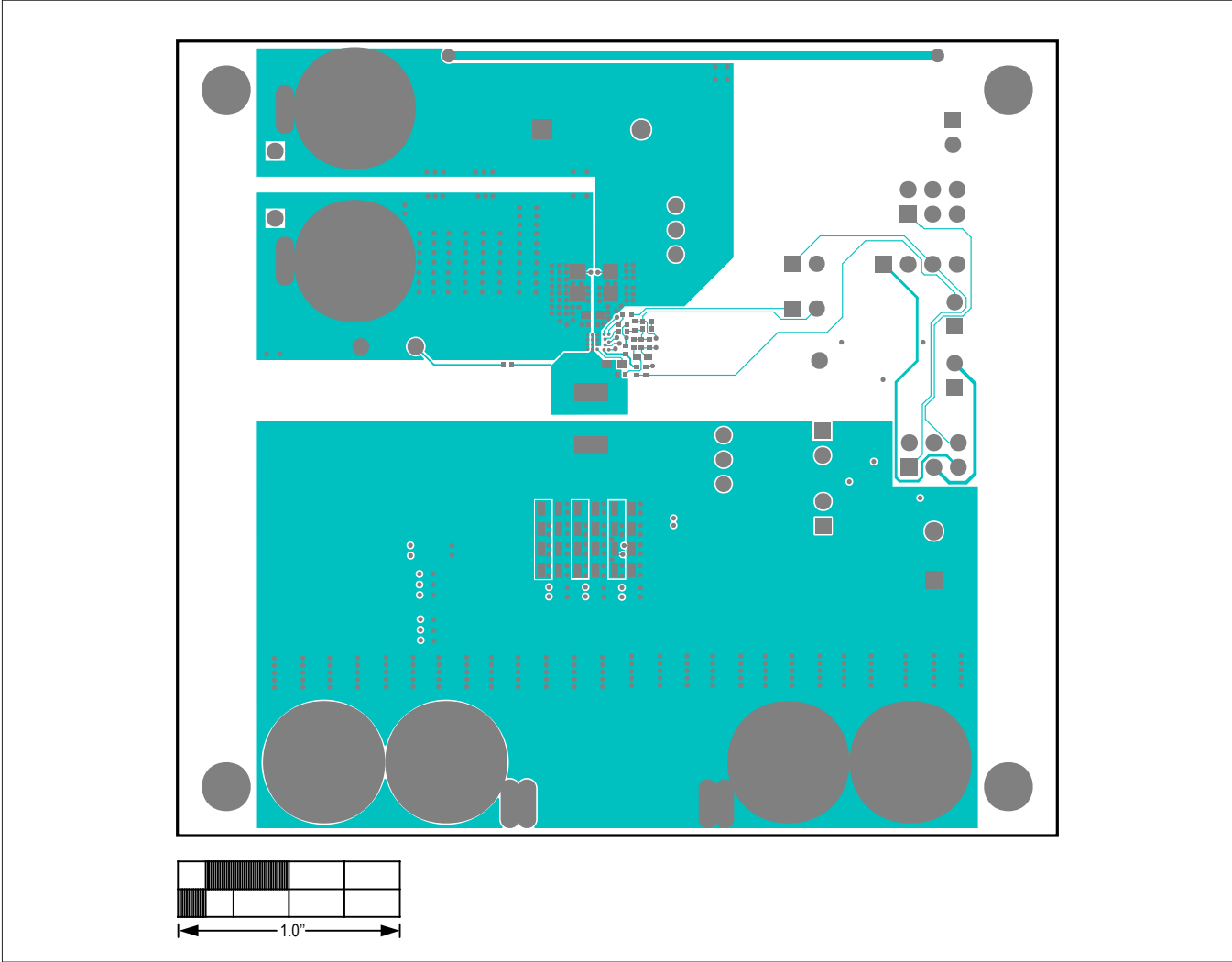

MAX38801 EV Kit—Top View

MAX38801 EV Kit PCB Layout Diagrams (continued)

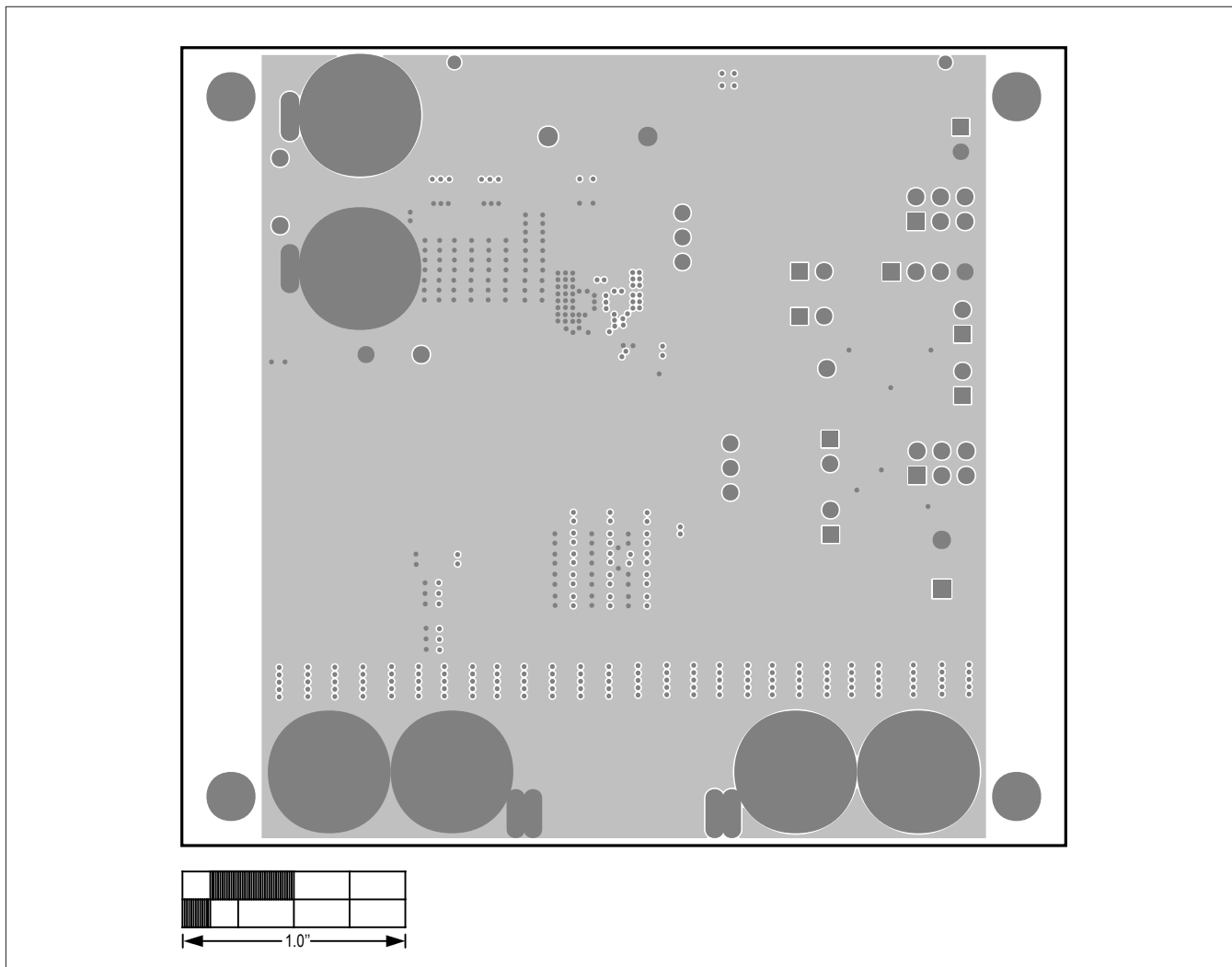

MAX38801 EV Kit—Second Layer

MAX38801 EV Kit PCB Layout Diagrams (continued)

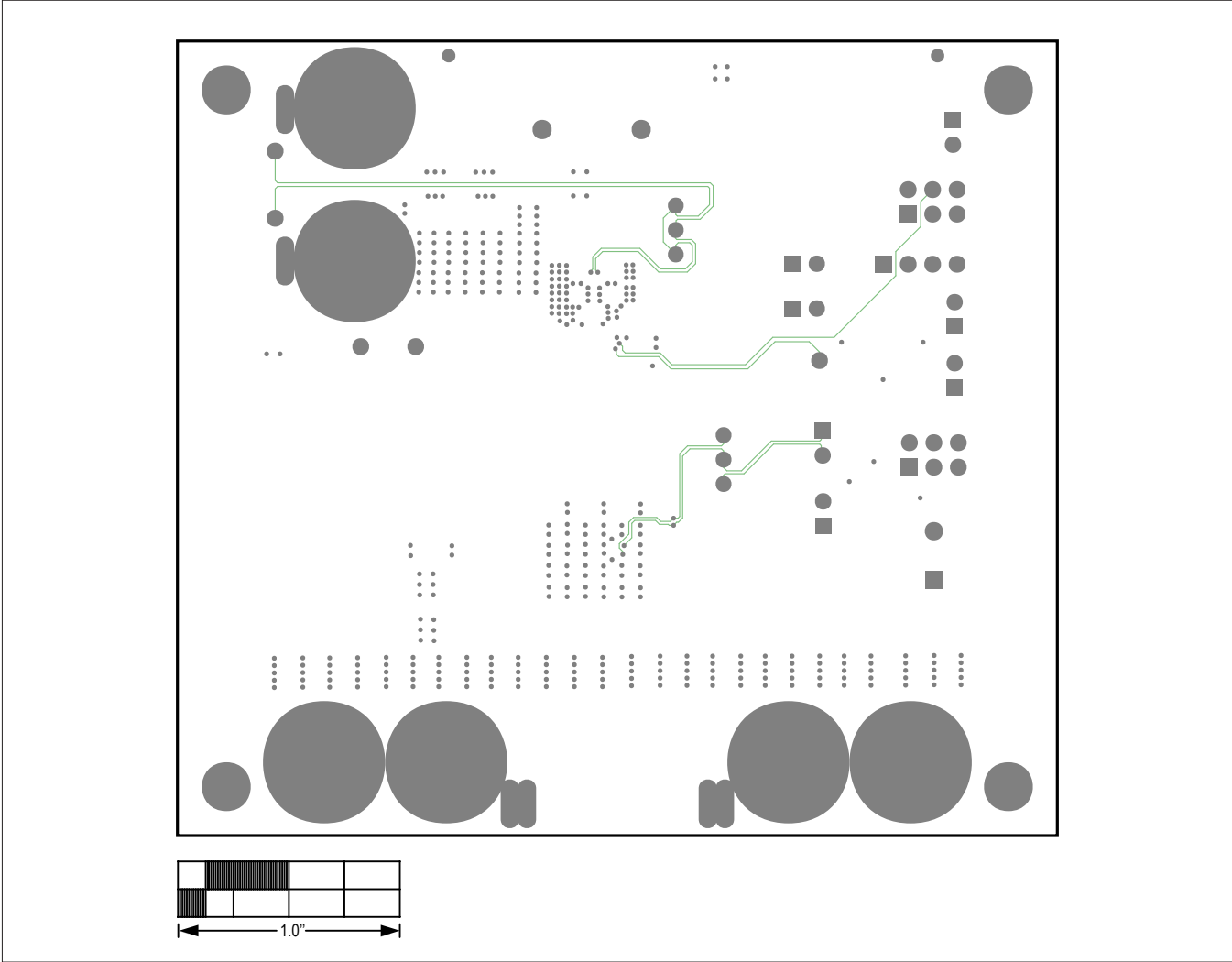

MAX38801 EV Kit—Third Layer



MAX38801 EV Kit PCB Layout Diagrams (continued)

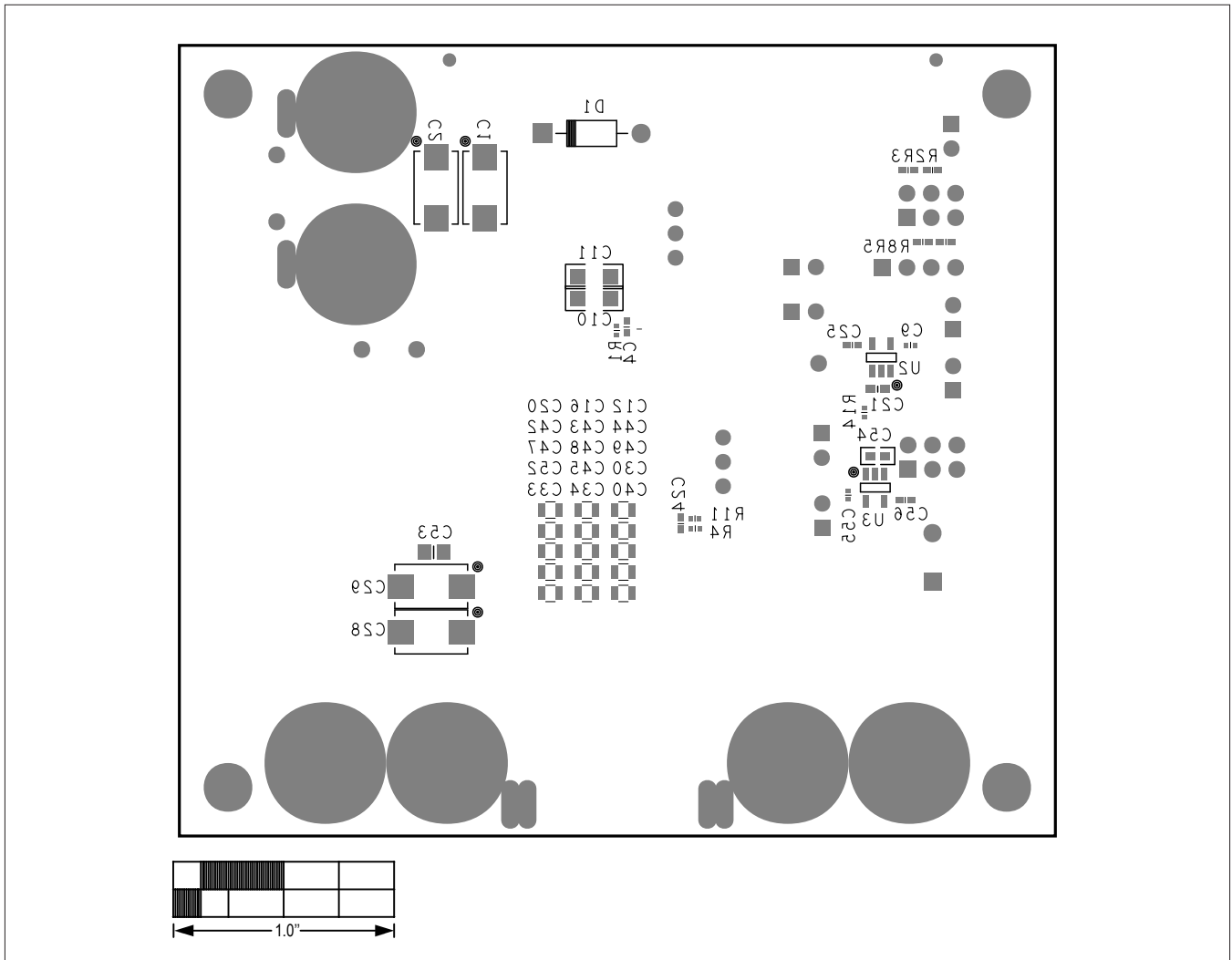

MAX38801 EV Kit—Bottom Silkscreen

### Ordering Information

PART	TYPE
MAX38801EVKIT#	EV Kit

*#Denotes an RoHS-compliant device*

## Revision History

REVISION NUMBER	REVISION DATE	DESCRIPTION	PAGES CHANGED
0	8/17	Initial release	—

For pricing, delivery, and ordering information, please contact Maxim Direct at 1-888-629-4642, or visit Maxim Integrated's website at [www.maximintegrated.com](http://www.maximintegrated.com).

*Maxim Integrated cannot assume responsibility for use of any circuitry other than circuitry entirely embodied in a Maxim Integrated product. No circuit patent licenses are implied. Maxim Integrated reserves the right to change the circuitry and specifications without notice at any time.*