

# Features

# Regulated Converters

- 2:1 Wide Input Voltage Range
- 1.6kVDC Isolation
- UL Certified
- Efficiency up to 89%
- Six-Sided Continuous Shield
- No Minimum Load



## RP20-F

20 Watt  
2" x 1"  
Single & Dual Output



### Description

The RP20-F series DC/DC converters are certified to UL 60950-1 and to cUL 60950-1. This makes them ideal for all telecom and industrial applications where approved safety standards are required. The industry standard 2" x 1" package meets military standards for thermal shock and vibration tolerance.

### Selection Guide

Part Number	Input Voltage Range [VDC]	Output Voltage [VDC]	Output Current [mA]	Input <sup>(1)</sup> Current [mA]	Efficiency <sup>(1)</sup> typ. [%]	Max. Capacitive Load <sup>(2)</sup> [μF]
RP20-123.3SF <sup>(3,4)</sup>	9-18	3.3	5000	1618	85	13000
RP20-1205SF <sup>(3,4)</sup>	9-18	5	4000	1916	87	6800
RP20-1212SF <sup>(3,4)</sup>	9-18	12	1670	1942	86	2200
RP20-1215SF <sup>(3,4)</sup>	9-18	15	1330	1933	86	755
RP20-243.3SF <sup>(3,4)</sup>	18-36	3.3	5000	799	86	13000
RP20-2405SF <sup>(3,4)</sup>	18-36	5	4000	936	89	6800
RP20-2412SF <sup>(3,4)</sup>	18-36	12	1670	960	87	2200
RP20-2415SF <sup>(3,4)</sup>	18-36	15	1330	955	87	755
RP20-483.3SF <sup>(3,4)</sup>	36-75	3.3	5000	395	87	13000
RP20-4805SF <sup>(3,4)</sup>	36-75	5	4000	468	89	6800
RP20-4812SF <sup>(3,4)</sup>	36-75	12	1670	474	88	2200
RP20-4815SF <sup>(3,4)</sup>	36-75	15	1330	477	87	755
RP20-1212DF <sup>(3,4)</sup>	9-18	±12	±833	1937	86	±680
RP20-1215DF <sup>(3,4)</sup>	9-18	±15	±667	1938	86	±450
RP20-2412DF <sup>(3,4)</sup>	18-36	±12	±833	957	87	±680
RP20-2415DF <sup>(3,4)</sup>	18-36	±15	±667	947	88	±450
RP20-4812DF <sup>(3,4)</sup>	36-75	±12	±833	473	88	±680
RP20-4815DF <sup>(3,4)</sup>	36-75	±15	±667	473	88	±450



#### Notes:

- Note1: Maximum value at nominal input voltage and full load.  
Note2: Test by minimum Vin and constant resistor load.



### Model Numbering

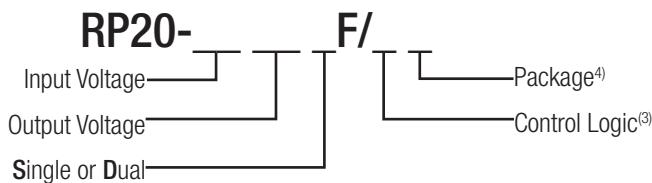

#### Ordering Examples

- RP20-2405SF = 24V Input, 5V Output, Positive Logic CTRL pin fitted  
RP20-4812DF/N-HC = 48V Input, ±12V Output, Negative Logic CTRL pin fitted, Heat-sink fitted (no trim pin available with dual output)

#### Notes:

- Note3: no suffix for CTRL function with Positive Logic (1=ON, 0=OFF), and trim pin add "N" for CTRL function with Negative Logic (0=ON, 1=OFF), and trim pin  
Note4: add suffix -HC for premounted Heat-sink and clips

UL60950-1 Certified

**Specifications** measured at Ta = 25°C, nominal input voltage, full load otherwise noted

**BASIC CHARACTERISTICS**

Parameter	Condition	Min.	Typ.	Max.
Input Voltage Range	nom. Vin = 12V nom. Vin = 24V nom. Vin = 48V	9VDC 18VDC 36VDC	12VDC 24VDC 48VDC	18VDC 36VDC 75VDC
Undervoltage Lockout (ULVO)				none
Input Filter <sup>(5)</sup>				L-C Type
Input Reflected Ripple Current <sup>(6)</sup>	nominal Vin and full load		20mA <sub>p-p</sub>	
Input Surge Voltage	Vin = 12V, 100ms max. Vin = 24V, 100ms max. Vin = 48V, 100ms max.			36VDC 50VDC 100VDC
Start-up time	Power up Remote ON/OFF		10ms 10ms	
Operating Frequency Range		450kHz	500kHz	550kHz
Minimum Load <sup>(7)</sup>	Single Dual	0% ±10%		
Optional Output Trim				±10%
Ripple and Noise	measured by 20MHz bandwidth with a 0.1µF/50V MLCC	Single 3.3Vout Single 5Vout, 12Vout, 15Vout Dual All	60mV <sub>p-p</sub> 75mV <sub>p-p</sub> 100mV <sub>p-p</sub>	
Remote ON/OFF <sup>(8)</sup>	Positive Logic Negative Logic	DC-DC ON DC-DC OFF DC-DC ON DC-DC OFF		Open or 3.0V < Vr < 12V Short or 0V < Vr < 1.2V Short or 0V < Vr < 1.2V Open or 3.0V < Vr < 12V
Input current of Remote pin (CTRL)		DC-DC OFF DC-DC ON		2.5mA -0.5mA 0.5mA

**Notes:**

Note5: An external filter capacitor is required for normal operation. The capacitor should be capable of handling 1A ripple current for 48V/24V models. RECOM suggest: Nippon chemi-con KY series, 220µF/100V, ESR 90m Ω.

Note6: Simulated source impedance of 12µH. 12µH inductor in series with +Vin.

Note7: The RP20-F series requires a minimum of 10% loading on the output to maintain specified regulation. Operation under no-load condition will not damage these devices, however they may not meet all listed specification.

Note8: The ON/OFF control function can be positive or negative logic. The pin voltage is referenced to -Vin pin.

**RP20-1205SF**

**Efficiency vs. Output Current**

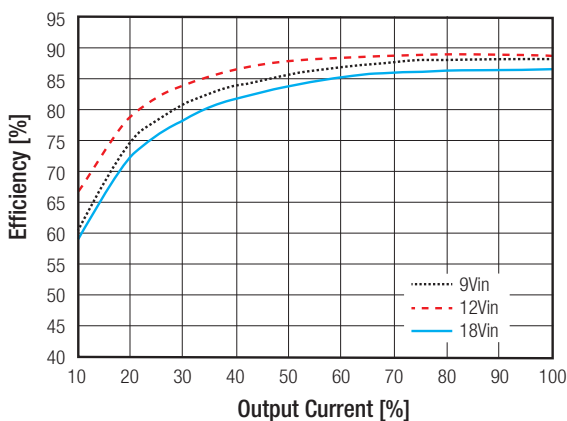

**Efficiency vs. Input Voltage**

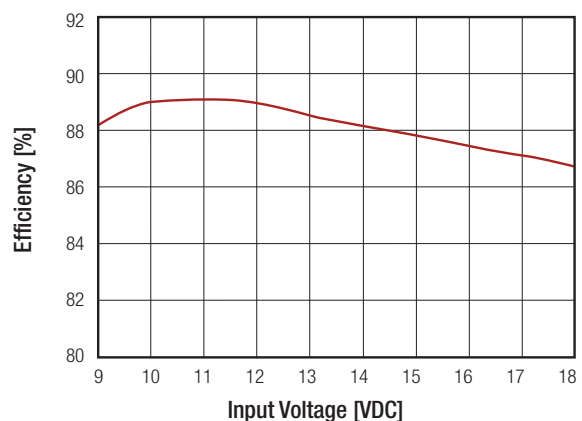

continued on next page

Specifications measured at Ta = 25°C, nominal input voltage, full load otherwise noted

**RP20-2405SF**

Efficiency vs. Output Current

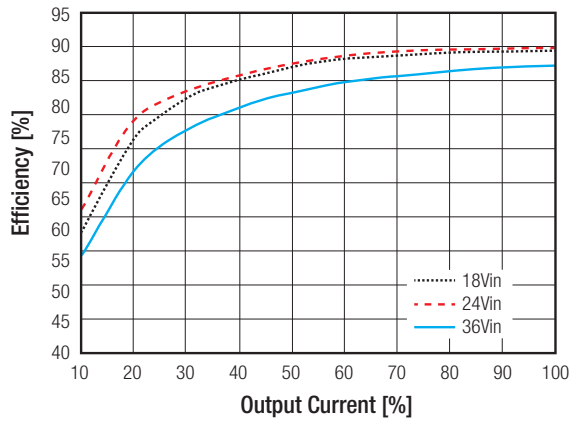

Efficiency vs. Input Voltage

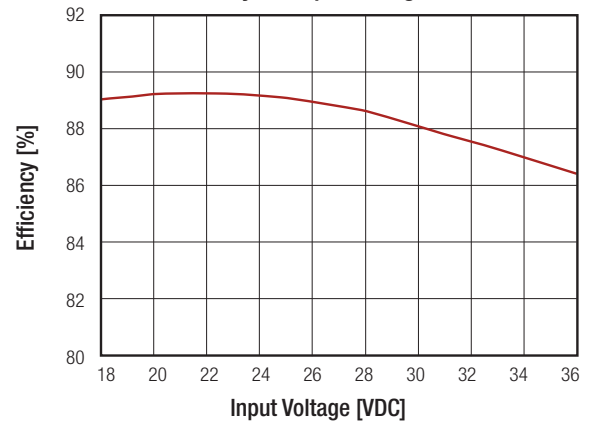

**RP20-4805SF**

Efficiency vs. Output Current

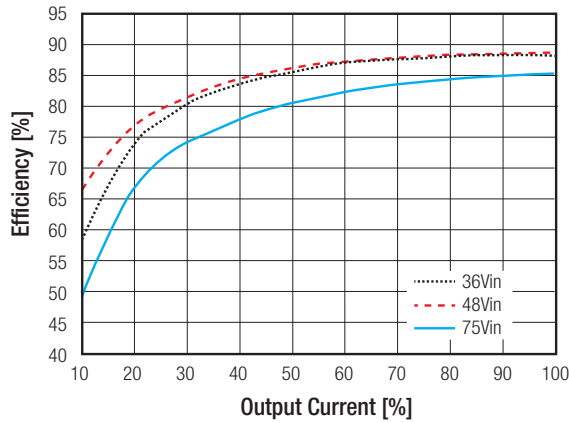

Efficiency vs. Input Voltage

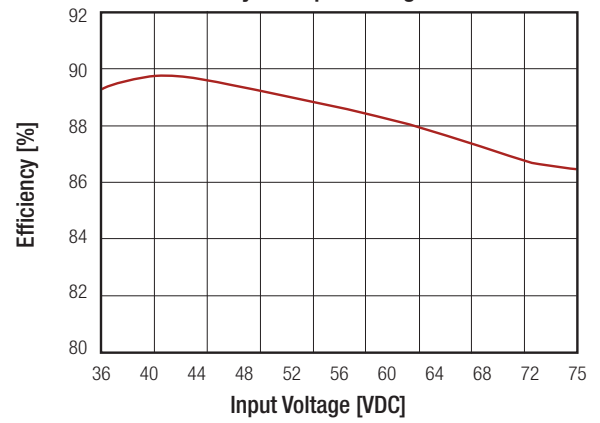

**REGULATIONS**

Parameter	Condition	Value
Output Voltage Accuracy	full load and nominal Vin	±1%
Voltage Adjustability	Single	±10%
Line Voltage Regulation	low line to high line at full load	±0.2%
Load Voltage Regulation	no load to full load	±0.5%
Cross Regulation	asymmetrical 25% <> 100% load	±5%
Transient Response recovery time	25% load step change	250µs

**External Output Trimming**

**Output Voltage Trimming**

Single output Powerline converters offer the feature of trimming the output voltage over a certain range around the nominal value by using external trim resistors. No general equation can be given for calculating the trim resistors, but the following trimtables give typical values for choosing these trimming resistors. If voltages between the given trim points are required, extrapolate between the two nearest given values to work out the resistor required or use a variable resistor to set the output voltage. Output can be externally trimmed by using the method shown below.

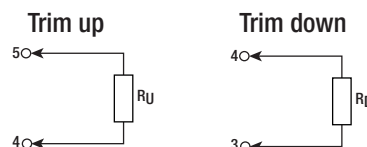

continued on next page

**Specifications** measured at Ta = 25°C, nominal input voltage, full load otherwise noted

RP20-xx3.3SF											
Trim up	1	2	3	4	5	6	7	8	9	10	%
Vout =	3.333	3.366	3.399	3.432	3.465	3.498	3.531	3.564	3.597	3.63	Volts
R <sub>U</sub> =	57.93	26.16	15.58	10.28	7.11	4.99	3.48	2.34	1.46	0.75	KOhms
Trim down	1	2	3	4	5	6	7	8	9	10	%
Vout =	3.267	3.234	3.201	3.168	3.135	3.102	3.069	3.036	3.003	2.97	Volts
R <sub>D</sub> =	69.47	31.23	18.49	12.12	8.29	5.74	3.92	2.56	1.50	0.65	KOhms
RP20-xx05SF											
Trim up	1	2	3	4	5	6	7	8	9	10	%
Vout =	5.05	5.10	5.15	5.20	5.25	5.30	5.35	5.4	5.45	5.50	Volts
R <sub>U</sub> =	36.57	16.58	9.92	6.58	4.59	3.25	2.30	1.59	1.03	0.59	KOhms
Trim down	1	2	3	4	5	6	7	8	9	10	%
Vout =	4.95	4.90	4.85	4.80	4.75	4.70	4.65	4.60	4.55	4.50	Volts
R <sub>D</sub> =	45.53	20.61	12.31	8.15	5.66	4.00	2.81	1.92	1.23	0.68	KOhms
RP20-xx12SF											
Trim up	1	2	3	4	5	6	7	8	9	10	%
Vout =	12.12	12.24	12.36	12.48	12.60	12.72	12.84	12.96	13.08	13.20	Volts
R <sub>U</sub> =	367.91	165.95	98.64	64.98	44.78	31.32	21.70	14.49	8.88	4.39	KOhms
Trim down	1	2	3	4	5	6	7	8	9	10	%
Vout =	11.88	11.76	11.64	11.52	11.40	11.28	11.16	11.04	10.92	10.8	Volts
R <sub>D</sub> =	460.99	207.95	123.60	81.42	56.12	39.25	27.20	18.16	11.13	5.51	KOhms
RP20-xx15SF											
Trim up	1	2	3	4	5	6	7	8	9	10	%
Vout =	15.15	15.3	15.45	15.60	15.75	15.90	16.05	16.20	16.35	16.50	Volts
R <sub>U</sub> =	404.18	180.59	106.06	68.80	46.44	31.53	20.88	12.90	6.69	1.72	KOhms
Trim down	1	2	3	4	5	6	7	8	9	10	%
Vout =	14.85	14.70	14.55	14.40	14.25	14.10	13.95	13.80	13.65	13.50	Volts
R <sub>D</sub> =	499.82	223.41	131.27	85.20	57.56	39.14	25.97	16.10	8.42	2.282	KOhms

PROTECTIONS			
Parameter	Condition	Value	
Short Circuit Protection (SCP)		continuous, automatic recovery	
Over Voltage Protection (OVP)	Zener Diode Clamp	3.3Vout	3.9VDC
		5Vout	6.2VDC
		12Vout	15VDC
		15Vout	18VDC
Over Load Protection (OLP)	% of Iout rated	150% typ.	
Isolation Voltage	I/P to O/P	1.6kVDC/1 minute	
	I/P to O/P to case	1.6kVDC/1 minute	
Isolation Resistance	500 VDC	1GΩ min.	
Isolation Capacitance		1000pF max.	
<b>Notes:</b> Note9: This power module is not internally fused. An input line fuse must always be used.			

**Specifications** measured at Ta = 25°C, nominal input voltage, full load otherwise noted

ENVIRONMENTAL		
Parameter	Condition	Value
Operating Temperature Range	without derating with derating	-40°C to +70°C -40°C to +100°C
Maximum Case Temperature		+100°C
Temperature Coefficient		±0.02%/°C max.
Thermal Impedance	Natural convection (20LFM) Natural convection (20LFM) with Heat-sink	12°C/Watt 10°C/Watt
Operating Humidity		5% - 95% RH
Thermal Shock		MIL-STD-810F
Vibration		MIL-STD-810F
MTBF	MIL-HDBK-217F, full load BELLCORE TR-NWT-000332 <sup>(10)</sup>	1583 x 10 <sup>3</sup> hours 1791 x 10 <sup>3</sup> hours

**Derating Graph<sup>(11)</sup>**

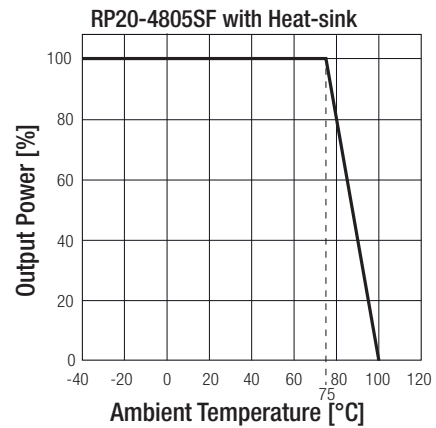
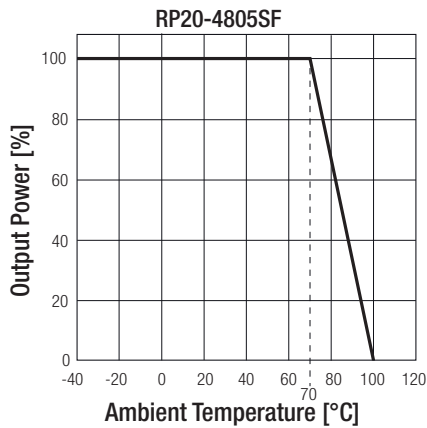

**Notes:**

Note10: BELLCORE TR-NWT-000332. Case I: 50% Stress, Temperature at 40°C (Ground fixed and controlled environment).  
 Note11: Derating graphs are valid only for the shown part numbers. If you need detailed derating-information about a part-number not shown here please contact our technical support service at techsupportAT@recom-power.com

SAFETY AND CERTIFICATIONS		
Certificate Type (Safety)	Report / File Number	Standard
UL General Safety	E196683	UL60950-1 1st Ed.: 2003 C22.2 No. 60950 1st. Ed.: 2003
EMC Compliance	Condition	Standard / Criterion
EMI Standard <sup>(12)</sup>	with external filter	EN55022, Class A or B
ESD	Air ±8kV and Contact ±6kV	EN61000-4-2, Criteria B
Radiated Immunity	10 V/m	EN61000-4-3, Criteria A
Fast Transient <sup>(13)</sup>	±2kV	EN61000-4-4, Criteria B
Surge <sup>(13)</sup>	±1kV	EN61000-4-5, Criteria B
Conducted Immunity	10 Vr.m.s	EN61000-4-6, Criteria A
<b>Notes:</b>		
Note12: The standard modules meet EMI Class A or Class B with external components, see filter suggestions below.		
Note13: An external input filter capacitor is required if the module has to meet EN61000-4-4, EN61000-4-5. The filter capacitor Recom suggests: Nippon chemi-con KY series, 220µF/100V		

continued on next page

Specifications measured at  $T_a = 25^\circ\text{C}$ , nominal input voltage, full load otherwise noted

### EMI Filtering Class A

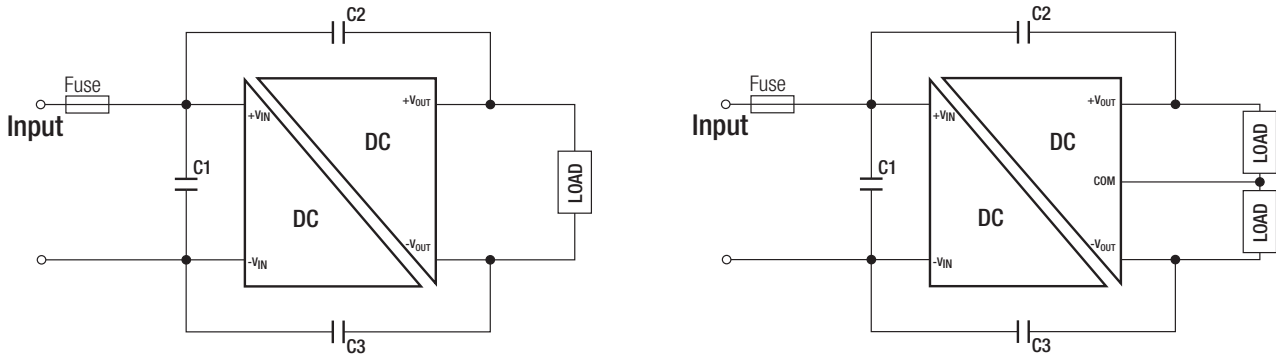

MODEL	C1	C2	C3
RP20-12xxSF RP20-12xxDF	4.7 $\mu\text{F}$ /50V 1812 MLCC	1000pF/2kV 1808 MLCC	1000pF/2kV 1808 MLCC
RP20-24xxSF RP20-24xxDF	2.2 $\mu\text{F}$ /50V 1812 MLCC	1000pF/2kV 1808 MLCC	1000pF/2kV 1808 MLCC
RP20-48xxSF RP20-48xxDF	2.2 $\mu\text{F}$ /100V 1812 MLCC	1000pF/2kV 1808 MLCC	1000pF/2kV 1808 MLCC

### EMI Filtering Class B

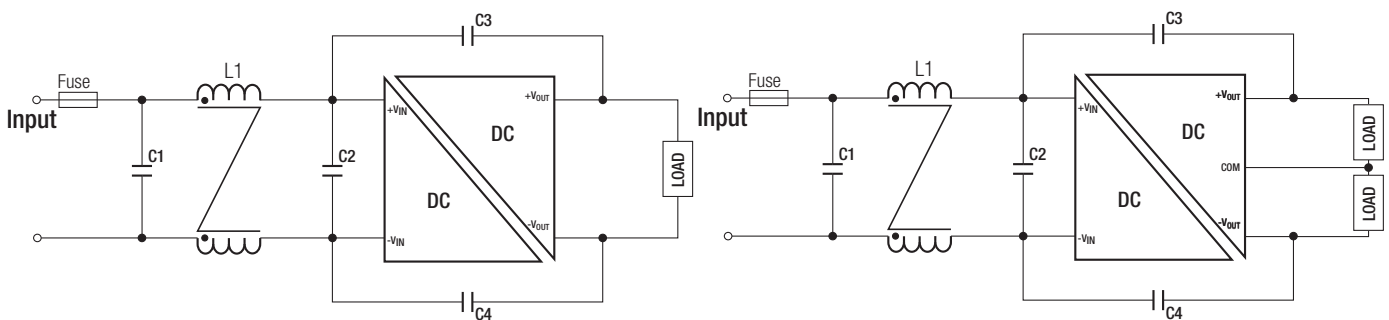

MODEL	C1	C2	C3/C4	L1
RP20-12xxSF RP20-12xxDF	3.3 $\mu\text{F}$ /50V 1812 MLCC	3.3 $\mu\text{F}$ /50V 1812 MLCC	1000pF/2kV 1808 MLCC	CMC: 450 $\mu\text{H}$ ref.: WE 74482270005 ref.: CMC-05
RP20-24xxSF RP20-24xxDF	4.7 $\mu\text{F}$ /50V 1812 MLCC	N/A	1000pF/2kV 1808 MLCC	CMC: 450 $\mu\text{H}$ ref.: WE 74482270005 ref.: CMC-05
RP20-48xxSF RP20-48xxDF	2.2 $\mu\text{F}$ /100V 1812 MLCC	2.2 $\mu\text{F}$ /100V 1812 MLCC	1000pF/2kV 1808 MLCC	CMC: 450 $\mu\text{H}$ ref.: WE 74482270005 ref.: CMC-05

**Specifications** measured at Ta = 25°C, nominal input voltage, full load otherwise noted

**DIMENSIONS and PHYSICAL CHARACTERISTICS**

Parameter	Type	Value
Material	Case	Nickel coated copper
	Base	Non-conductive black plastic
	Potting	Epoxy (UL94-V0)
Package Dimensions (LxWxH)	without Heat-sink	50.8 x 25.4 x 10.2mm
	with Heat-sink	56.8 x 25.4 x 16.8mm
Package Weight	without Heat-sink	27g
	with Heat-sink	37.89g

**Dimension Drawing (mm)**

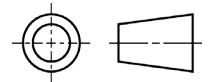
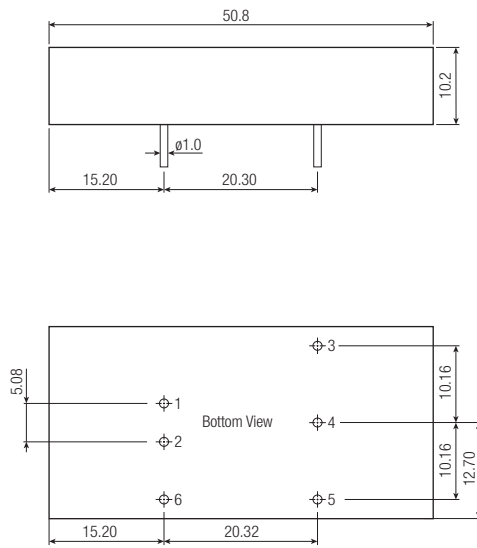

**Pin Connections**

Pin #	Single	Dual
1	+Vin	+Vin
2	-Vin	-Vin
3	+Vout	+Vout
4	Trim	Com
5	-Vout	-Vout
6	CTRL	CTRL

Pin Pitch Tolerance  $\pm 0.25$  mm  
 Pin dimension tolerance  $\pm 0.1$  mm  
 Tolerance: X.X  $\pm 0.5$  mm  
 X.XX  $\pm 0.25$  mm

**Dimension Drawing (mm) with Heat-sink**

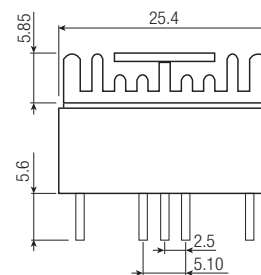
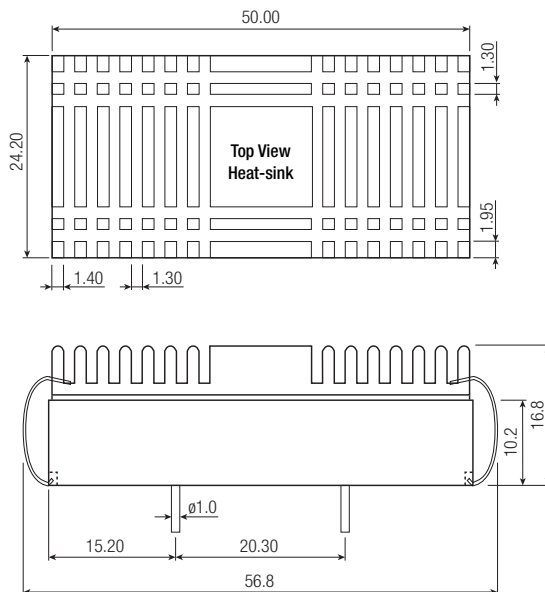

**Specifications** measured at Ta = 25°C, nominal input voltage, full load otherwise noted

PACKAGING INFORMATION		
Parameter	Type	Value
Packaging Quantity	without Heat-sink	9pcs.
	with Heat-sink	20pcs.
Storage Temperature Range		-55°C to +125°C
Storage Humidity		5% - 95% RH