

Features

- Low power loss, high efficiency.
- High current capability, low forward voltage drop.
- High surge capability.
- Guardring for overvoltage protection.
- Ultra high-speed switching.
- Silicon epitaxial planar chip, metal silicon junction. Suffix "H" indicates Halogen-free part, ex.MBR2040CTH-J. Lead-free parts meet environmental standards of MIL-STD-19500 /228

Mechanical data

- Epoxy : UL94-V0 rated flame retardant.
- Case : JEDEC TO-220AB molded plastic body over passivated chip.
- Lead : Axial leads, solderable per MIL-STD-202, Method 208 guaranteed.
- Polarity: Color band denotes cathode end.
- Mounting Position : Any.
- Weight : Approximated 2.25 gram.

Maximum ratings and electrical characteristics

Rating at 25°C ambient temperature unless otherwise specified. Single phase, half wave, 60Hz, resistive or inductive load. For capacitive load, derate current by 20%.

Outline

TO-220AB

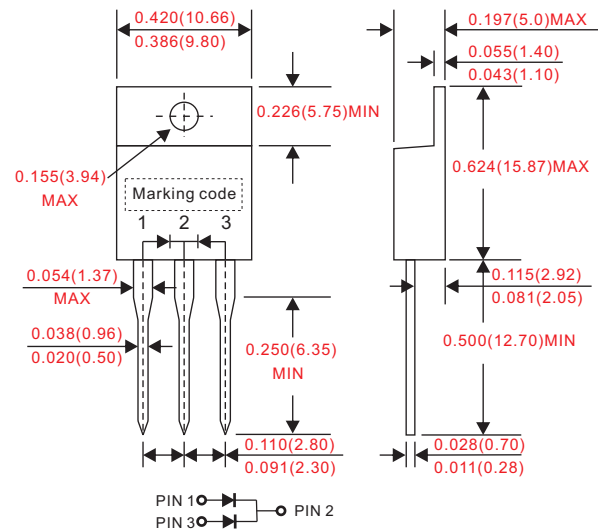

Parameter	Conditions	Symbol	MIN.	TYP.	MAX.	UNIT
Forward rectified current	See Fig.1	I_o			20	A
Forward surge current	8.3ms single half sine-wave superimposed on rate load (JEDEC method)	I_{FSM}			150	A
Reverse current	$V_R = V_{RRM}$ $T_A = 25^\circ\text{C}$	I_R			0.1	mA
	$V_R = V_{RRM}$ $T_A = 125^\circ\text{C}$				10	
Diode junction capacitance	f=1MHz and applied 4V DC reverse voltage	C_j		150		pF
Thermal resistance	Junction to ambient	R_{BJA}		30		°C/W
Storage temperature		T_{STG}	-55		+175	°C

Symbol	Marking code	Max. repetitive peak reverse voltage V_{RRM} (V)	Max. RMS voltage V_{RMS} (V)	Max. DC blocking voltage V_R (V)	Max. forward voltage @10A, $T_A = 25^\circ\text{C}$ V_F (V)	Max. forward voltage @10A, $T_A = 125^\circ\text{C}$ V_F (V)	Operating temperature T_J (°C)
MBR2040CT-J	MBR2040CT	40	28	40	0.70	0.57	-55 ~ +150
MBR2045CT-J	MBR2045CT	45	31.5	45			
MBR2060CT-J	MBR2060CT	60	42	60	0.79	0.70	
MBR2065CT-J	MBR2065CT	65	45.5	65			
MBR20100CT-J	MBR20100CT	100	70	100	0.81	0.71	-55 ~ +175
MBR20150CT-J	MBR20150CT	150	105	150	0.87	0.77	
MBR20200CT-J	MBR20200CT	200	140	200	0.90	0.80	

■ Rating and characteristic curves

Fig. 1 - Forward Current Derating Curve

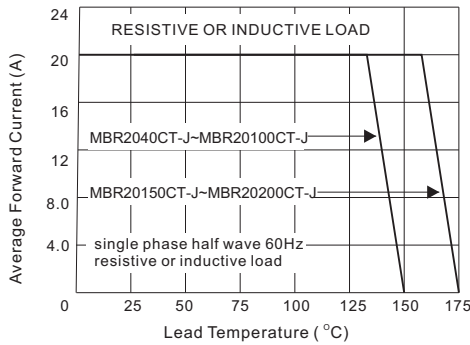

Fig. 2 - Maximum Non-Repetitive Peak Forward Surge Current

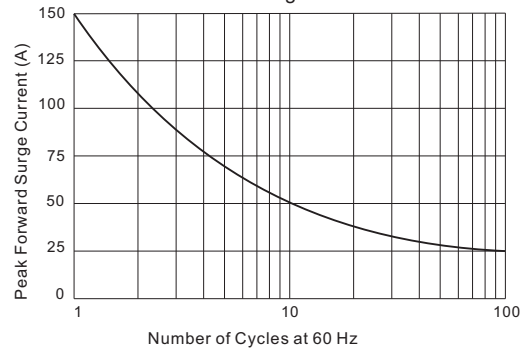

Fig. 3.1 - Instantaneous Forward Characteristics

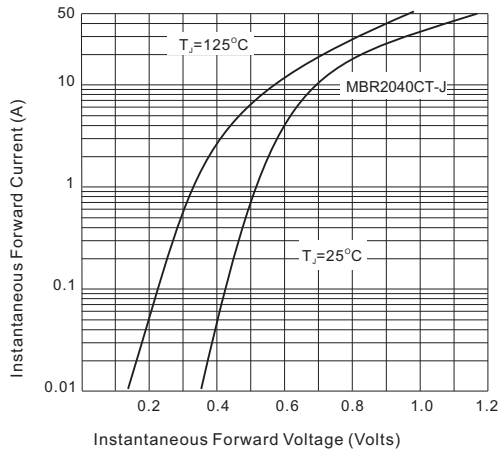

Fig. 3.2 - Instantaneous Forward Characteristics

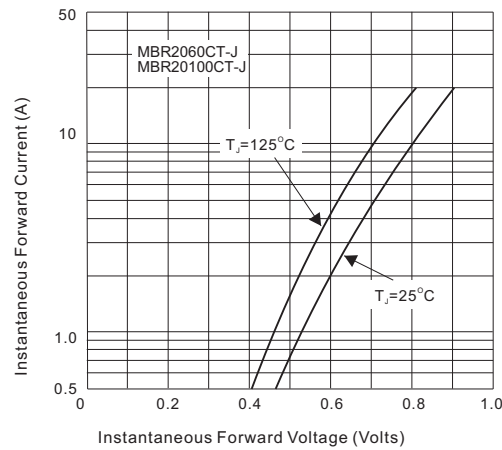

Fig. 3.3 - Instantaneous Forward Characteristics

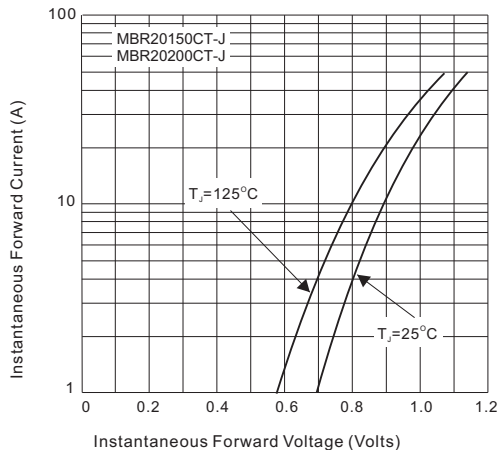
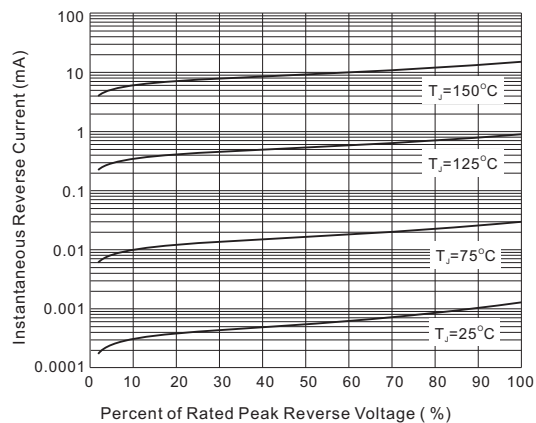

Fig. 4 - Reverse Characteristics



PACKAGE	SPQ/PCS	CARTON SPQ/PCS	CARTON SIZE/CM	CARTON GW/KG	CARTON NW/KG
TO-220AB	50/tube;1000/BOX	5000	58X23.5X18	15.00	13.00