

Switched Low Noise Amplifier 800 - 1000 MHz

AM55-0016
V3

Features

- High Gain State:
 - Gain: 16 dB, Noise Figure: 1.6 dB
 - Input IP3: +3 dBm (@2.7V, 25 mA)
- Low Gain State:
 - Insertion Loss: 5 dB, Input IP3: +24 dBm
- Single Supply: +2.7 to +5 VDC
- Low Cost MSOP-8 Plastic Package
- Adjustable current: 10 to 30 mA with external resistor

Description

M/A-COM's AM55-0016 is a high dynamic range, switchable low noise amplifier in a low cost, MSOP 8-lead, surface mount, plastic package. The design utilizes a patented switching technique to provide a low insertion loss, high input IP₃ bypass state in parallel with the high gain, low noise state.

The LNA employs external input matching to obtain optimum noise figure performance and operating frequency flexibility. The AM55-0016 also features flexible biasing to control the current consumption vs. dynamic range trade-off. It's current can be controlled over a range of 10 mA to 30 mA with an external resistor.

Typical applications include receiver front ends in cellular band CDMA handsets. It is also useful as a switched gain block, buffer or driver in portable cellular systems.

The AM55-0016 is fabricated using a low-cost 0.5-micron gate length GaAs MESFET process. The process features full passivation for increased performance and reliability.

Ordering Information ¹

Part Number	Package
AM55-0016	MSOP-8 Lead Plastic Package
AM55-0016TR	Forward Tape and Reel
AM55-0016SMB	Sample Test Board

1. Reference Application Note M513 for reel size information.

Functional Block Diagram

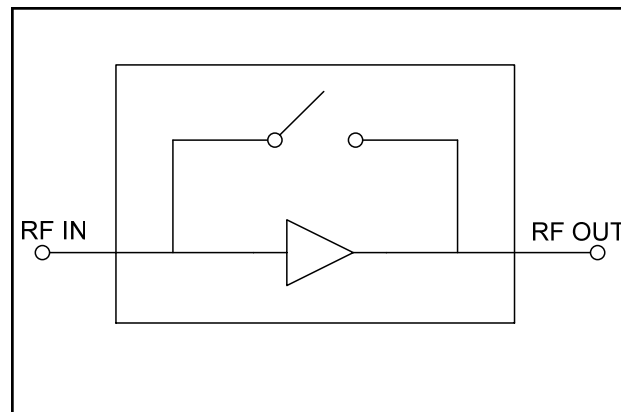

Pin Configuration

Pin No.	Pin Name	Description
1	VDD1	Stage 1 Supply Voltage
2	IN	RF Input
3	VS1	Stage 1 Source
4	GND	RF and DC Ground
5	VS2	Stage 2 Source
6	OUT	RF Output
7	VDD2	Stage 2 Supply Voltage
8	VCTL	Switch Control Voltage

Absolute Maximum Ratings ^{2,3,4}

Parameter	Absolute Maximum
V _{DD}	+6 VDC
Input Power	0 dBm
Current	30 mA
Channel Temperature ⁴	+150°C
Operating Temperature	-40°C to +85°C
Storage Temperature	-65°C to +150°C

2. Exceeding any one or combination of these limits may cause permanent damage to this device.
3. M/A-COM does not recommend sustained operation near these survivability limits.
4. Typical thermal resistance (θ_{jc}) = +99°C/W.

Switched Low Noise Amplifier
800 - 1000 MHz

AM55-0016
V3

Electrical Specifications: $T_A = 25^\circ\text{C}$, $Z_0 = 50 \Omega$, $F = 881 \text{ MHz}$, $P_{IN} = -30 \text{ dBm}$, $V_{DD} = 2.7 \text{ V}$, $I_{DD} = 10 \text{ mA}$

Parameter	Test Conditions	Units	Min.	Typ.	Max.
HIGH GAIN STATE, Voltage control = 2.7 volts					
Gain		dB	—	16	—
Noise Figure		dB	—	1.6	1.8
Input IP3	$I_{DD} = 10 \text{ mA}$, $V_{DD} = 2.7 \text{ V}$ $I_{DD} = 25 \text{ mA}$, $V_{DD} = 2.7 \text{ V}$	dBm dBm	— —	-2 +3	— —
Input VSWR / Output VSWR		—	—	2.0:1	—
Reverse Isolation		dB	—	32	—
LOW GAIN STATE, Voltage control = 0 volts					
Insertion Loss	$I_{DD} = 100 \mu\text{A}$	dB	—	5	—
Input IP3		dBm	—	+24	—
Input VSWR		—	—	2.3:1	—
Output VSWR		—	—	2.0:1	—

Handling Procedures

Please observe the following precautions to avoid damage.

Static Sensitivity

Gallium Arsenide Integrated Circuits are sensitive to electrostatic discharge (ESD) and can be damaged by static electricity. Proper ESD control techniques should be used when handling these devices.

Evaluation PCB + RF Connector Losses

Port Reference	Approximate RF Loss
RF IN	0.15 dB @ 900 MHz
RF OUT	0.15 dB @ 900 MHz

The DC connector on the Designer's Kit PCB allows convenient DC line access. This is accomplished by one or more of the following methods:

1. A mating female multi-pin connector (Newark Electronics Stock # 46F-4658, not included).
2. Wires soldered to the necessary pins (not included).
3. Clip leads (not included).

Evaluation Board

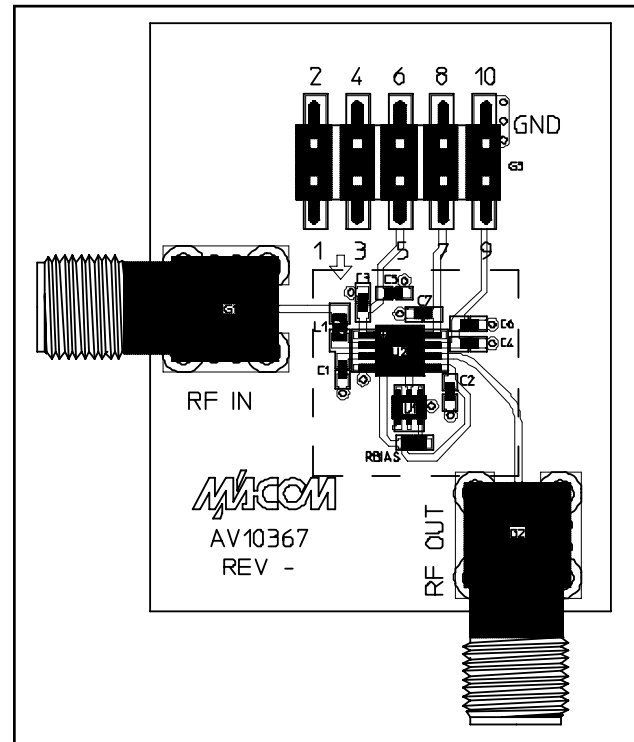

Switched Low Noise Amplifier
800 - 1000 MHz

AM55-0016
V3

Recommended PCB Configuration

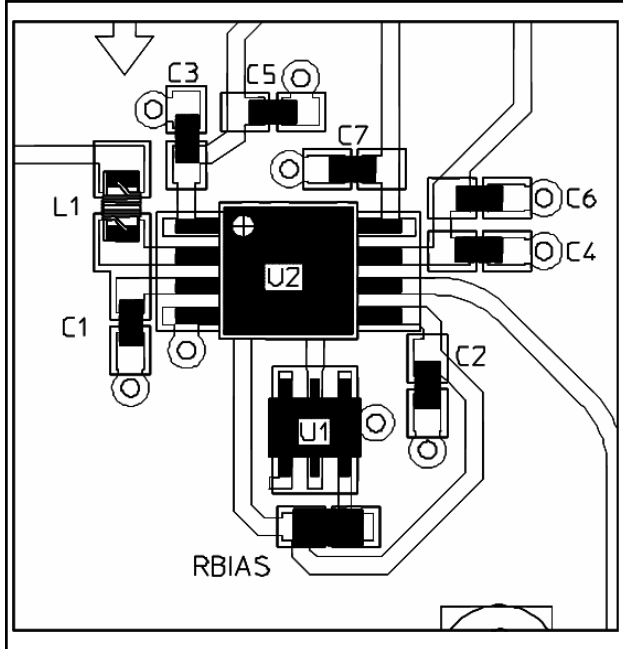

Cross Section View

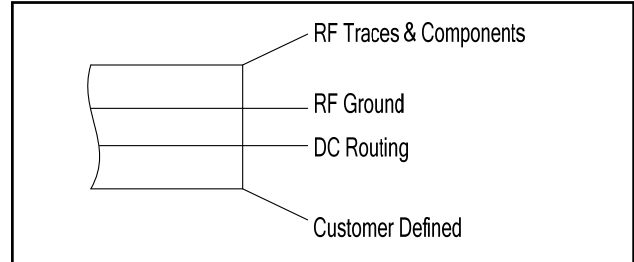

The PCB dielectric between RF traces and RF ground layers should be chosen to reduce RF discontinuities between 50 Ω lines and package pins. M/A-COM recommends an FR-4 dielectric thickness of 0.008" (0.2 mm) yielding a 50 Ω line width of 0.015" (0.38 mm). The recommended metallization thickness is 1 ounce copper.

External Circuitry Parts List ⁵

Part	Value	Purpose
C1, C2	1000 pF	Source Bypass
C3, C4	47 pF	By-Pass
C5, C6, C7	10 nF	By-Pass
L1	22 nH	Tuning
RBIAS	See note 6	Source Bias Resistor
U1	UMH9N	Dual Bipolar Transistor

- All external circuitry parts are readily available, low cost surface mount components (0.040 inches x 0.020 inches or 0.060 inches x 0.030 inches).
- RBIAS is chosen to set the desired current,
For: $I_{DD} \sim 10 \text{ mA}$, $R1 = 75 \text{ ohms}$;
 $I_{DD} \sim 20 \text{ mA}$, $R1 = 25 \text{ ohms}$;
 $I_{DD} \sim 30 \text{ mA}$, $R1 = 9 \text{ ohms}$.

External Circuitry

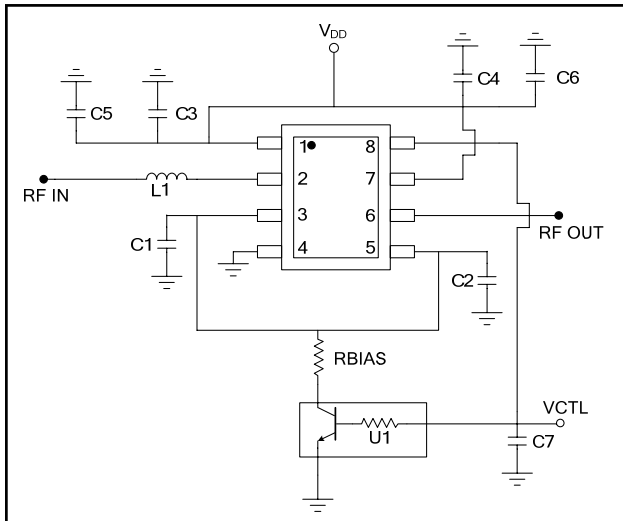

Designer's Kit AM55-0016SMB

The AM55-0016SMB Designer's Kit allows for immediate evaluation of M/A-COM's AM55-0016. The Designer's Kit includes an AM55-0016, an evaluation board and a floppy disk containing typical performance data and a DXF file of the recommended PCB layout. The evaluation board consists of the recommended external surface mount circuitry, RF connectors and a DC multi-pin connector, all mounted to a multi-layer FR-4 PCB. The AM55-0016SMB evaluation PCB is illustrated below with all functional ports labeled.

Switched Low Noise Amplifier
800 - 1000 MHz

AM55-0016
V3

Typical Performance Curves

High Gain Mode: Gain vs. Current

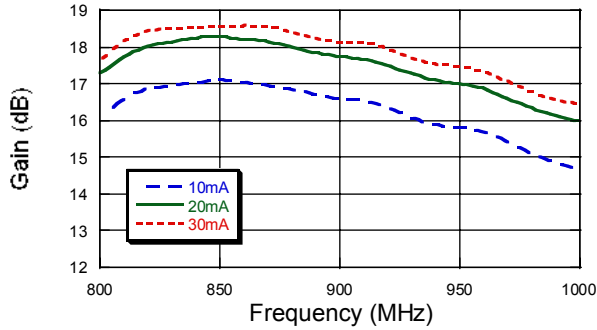

High Gain Mode: Noise Figure vs. Current

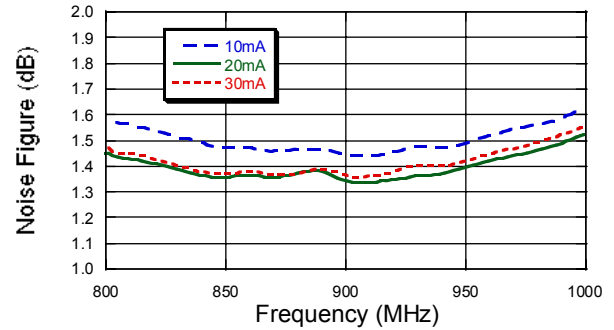

High Gain Mode: Input IP3 vs. Current

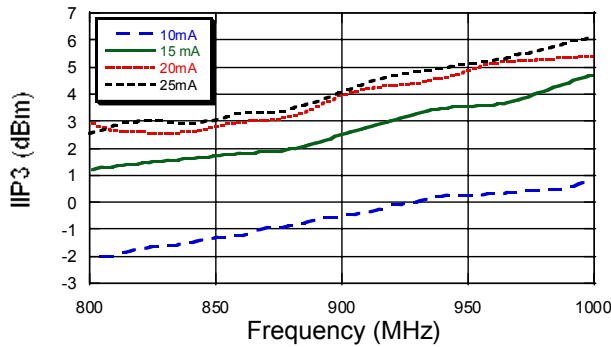

High Gain Mode: IIP3 vs. Current and Voltage

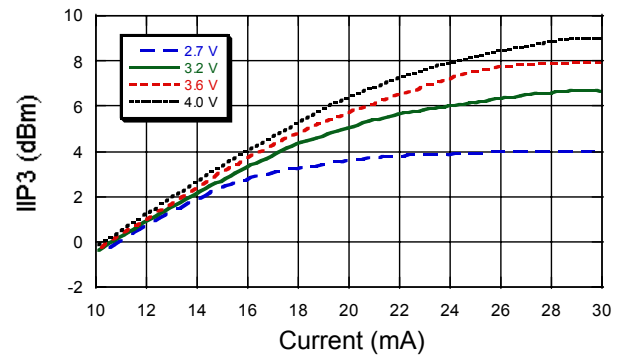

High Gain: Gain and Output Power vs. Input Power

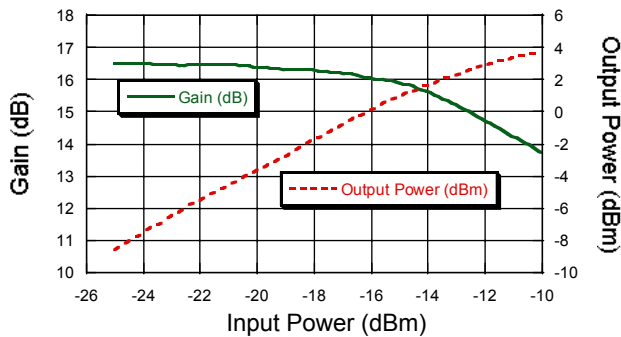

Low Gain Mode: Insertion Loss and Input IP3

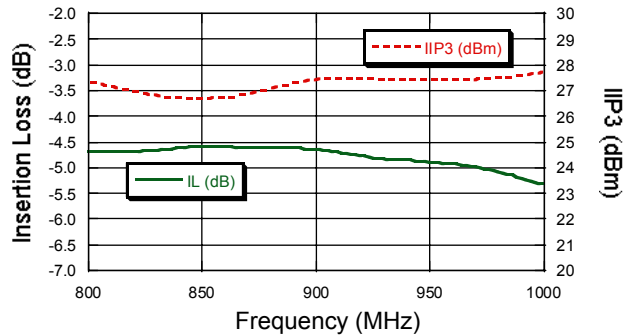

Typical Performance Curves (continued)

Input Return Loss

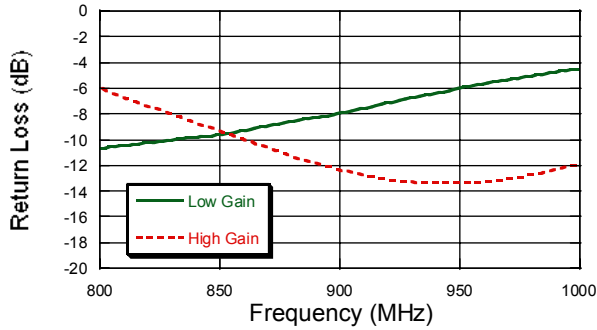

Output Return Loss

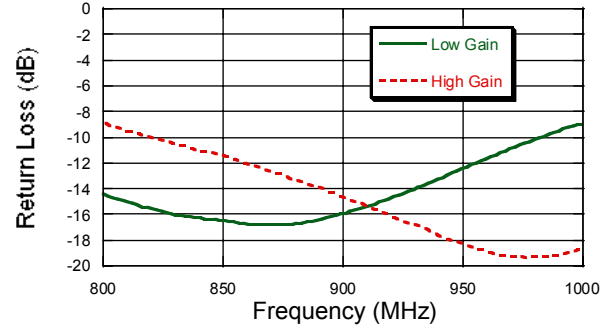

High Gain Mode: Gain vs. Temperature

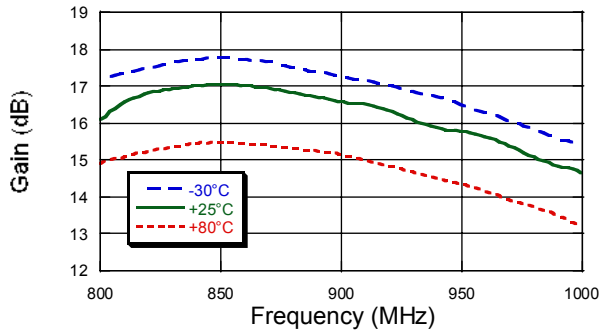

High Gain Mode: Noise Figure vs. Temperature

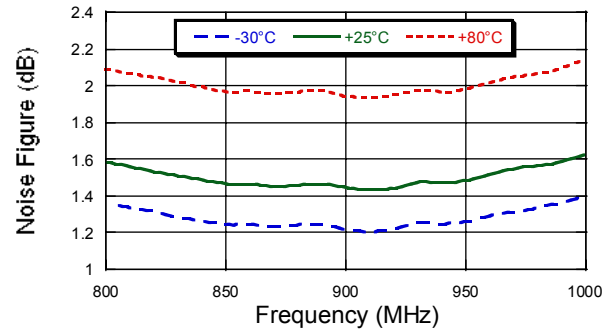

Low Gain Mode: Insertion Loss vs. Temperature

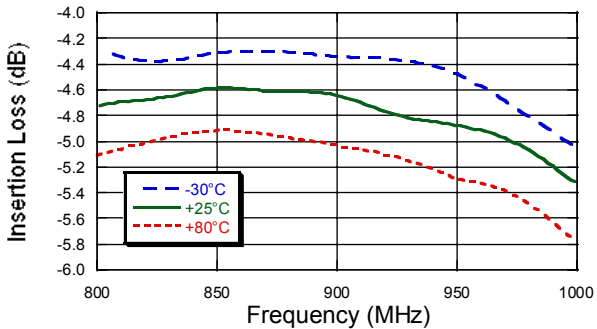

Switched Low Noise Amplifier
800 - 1000 MHz

AM55-0016
V3

MSOP-8[†]

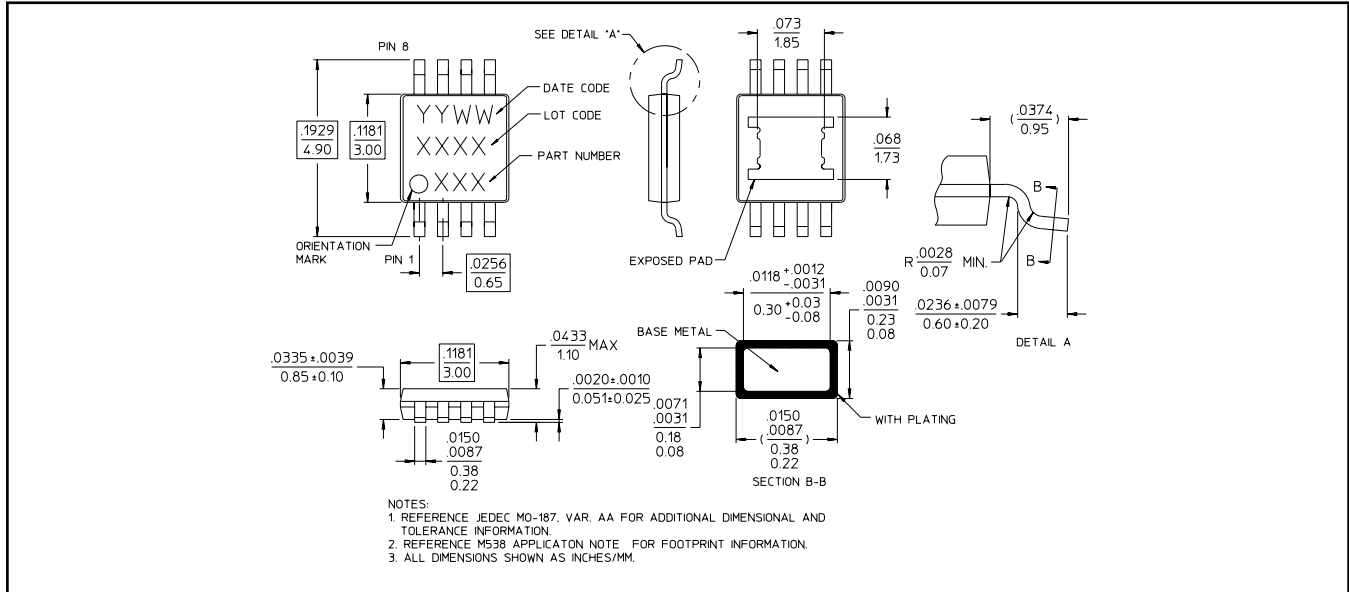

[†]Meets JEDEC moisture sensitivity level 1 requirements.