

QT-Brightek Chip LED Series
1206 Chip LED with Inner Lens
Part No.: QBLP651 Series

Product: QBLP651_series	Date: October 16, 2014	Page 1 of 14
	Version# 1.2	

Table of Contents:

Introduction	3
Electrical / Optical Characteristic (T=25 °C)	4
Absolute Maximum Rating	4
Characteristic Curves.....	8
Solder Profile	10
Labeling	12
Ordering Information	13
Revision History	14
Disclaimer	14

Introduction

Feature:

- Water clear lens (except white color)
- Yellow lens for white
- Tape and reel packaging
- Bright LED package
- InGaN technology for IB/IG/IW
- AllnGaP technology for R/AG/Y/O
- 40 °Viewing Angle (R/AG/Y/O/IB/IG)
- 165 °Viewing Angle (IW)

Description:

These 1206 LEDs have a height profile of 1.40mm. With a combination of high brightness output and a small footprint, these LEDs are ideal for status indication.

Application:

- Status indication
- Back lighting application

Certification & Compliance:

- TS16949
- ISO9001
- RoHS Compliant



Dimension:

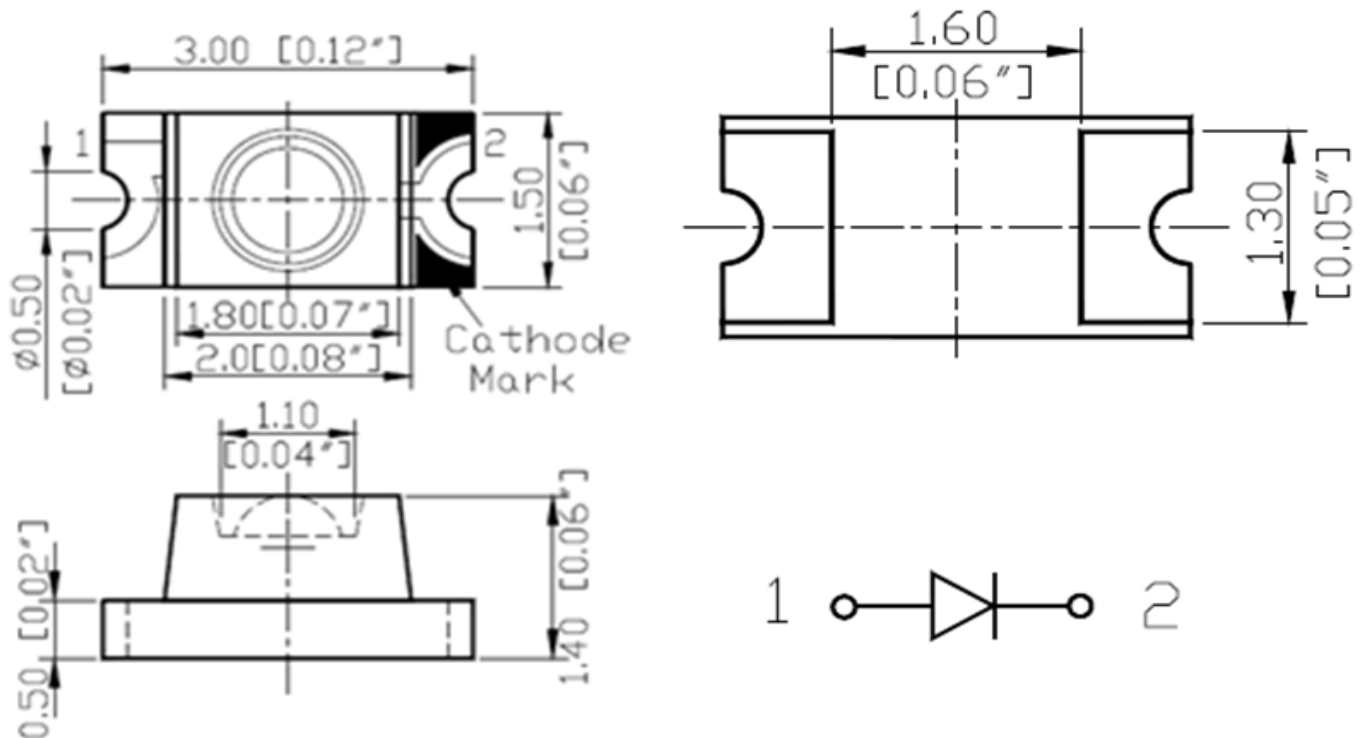

Units: mm / tolerance = +/-0.1mm

Electrical / Optical Characteristic (T=25 °C)

Product Number	Color	I _F (mA)	V _F (V)			λ _D (nm)			I _v (mcd)	
			Min	Typ.	Max	Min.	Typ.	Max.	Min.	Typ.
QBLP651-IW	White	20	2.8	3.2	3.7	x: .25 y: .24	--	x: .33 y: .34	160	320
QBLP651-IB	Blue	20	2.8	3.1	3.7	465	470	475	320	550
QBLP651-IG	True Green	20	2.8	3.4	3.7	520	525	530	1600	2700
QBLP651-R	Red	20	1.7	2.0	2.5	615	620	630	320	600
QBLP651-AG	Yellow Green	20	1.7	2.0	2.5	565	--	576	80	150
QBLP651-Y	Yellow	20	1.7	2.0	2.5	585	590	595	320	660
QBLP651-O	Orange	20	1.7	2.0	2.5	600	605	610	200	450

Absolute Maximum Rating

Material	P _d (mW)	I _F (mA)	I _{FP} (mA)*	V _R (V)	T _{OP} (°C)	T _{ST} (°C)	T _{SOL} (°C)**
AllnGaP	75	30	125	5	-40 to +80	-40 to +85	260
InGaN	111	30	125	5	-40 to +80	-40 to +85	260

*Duty 1/8 @ 1KHz

** IR Reflow for no more than 10 sec @ 260 °C

Forward Voltage V_F for AllnGaP @ I_F=20mA

Bin	Min.	Max.	Unit
□	1.7	2.5	V

Forward Voltage V_F for InGaN @ I_F=20mA

Bin	Min.	Max.	Unit
f	2.8	3.1	V
g	3.1	3.4	
h	3.4	3.7	

Luminous Intensity I_V @ $I_F=20mA$

Bin	Min.	Max.	Unit
I	80	100	mcd
J	100	125	
K	125	160	
L	160	200	
M	200	250	
N	250	320	
O	320	400	
P	400	500	
Q	500	630	
R	630	800	
S	800	1000	
T	1000	1250	
U	1250	1600	
V	1600	2000	
W	2000	2500	
X	2500	3200	
Y	3200	4000	

Dominant Wavelength λ_D for Blue @ $I_F=20mA$

Bin	Min.	Max.	Unit
G	465	467.6	nm
H	467.5	470	
I	470	472.5	
J	472.5	475	

Dominant Wavelength λ_D for True Green @ $I_F=20mA$

Bin	Min.	Max.	Unit
U	520	522.5	nm
V	522.5	525	
W	525	527.5	
X	527.5	530	

Dominant Wavelength λ_D for Red @ $I_F=20mA$

Bin	Min.	Max.	Unit
s	615	620	nm
t	620	625	
u	625	630	

Dominant Wavelength λ_D for Yellow Green @ $I_F=20\text{mA}$

Bin	Min.	Max.	Unit
h	565	568	nm
i	568	572	
j	572	576	

Dominant Wavelength λ_D for Yellow @ $I_F=20\text{mA}$

Bin	Min.	Max.	Unit
m	585	590	nm
n	590	595	

Dominant Wavelength λ_D for Orange @ $I_F=20\text{mA}$

Bin	Min.	Max.	Unit
p	600	605	nm
q	605	610	

CIE Chromaticity Table:

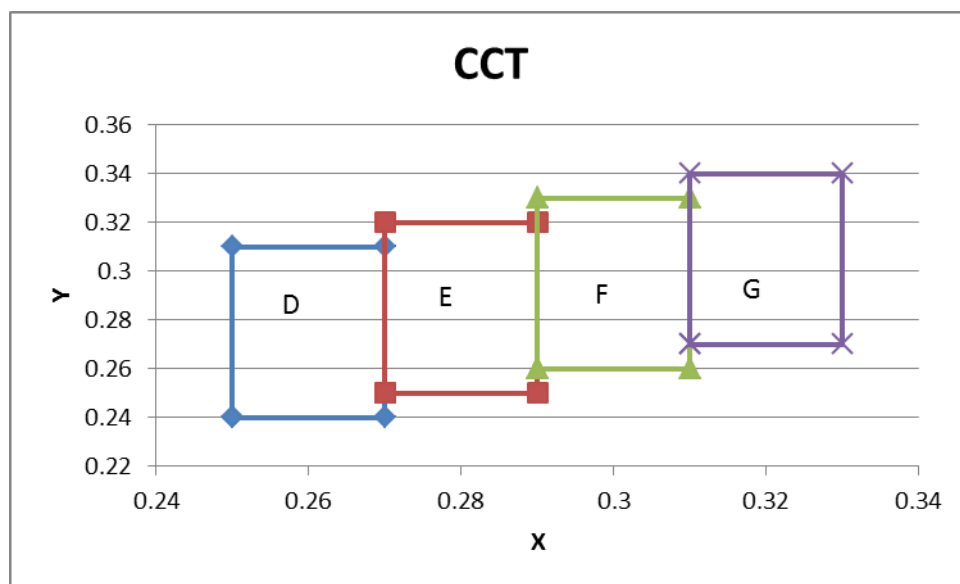

D		E		F		G	
0.25	0.24	0.27	0.25	0.29	0.26	0.31	0.27
0.25	0.31	0.27	0.32	0.29	0.33	0.31	0.34
0.27	0.31	0.29	0.32	0.31	0.33	0.33	0.34
0.27	0.24	0.29	0.25	0.31	0.26	0.33	0.27
0.25	0.24	0.27	0.25	0.29	0.26	0.31	0.27

Characteristic Curves

InGaN Technology (IW, IB, IG)

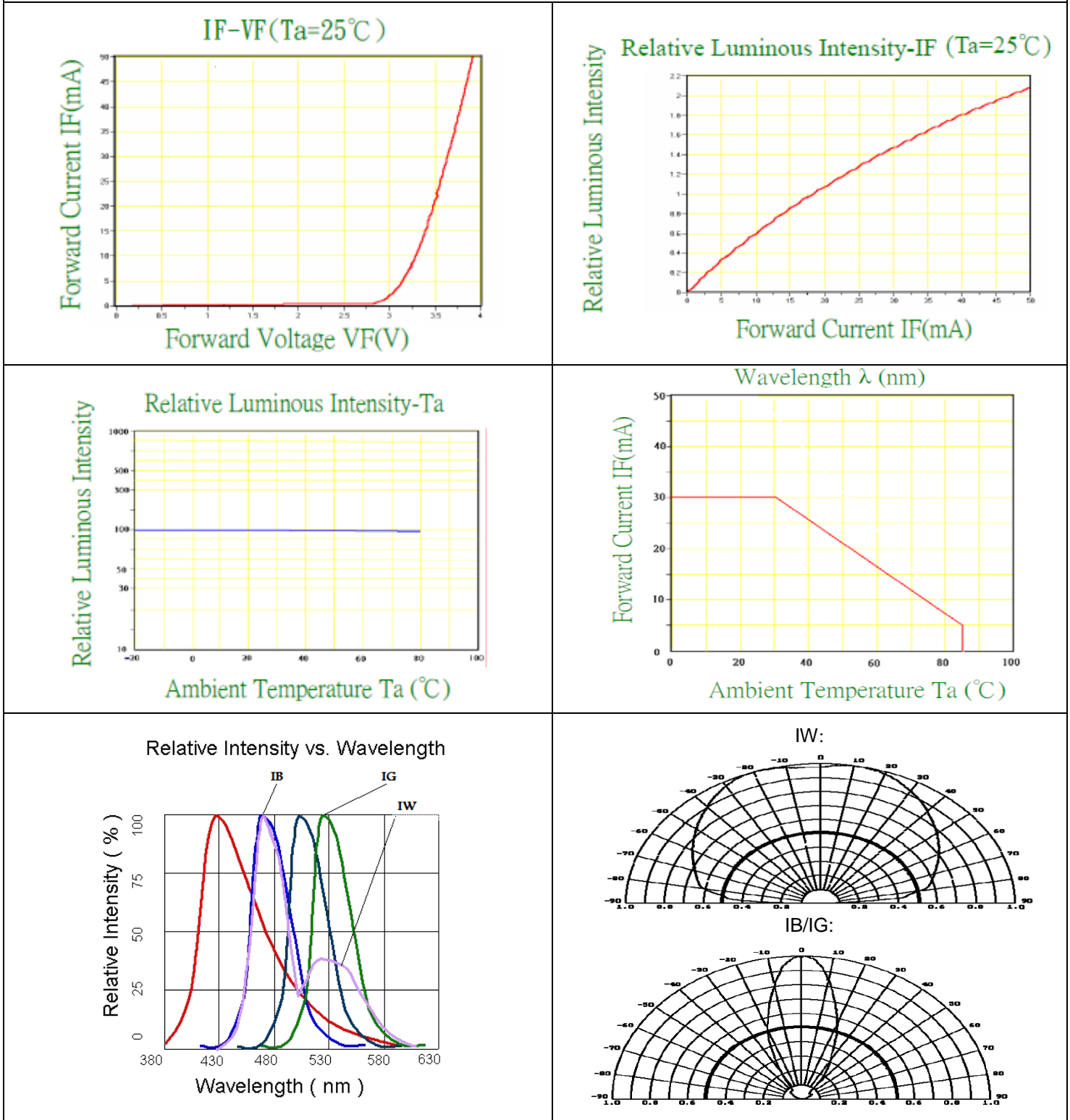

AllInGaP Technology (R/AG/Y/O)

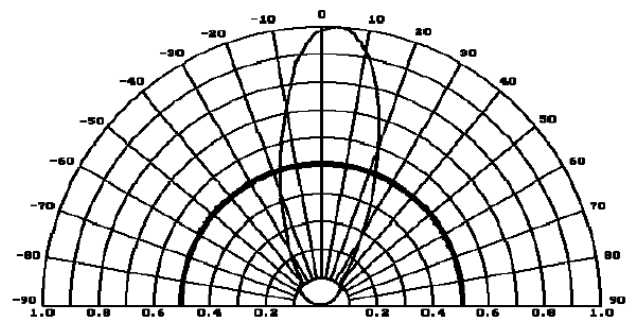
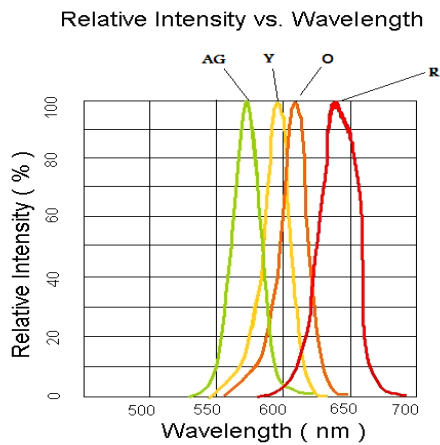
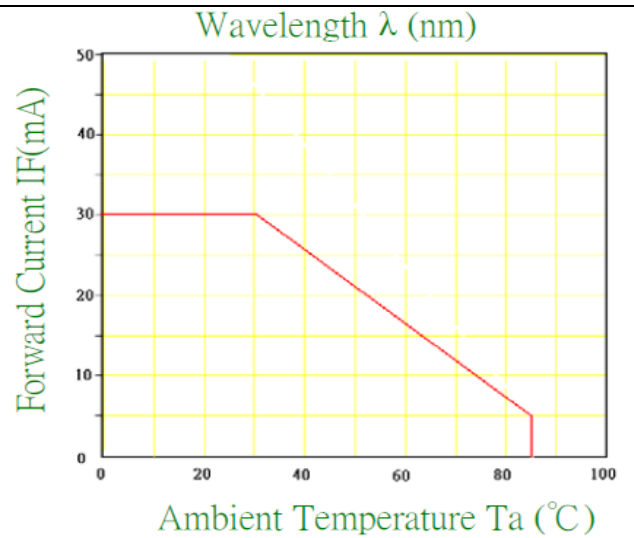
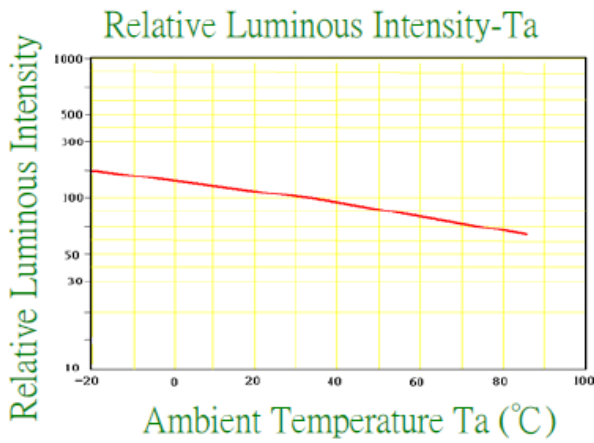
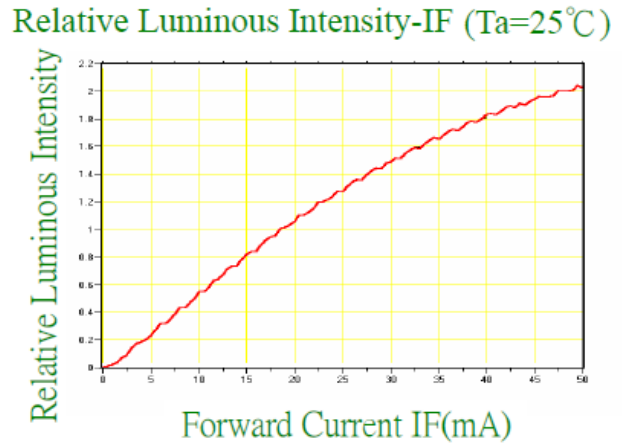
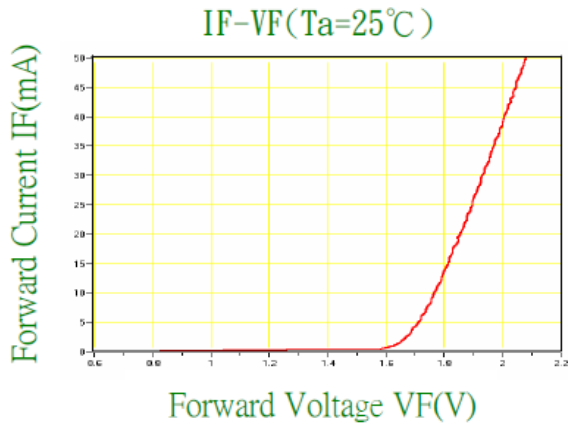

Solder Profile

Lead-Free Soldering Profile:

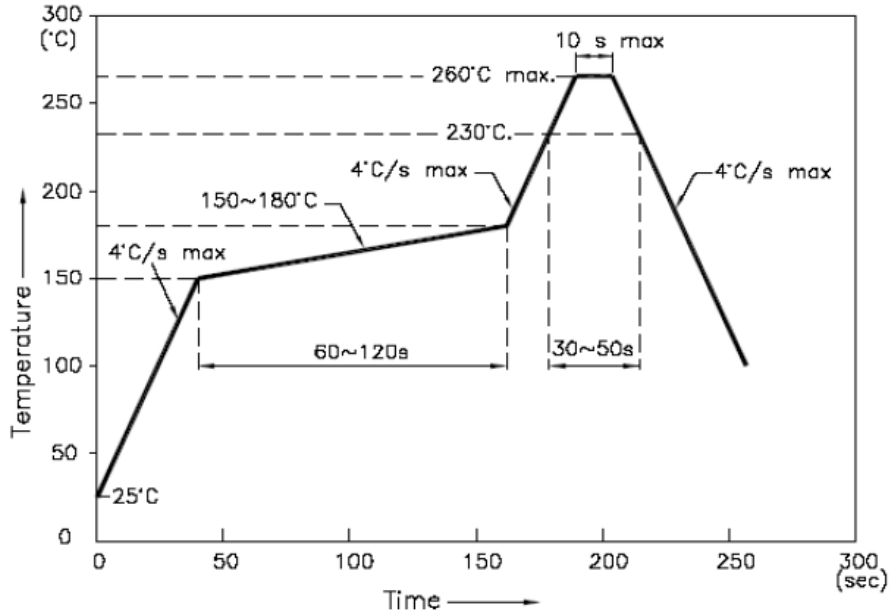

RECOMMEND PAD LAYOUT

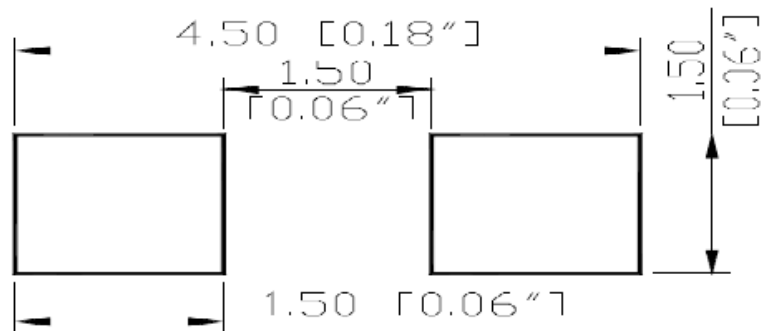

Units: mm / tolerance = +/-0.1mm

Packing

Reel Dimensions:

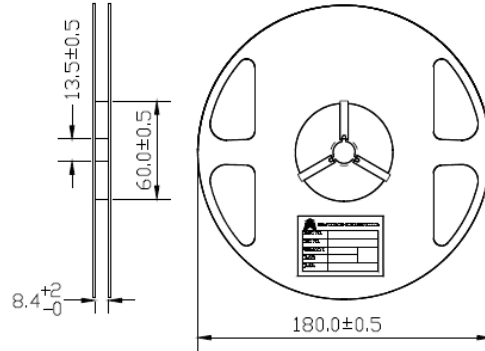

Unit: mm

Tape Dimensions:

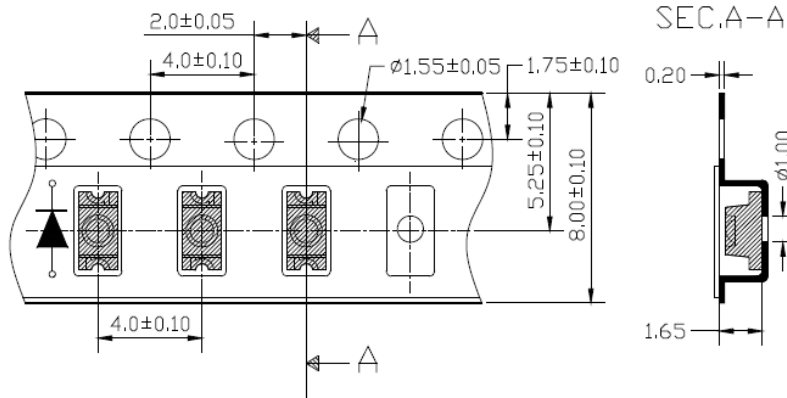

Unit: mm

Arrangement of Tape:

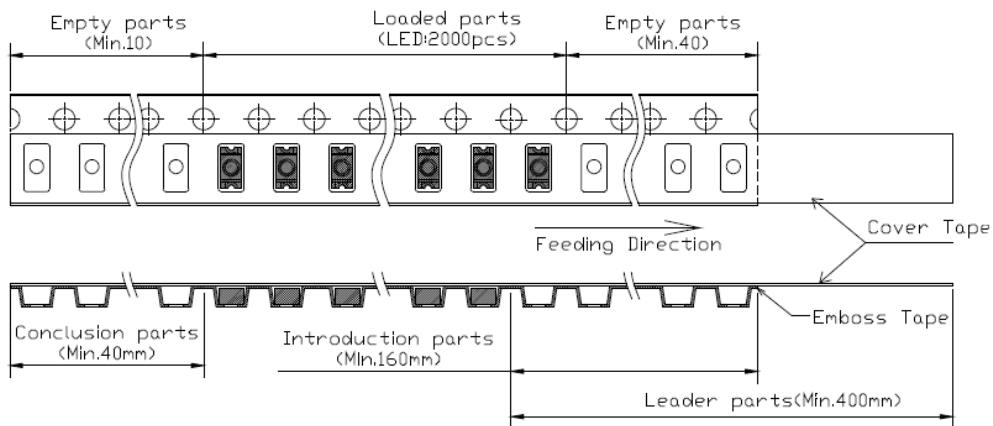

Packing specifications:

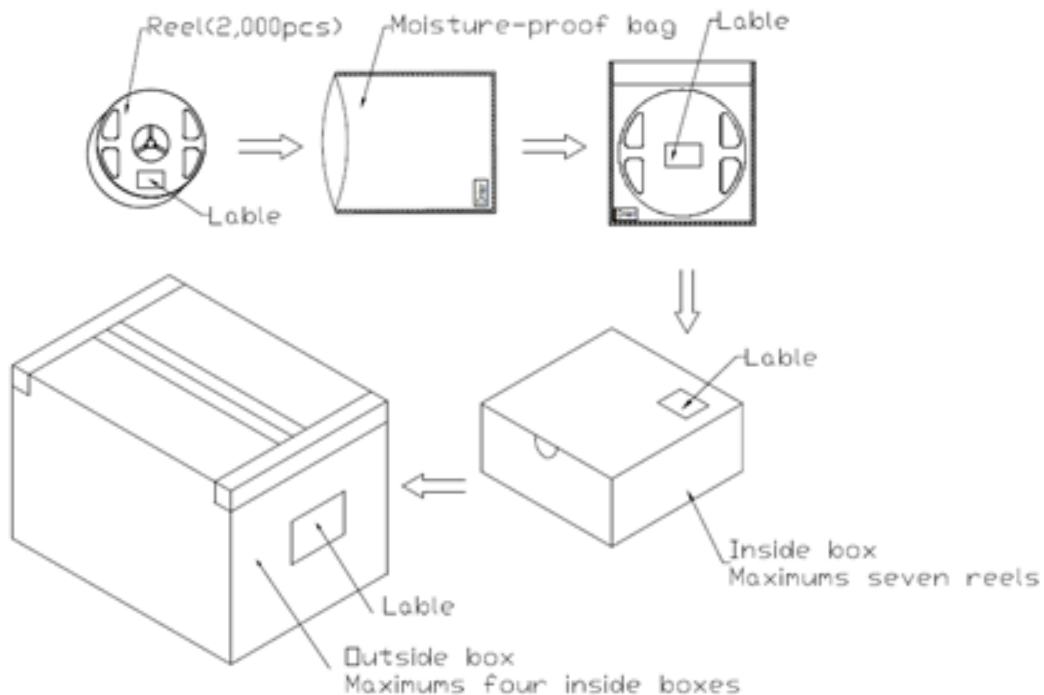

Labeling



Part No: _____

Customer P/N: _____

Item: _____

Q'ty: _____

Vf: _____

Iv: _____

WI: _____

Date: _____

Made in China

Ordering Information

Part #	Orderable Part #	Spec Range	Quantity per reel
QBLP651-IW	QBLP651-IW	$I_V=320\text{mcd typ. @ } I_F=20\text{mA}$	3,000 pcs
QBLP651-IB	QBLP651-IB	$I_V=550\text{mcd typ. @ } I_F=20\text{mA}$	3,000 pcs
QBLP651-IG	QBLP651-IG	$I_V=2700\text{mcd typ. @ } I_F=20\text{mA}$	3,000 pcs
QBLP651-R	QBLP651-R	$I_V=600\text{mcd typ. @ } I_F=20\text{mA}$	3,000 pcs
QBLP651-AG	QBLP651-AG	$I_V=150\text{mcd typ. @ } I_F=20\text{mA}$	3,000 pcs
QBLP651-Y	QBLP651-Y	$I_V=660\text{mcd typ. @ } I_F=20\text{mA}$	3,000 pcs
QBLP651-O	QBLP651-O	$I_V=450\text{mcd typ. @ } I_F=20\text{mA}$	3,000 pcs

Revision History

Description:	Revision #	Revision Date
New Release of QBLP651 Series	V1.0	03/15/2012
Information Update	V1.1	02/13/2013
Amend the packing QTY from 2k to 3k	V1.2	10/16/2014

Disclaimer

QT-BRIGHTTEK reserves the right to make changes without further notice to any products herein to improve reliability, function or design. QT-BRIGHTTEK does not assume any liability arising out of the application or use of any product or circuit described herein; neither does it convey any license under its patent rights, nor the rights of others.

Life Support Policy

QT-BRIGHTTEK's products are not authorized for use as critical components in life support devices or systems without the express written approval of QT-BRIGHTTEK. As used herein:

1. Life support devices or systems are devices or systems which, (a) are intended for surgical implant into the body, or (b) support or sustain life, and (c) whose failure to perform when properly used in accordance with instructions for use provided in the labeling, can be reasonably expected to result in a significant injury of the user.
2. A critical component in any component of a life support device or system whose failure to perform can be reasonably expected to cause the failure of the life support device or system, or to affect its safety or effectiveness.