

公司名称 Company Name	千志电子(深圳)有限公司 CHIAN CHIA ELECTRONIC(SHENZHEN)CO.,LTD				
品名 Product Name	电力型(线绕 & 波浪线绕)电阻器 power ( wirewound & ribbon wirewound ) resistor				
版本 Version	B1 版	制定日期 Enactment Date	2003 年 09 月 03 日 Sep.03 ,2003	页数 Page	4-1

## 1. 一般事项 General

### 1.1 适用 Scope

本承认书适用于千志电子(深圳)有限公司 制造之[电力型(线绕 & 波浪线绕)电阻器]。  
This specification is available for power ( wirewound & ribbon wirewound ) resistor manufactured by CCO. "ROHS"

### 1.2 形名(例) Type designation (example)

依使用产品名称、额定电力、公称电阻值、容许误差及型式而区别,其构造如下。  
The type designation shall be in the following form and as specified.

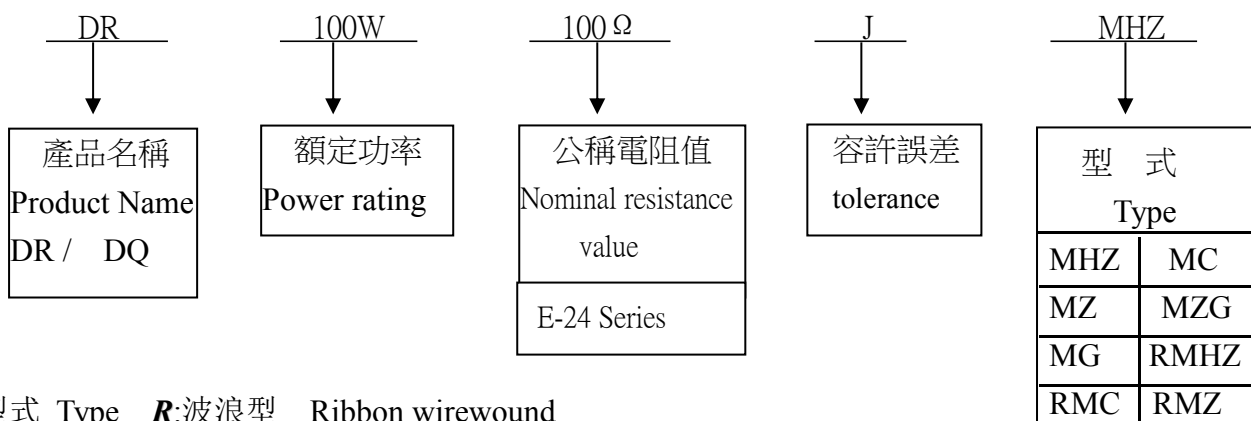

型式 Type **R**:波浪型 Ribbon wirewound

### 3 电力递减曲线 Power derating curve

线绕 Wirewound

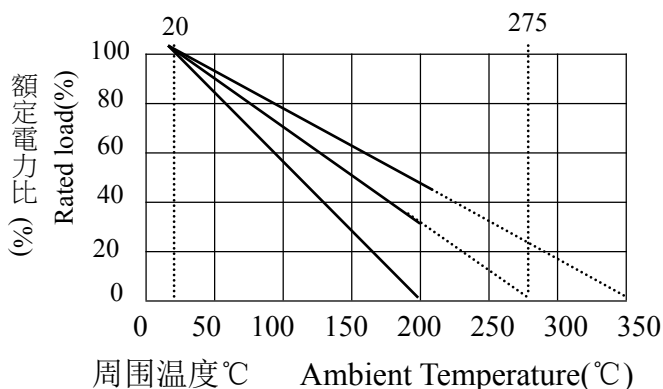

波浪线绕 Ribbon Wirewound

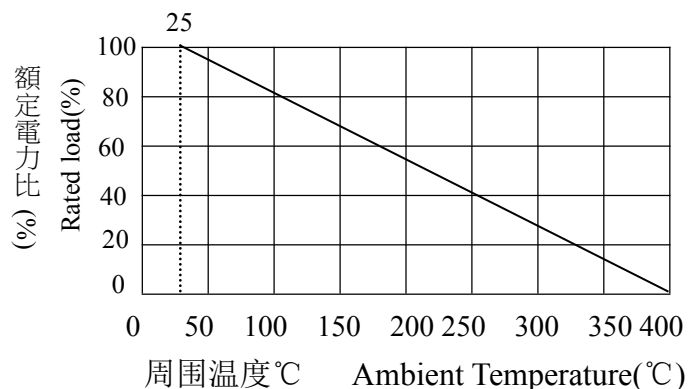

## 2. 外形寸法 External dimensions



线绕型 Wirewound



波浪型 Ribbon Wirewound

品名 Product Name	电力型 ( 线绕 & 波浪线绕 ) 电阻器 power ( wirewound & ribbon wirewound ) resistor				
版本 Version	B1 版	制定日期 Enactment Date	2003 年 09 月 03 日 Sep.03 ,2003	页数 Page	4-2

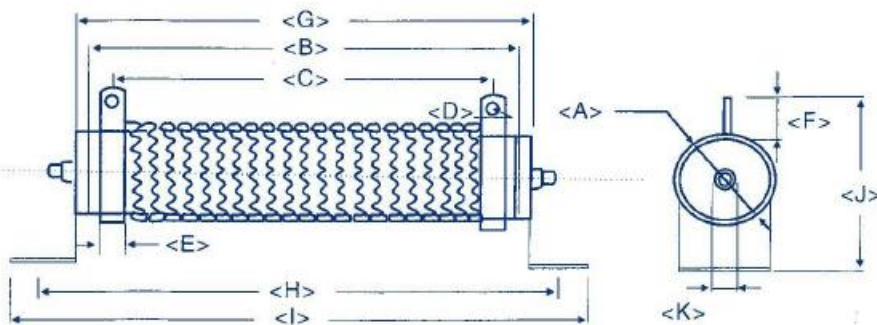

Power Rating	G	H	A	J	E	D	K
	±5	±5	±1	±3	±1	±1	±1
15W	45	65	15	40	6	3.5	4.5
20W	50	70	15	40	6	3.5	4.5
25W	50	80	20	50	6	3.5	5
30W	70	100	20	50	6	3.5	5
40W	87	115	20	50	6	3.5	5
50W	100	115	28	68	9	4.5	6
70W 分段式	230	245	28	64	8	4.5	7
80W	140	166	28	68	9	4.5	6
100W	180	195	28	68	9	4.5	6
150W	230	240	28	68	9	4.5	7
200W	280	295	28	68	9	4.5	7
250W	267	292	28	68	9	4.5	6
300W	267	300	40	90	10	4.5	6
350W	200	250	50	98	10	6	8
450W	345	365	40	90	10	5.5	7
500W	330	365	50	98	10	6	8
600W	330	365	50	98	10	6	8
700W	400	435	50	95	10	4.5	8
800W	400	435	50	95	10	4.5	8
1000W	300	320	70	135	15	8	8
1300W	420	440	70	135	15	8	8
1500W	415	435	70	135	15	8	8
2000W	510	530	70	135	15	8	8
2500W	600	620	70	135	15	8	8
3000W	600	620	70	135	15	8	8

<b>4000W</b>	<b>430</b>	<b>450</b>	<b>100</b>	<b>185</b>	<b>15</b>	<b>8</b>	<b>8</b>
<b>5000W</b>	<b>500</b>	<b>620</b>	<b>100</b>	<b>185</b>	<b>15</b>	<b>8</b>	<b>8</b>

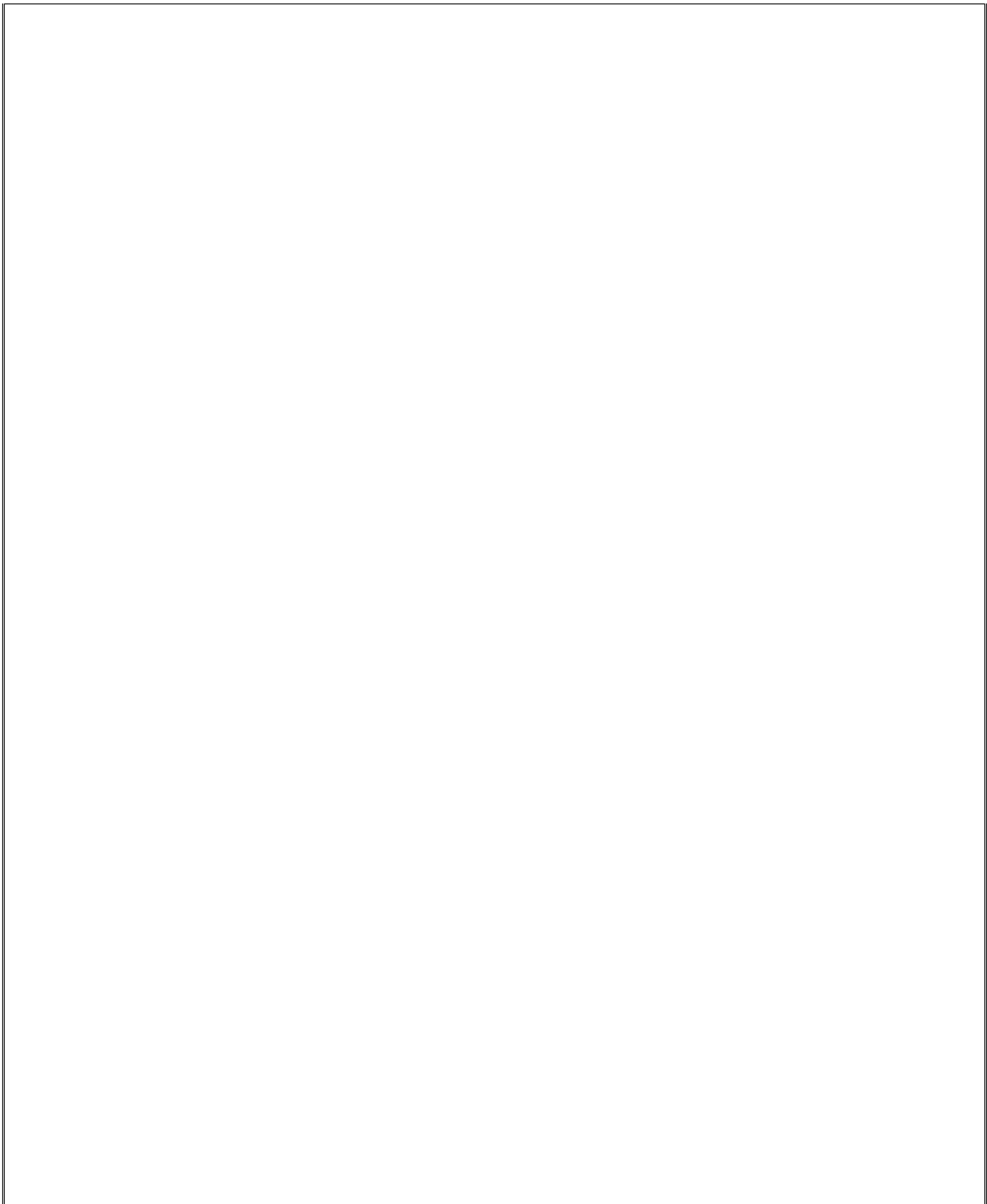

品 名 Product Name	电力型 ( 线绕 & 波浪线绕 ) 电阻器 power ( wirewound & ribbon wirewound ) resistor				
版 本 Version	B1 版	制定日期 Enactment Date	2003 年 09 月 03 日 Sep.03 ,2003	页数 Page	4-3

3.型式 Type

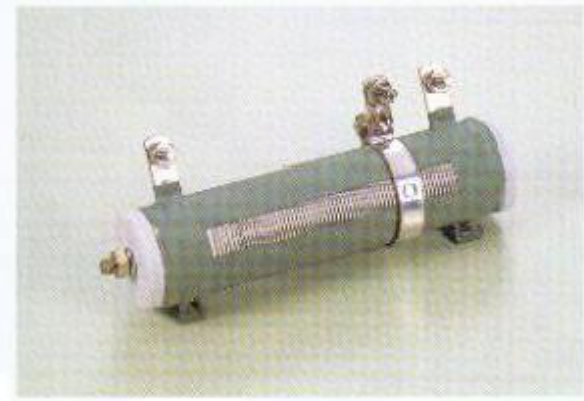

*MCG*

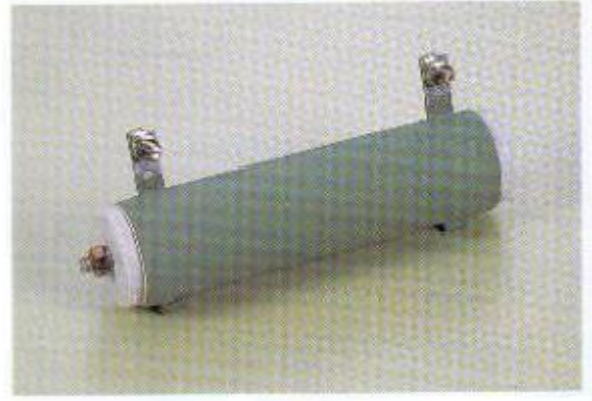

*MC*

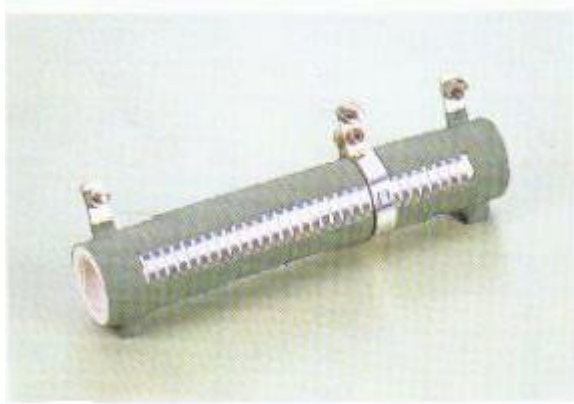

*MG*

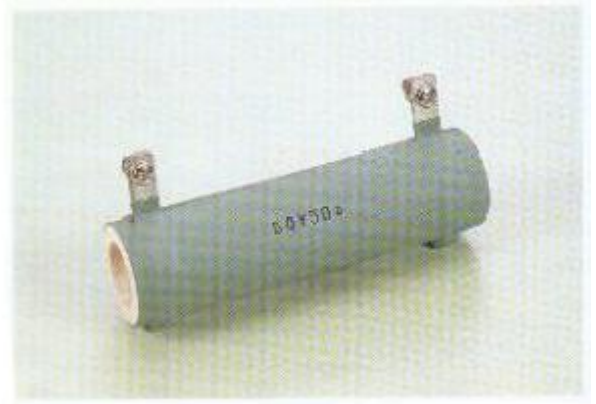

*MZ*

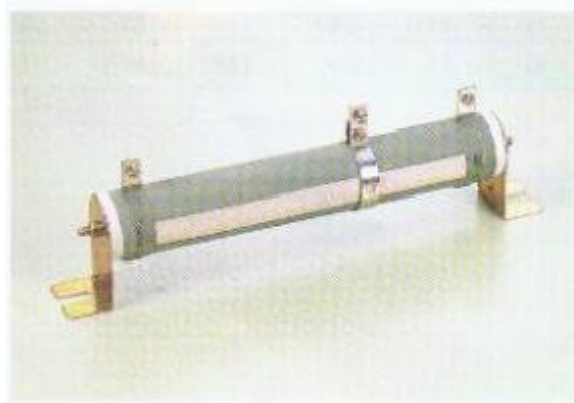

*MZG*

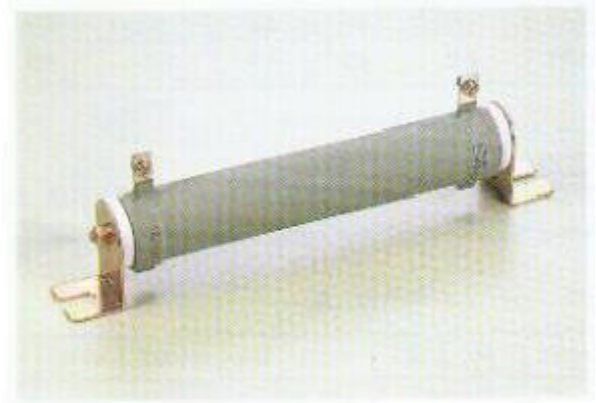

*MHZ*