

#### ELECTRICAL SPECIFICATION

PARAMETERS	SPECIFICATIONS			UNIT
Frequency	5850	5880	5925	MHz
Return Loss	-23.5	-24.2	-26.1	dB
Impedance	47 – j5.7	47.8 – j5.6	49.5 – j4.9	$\Omega$
VSWR	1.14	1.13	1.10	-

#### FREQUENCY CHARACTERISTICS

##### RETURN LOSS

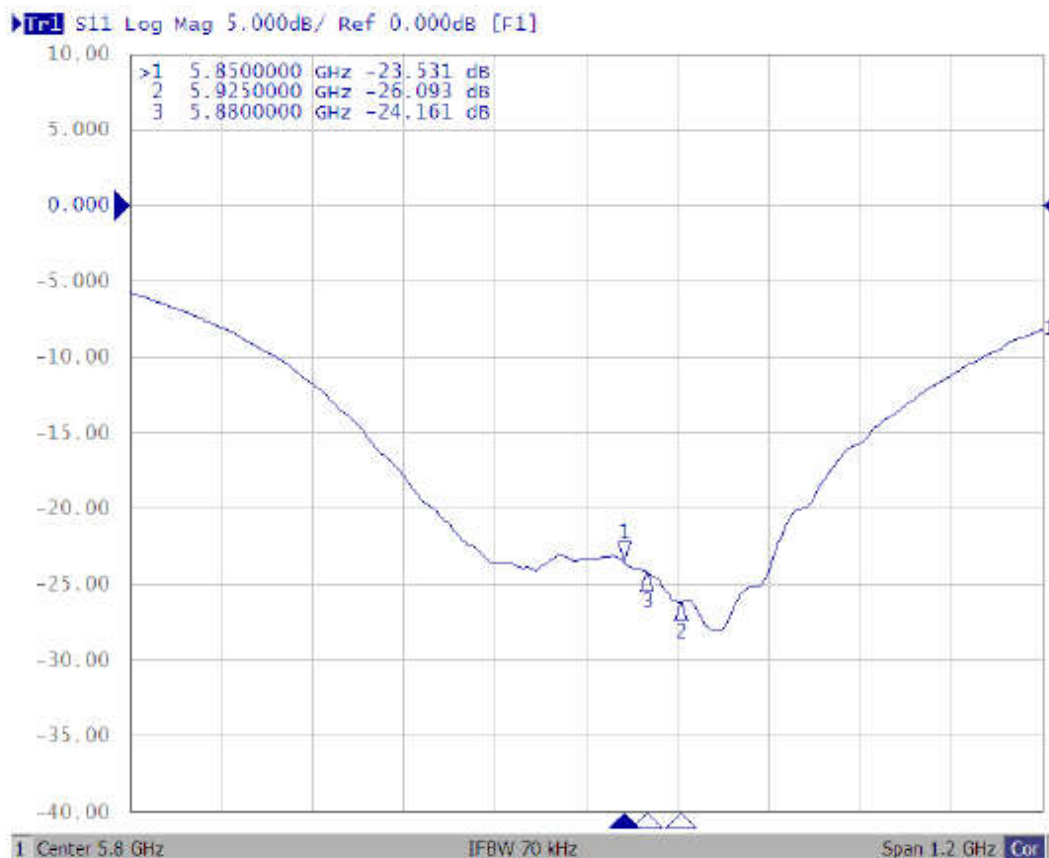

#### SMITH CHART

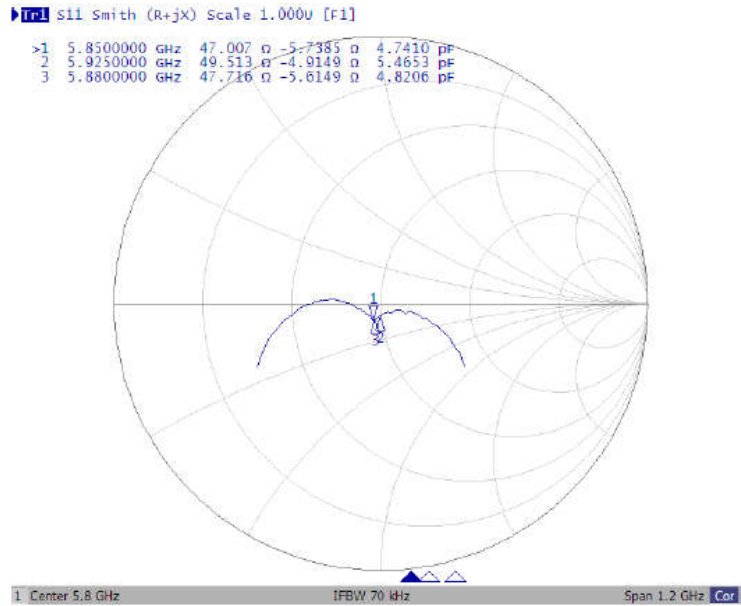

#### VSWR

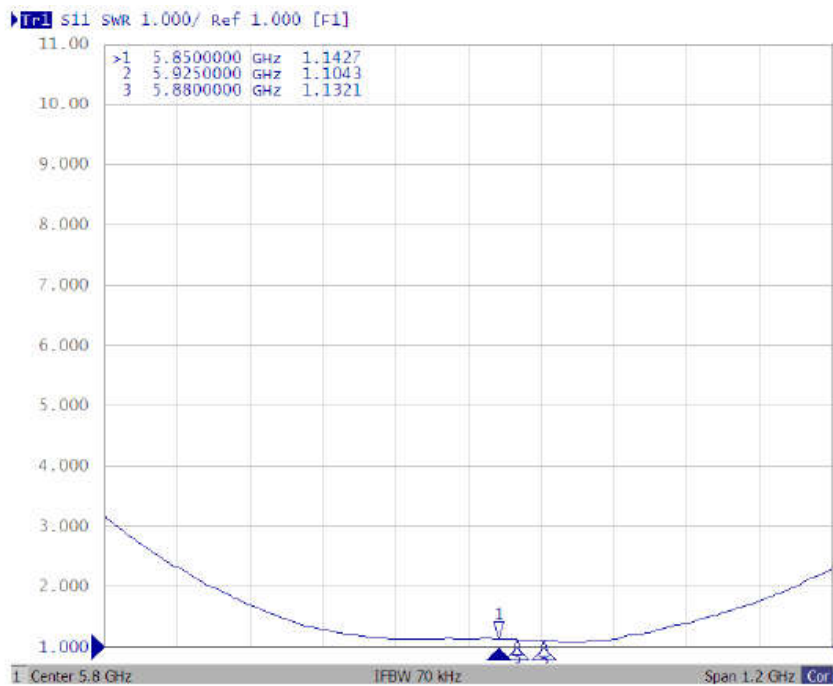

#### ■ RADIATION PATTERNS

##### GAIN PATTERN (5850 MHz)

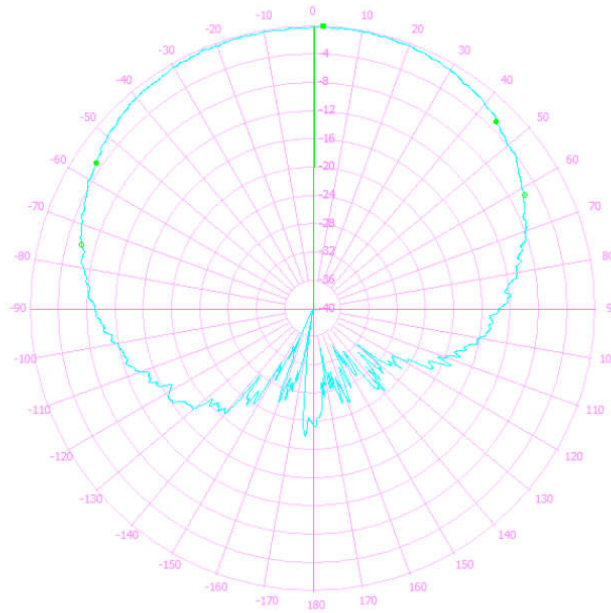

XZ Plane (PHI=0° )

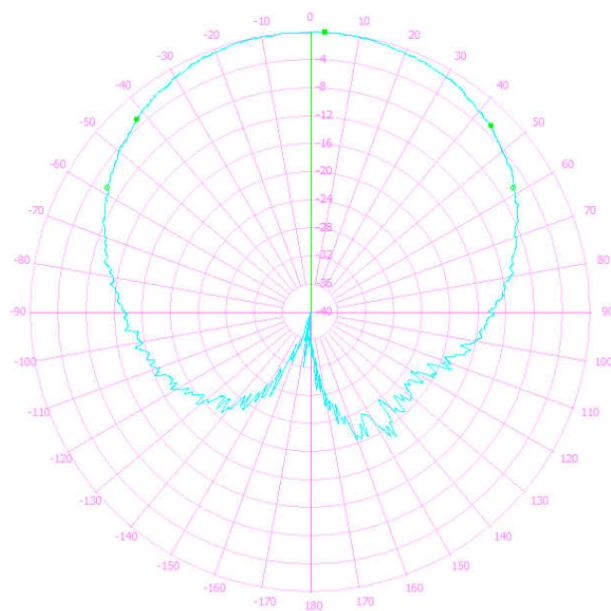

YZ Plane (PHI=90° )

5850MHz	Peak Gain	Zenith Gain
XZ	6.83	6.70
YZ	7.41	7.29

Gain RHCP (Unit: dBic)

#### GAIN PATTERN (5880 MHz)

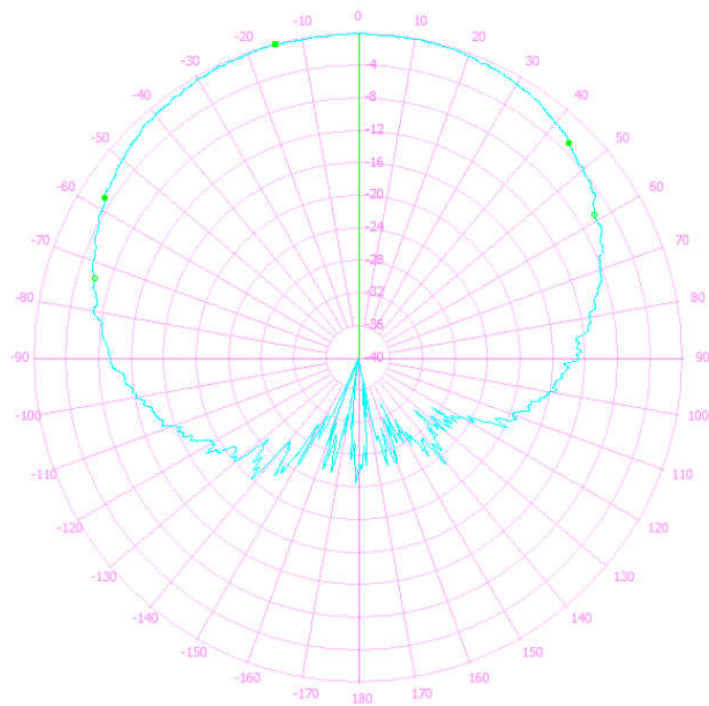

XZ Plane (PHI=0° )

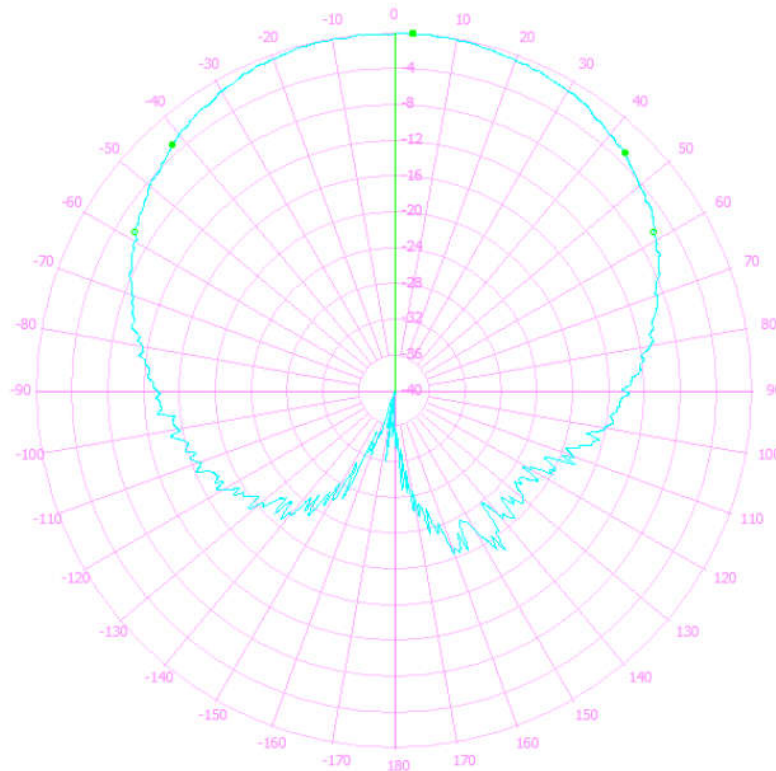

YZ Plane (PHI=90° )

5880MHz	Peak Gain	Zenith Gain
XZ	6.96	6.83
YZ	7.66	7.55

Gain RHCP (Unit: dBic)

#### GAIN PATTERN (5925 MHz)

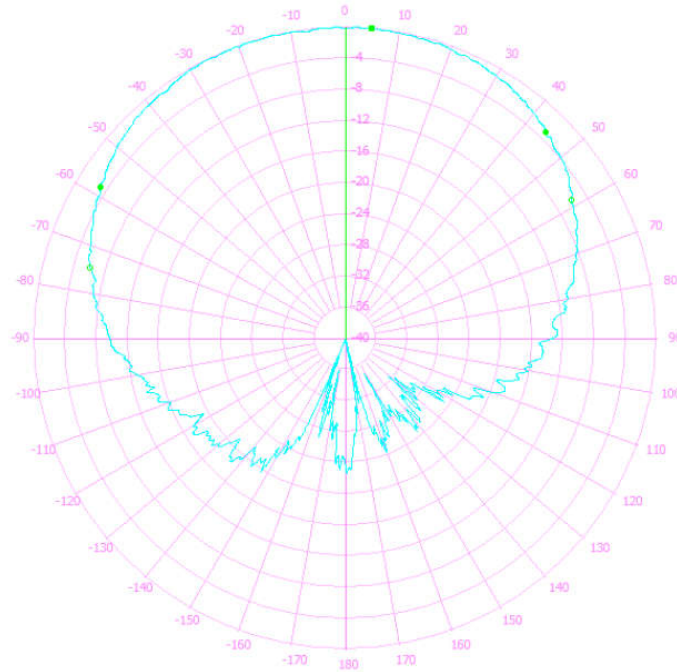

XZ Plane (PHI=0° )

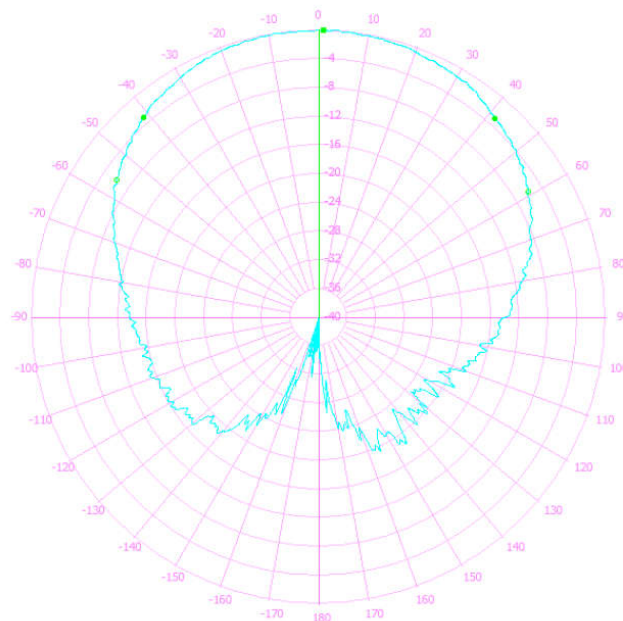

YZ Plane (PHI=90° )

5925MHz	Peak Gain	Zenith Gain
XZ	6.76	6.56
YZ	7.66	7.63

Gain RHCP (Unit: dBic)

#### AXIAL RATIO PATTERN (5850 MHz)

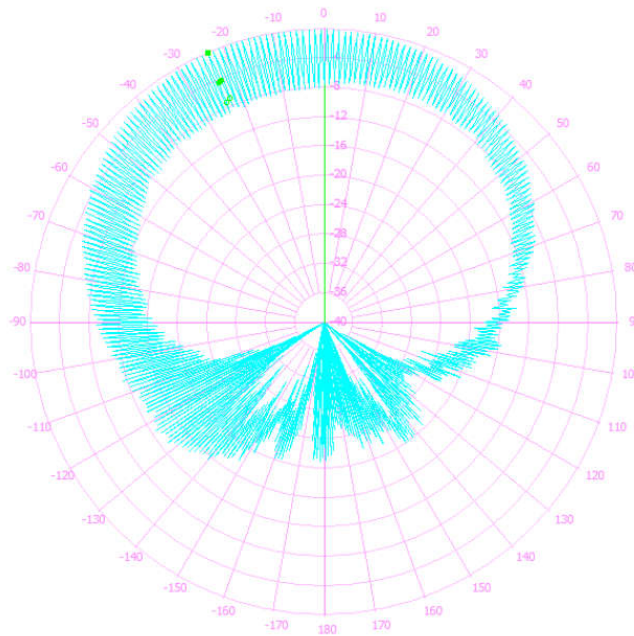

5850MHz	Axial Ratio
XZ / Zenith	7.5

Unit: dB

#### AXIAL RATIO PATTERN (5880 MHz)

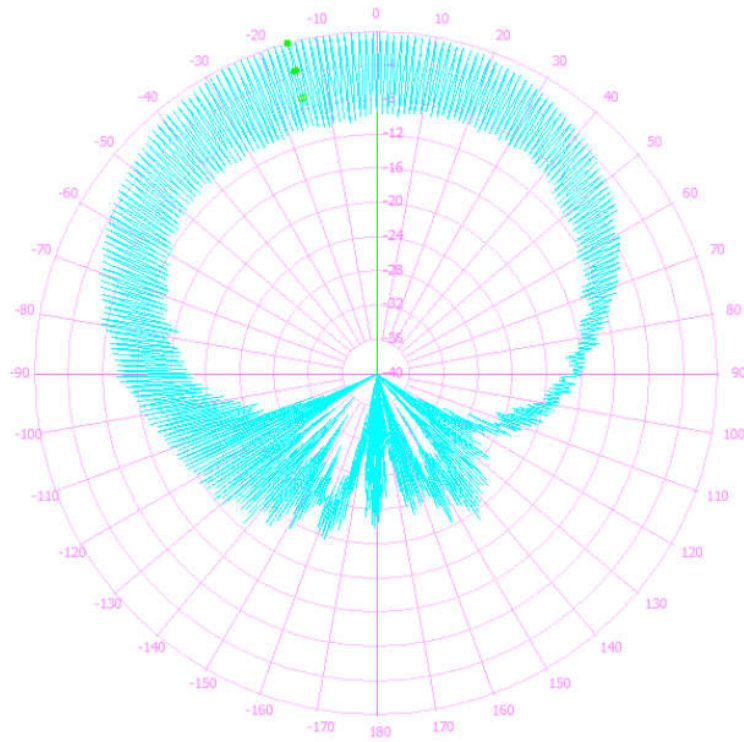

5880MHz	Axial Ratio
XZ / zenith	9.2

Unit: dB



#### AXIAL RATIO PATTERN (5925 MHz)

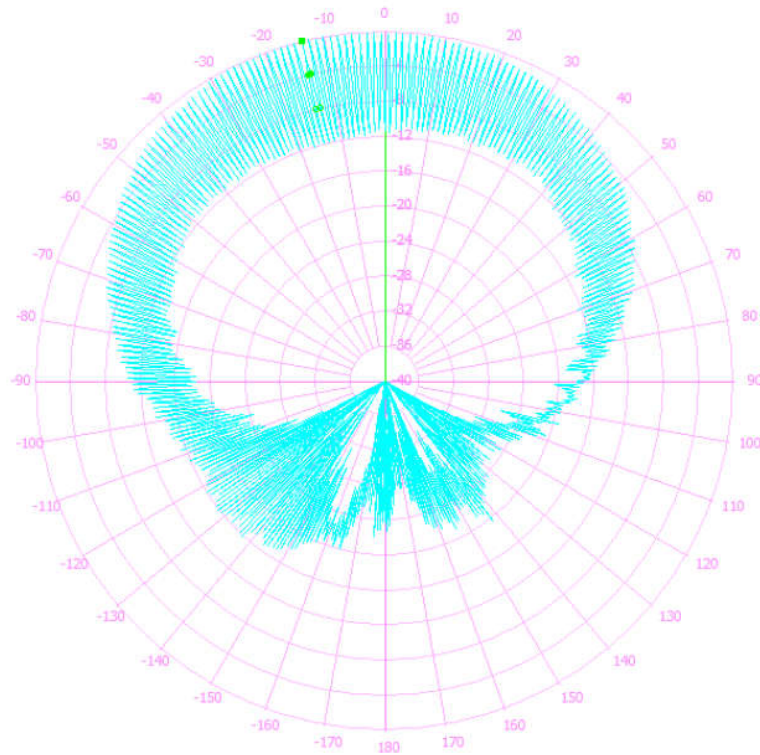

5925MHz	Axial Ratio
XZ / zenith	11.2

Unit: dB

#### ■ DIMENSION

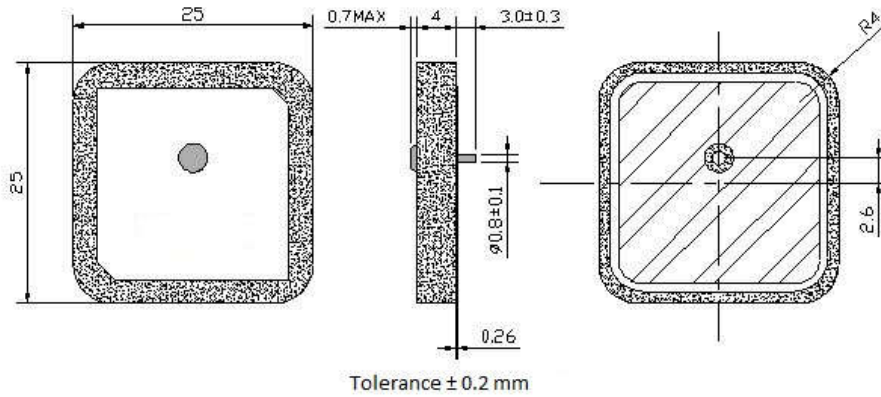

May, 2016