

N-channel 600 V, 0.037 Ω typ., 66 A MDmesh™ DM2 Power MOSFET in a TO-247 package

Datasheet - production data

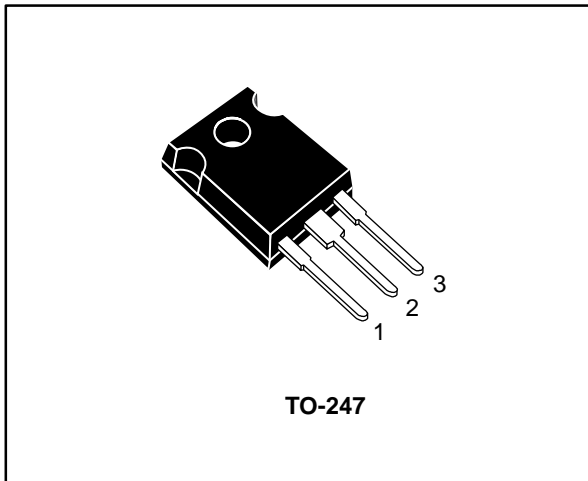
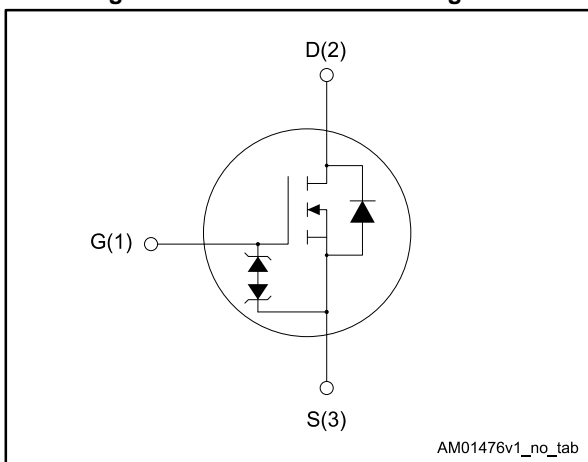

Figure 1: Internal schematic diagram



Features

Order code	V _{DS}	R _{DS(on)} max.	I _D	P _{TOT}
STW70N60DM2	600 V	0.042 Ω	66 A	446 W

- Fast-recovery body diode
- Extremely low gate charge and input capacitance
- Low on-resistance
- 100% avalanche tested
- Extremely high dv/dt ruggedness
- Zener-protected

Applications

- Switching applications

Description

This high voltage N-channel Power MOSFET is part of the MDmesh™ DM2 fast recovery diode series. It offers very low recovery charge (Q_{rr}) and time (t_{rr}) combined with low $R_{DS(on)}$, rendering it suitable for the most demanding high efficiency converters and ideal for bridge topologies and ZVS phase-shift converters.

Table 1: Device summary

Order code	Marking	Package	Packing
STW70N60DM2	70N60DM2	TO-247	Tube

Contents

1	Electrical ratings	3
2	Electrical characteristics	4
	2.1 Electrical characteristics (curves).....	6
3	Test circuits	8
4	Package information	9
	4.1 TO-247 package information.....	9
5	Revision history	11

1 Electrical ratings

Table 2: Absolute maximum ratings

Symbol	Parameter	Value	Unit
V_{GS}	Gate-source voltage	± 25	V
I_D	Drain current (continuous) at $T_{case} = 25\text{ }^\circ\text{C}$	66	A
	Drain current (continuous) at $T_{case} = 100\text{ }^\circ\text{C}$	42	
$I_{DM}^{(1)}$	Drain current (pulsed)	264	A
P_{TOT}	Total dissipation at $T_{case} = 25\text{ }^\circ\text{C}$	446	W
$dv/dt^{(2)}$	Peak diode recovery voltage slope	50	V/ns
$dv/dt^{(3)}$	MOSFET dv/dt ruggedness	50	
T_{stg}	Storage temperature	-55 to 150	$^\circ\text{C}$
T_j	Operating junction temperature		

Notes:

(1) Pulse width is limited by safe operating area.

(2) $I_{SD} \leq 66\text{ A}$, $di/dt=900\text{ A}/\mu\text{s}$; $V_{DS\text{ peak}} < V_{(BR)DSS}$, $V_{DD} = 400\text{ V}$.

(3) $V_{DS} \leq 480\text{ V}$.

Table 3: Thermal data

Symbol	Parameter	Value	Unit
$R_{thj-case}$	Thermal resistance junction-case	0.28	$^\circ\text{C}/\text{W}$
$R_{thj-amb}$	Thermal resistance junction-ambient	50	

Table 4: Avalanche characteristics

Symbol	Parameter	Value	Unit
I_{AR}	Avalanche current, repetitive or not repetitive (Pulse width limited by T_{jmax})	10	A
E_{AS}	Single pulse avalanche energy (starting $T_j = 25\text{ }^\circ\text{C}$, $I_D = I_{AR}$, $V_{DD} = 50\text{ V}$)	1500	mJ

2 Electrical characteristics

($T_{\text{case}} = 25\text{ °C}$ unless otherwise specified)

Table 5: Static

Symbol	Parameter	Test conditions	Min.	Typ.	Max.	Unit
$V_{(BR)DSS}$	Drain-source breakdown voltage	$V_{GS} = 0\text{ V}$, $I_D = 1\text{ mA}$	600			V
I_{DSS}	Zero gate voltage drain current	$V_{GS} = 0\text{ V}$, $V_{DS} = 600\text{ V}$			10	μA
		$V_{GS} = 0\text{ V}$, $V_{DS} = 600\text{ V}$, $T_{\text{case}} = 125\text{ °C}$			100	
I_{GSS}	Gate-body leakage current	$V_{DS} = 0\text{ V}$, $V_{GS} = \pm 25\text{ V}$			± 5	μA
$V_{GS(th)}$	Gate threshold voltage	$V_{DS} = V_{GS}$, $I_D = 250\text{ }\mu\text{A}$	3	4	5	V
$R_{DS(on)}$	Static drain-source on-resistance	$V_{GS} = 10\text{ V}$, $I_D = 33\text{ A}$		0.037	0.042	Ω

Table 6: Dynamic

Symbol	Parameter	Test conditions	Min.	Typ.	Max.	Unit
C_{iss}	Input capacitance	$V_{DS} = 100\text{ V}$, $f = 1\text{ MHz}$, $I_D = 0\text{ A}$	-	5508	-	μF
C_{oss}	Output capacitance		-	241	-	
C_{riss}	Reverse transfer capacitance		-	2.8	-	
$C_{oss\text{ eq.}}^{(1)}$	Equivalent output capacitance	$V_{DS} = 0\text{ to }480\text{ V}$, $V_{GS} = 0\text{ V}$	-	470	-	μF
R_G	Intrinsic gate resistance	$f = 1\text{ MHz}$, $I_D = 0\text{ A}$	-	2	-	Ω
Q_g	Total gate charge	$V_{DD} = 480\text{ V}$, $I_D = 66\text{ A}$, $V_{GS} = 10\text{ V}$ (see Figure 15: "Test circuit for gate charge behavior")	-	121	-	nC
Q_{gs}	Gate-source charge		-	26	-	
Q_{gd}	Gate-drain charge		-	61	-	

Notes:

⁽¹⁾ $C_{oss\text{ eq.}}$ is defined as a constant equivalent capacitance giving the same charging time as C_{oss} when V_{DS} increases from 0 to 80% V_{DSS} .

Table 7: Switching times

Symbol	Parameter	Test conditions	Min.	Typ.	Max.	Unit
$t_{d(on)}$	Turn-on delay time	$V_{DD} = 300\text{ V}$, $I_D = 33\text{ A}$ $R_G = 4.7\text{ }\Omega$, $V_{GS} = 10\text{ V}$ (see Figure 14: "Test circuit for resistive load switching times" and)	-	32	-	ns
t_r	Rise time		-	67	-	
$t_{d(off)}$	Turn-off delay time		-	112	-	
t_f	Fall time		-	10.4	-	

Table 8: Source-drain diode

Symbol	Parameter	Test conditions	Min.	Typ.	Max.	Unit
I_{SD}	Source-drain current		-		66	A
$I_{SDM}^{(1)}$	Source-drain current (pulsed)		-		264	A
$V_{SD}^{(2)}$	Forward on voltage	$V_{GS} = 0 \text{ V}$, $I_{SD} = 66 \text{ A}$	-		1.6	V
t_{rr}	Reverse recovery time	$I_{SD} = 66 \text{ A}$, $di/dt = 100 \text{ A}/\mu\text{s}$, $V_{DD} = 60 \text{ V}$ (see Figure 16 : "Test circuit for inductive load switching and diode recovery times")	-	150		ns
Q_{rr}	Reverse recovery charge		-	0.75		μC
I_{RRM}	Reverse recovery current		-	10.5		A
t_{rr}	Reverse recovery time	$I_{SD} = 66 \text{ A}$, $di/dt = 100 \text{ A}/\mu\text{s}$, $V_{DD} = 60 \text{ V}$, $T_j = 150 \text{ }^\circ\text{C}$ (see Figure 16 : "Test circuit for inductive load switching and diode recovery times")	-	250		ns
Q_{rr}	Reverse recovery charge		-	2.5		μC
I_{RRM}	Reverse recovery current		-	20.7		A

Notes:

- (1) Pulse width is limited by safe operating area.
(2) Pulse test: pulse duration = 300 μs , duty cycle 1.5%.

2.1 Electrical characteristics (curves)

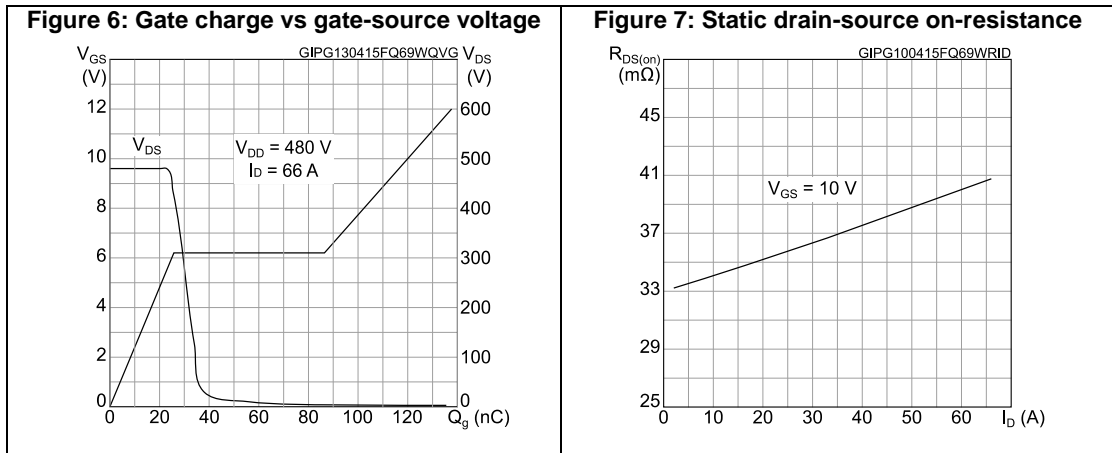
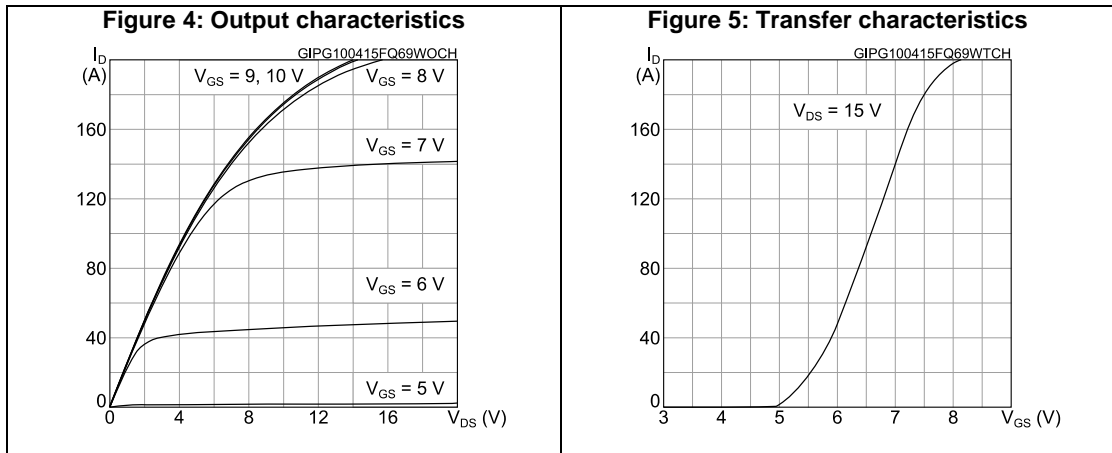
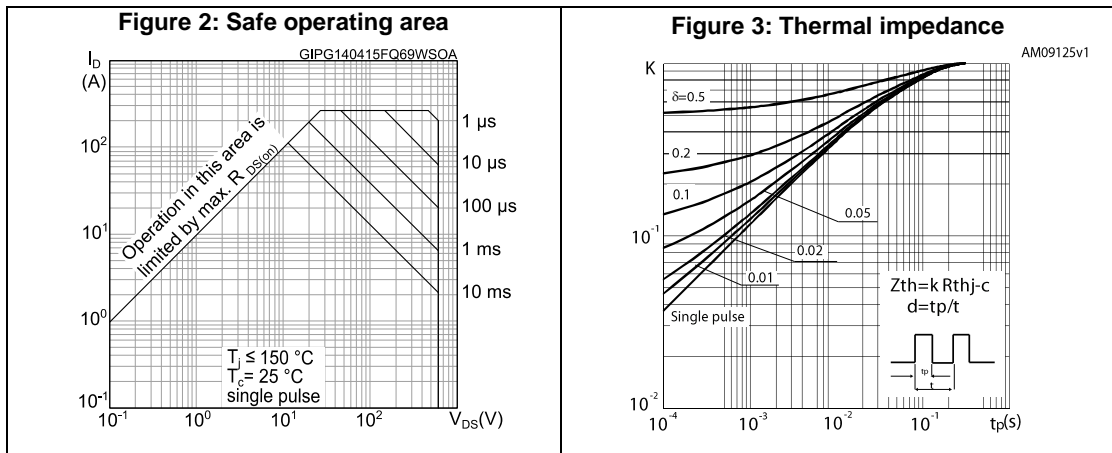

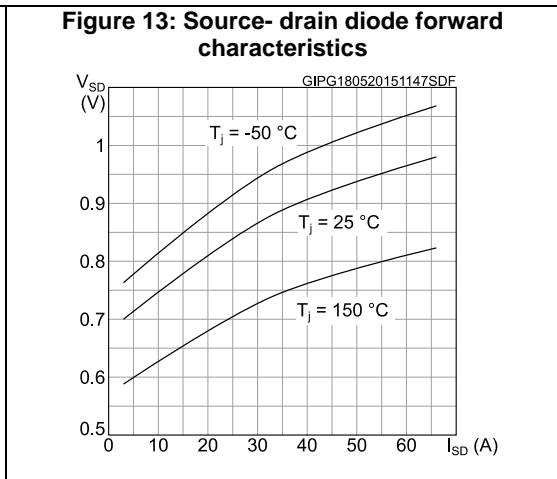
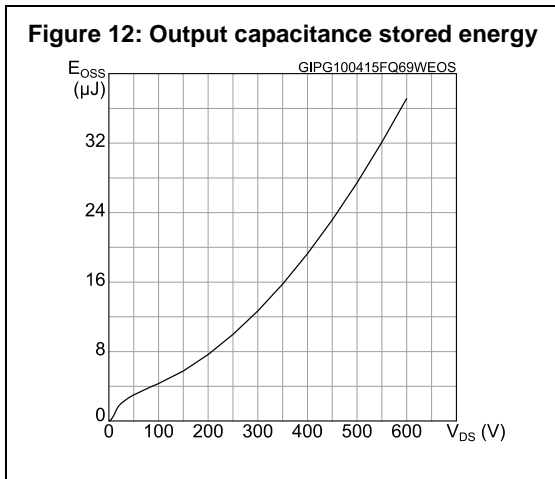
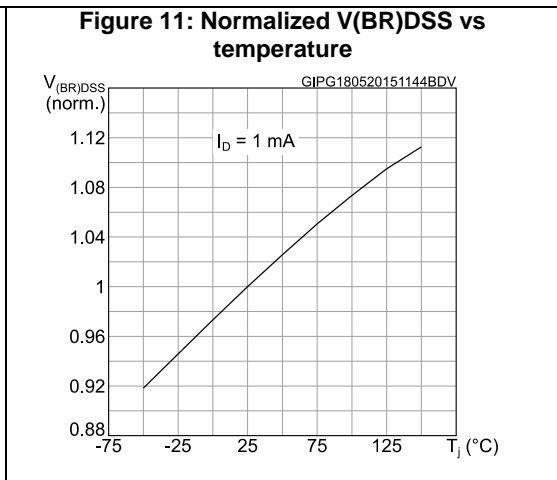
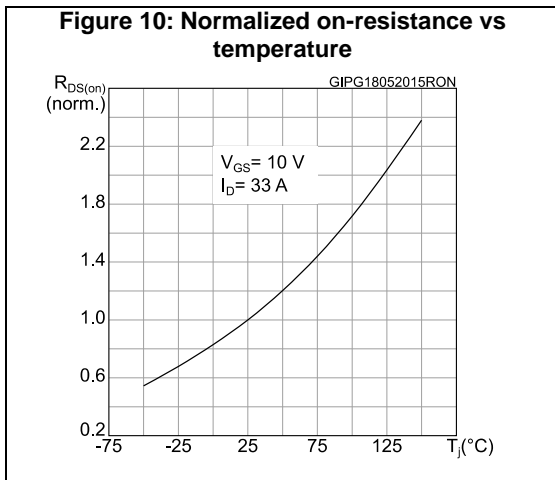
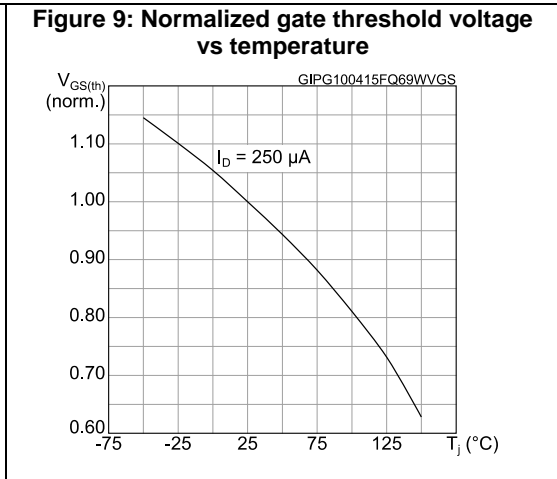
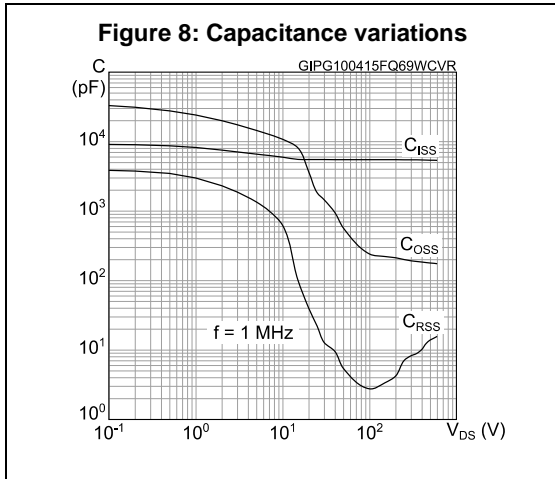

3 Test circuits

Figure 14: Test circuit for resistive load switching times

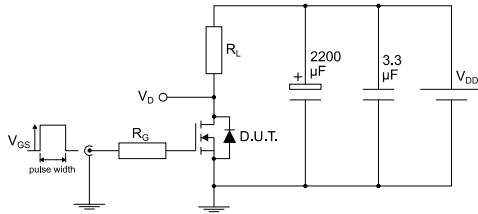

AM01468v1

Figure 15: Test circuit for gate charge behavior

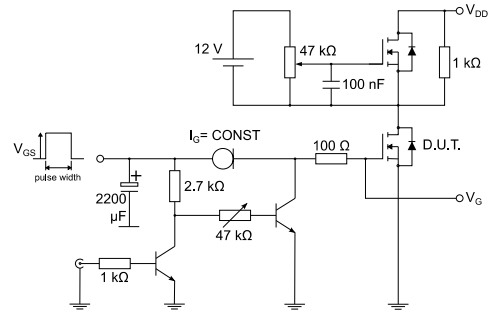

AM01469v1

Figure 16: Test circuit for inductive load switching and diode recovery times

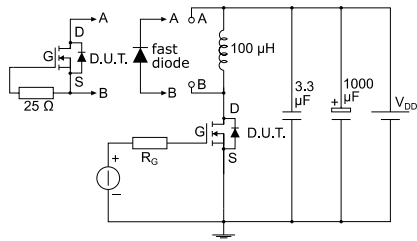

AM01470v1

Figure 17: Unclamped inductive load test circuit

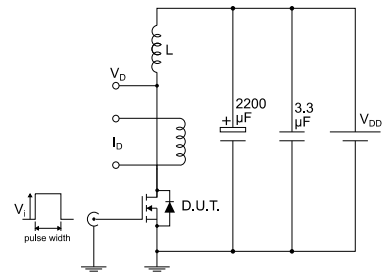

AM01471v1

Figure 18: Unclamped inductive waveform

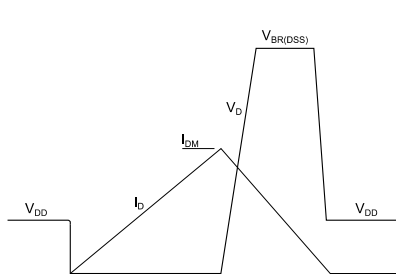

AM01472v1

Figure 19: Switching time waveform

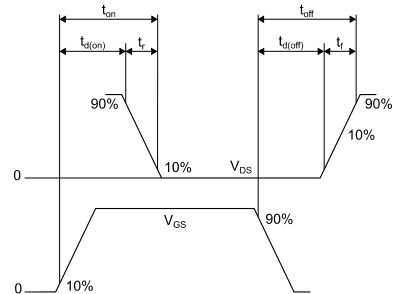

AM01473v1

4 Package information

In order to meet environmental requirements, ST offers these devices in different grades of ECOPACK® packages, depending on their level of environmental compliance. ECOPACK® specifications, grade definitions and product status are available at: www.st.com. ECOPACK® is an ST trademark.

4.1 TO-247 package information

Figure 20: TO-247 package outline

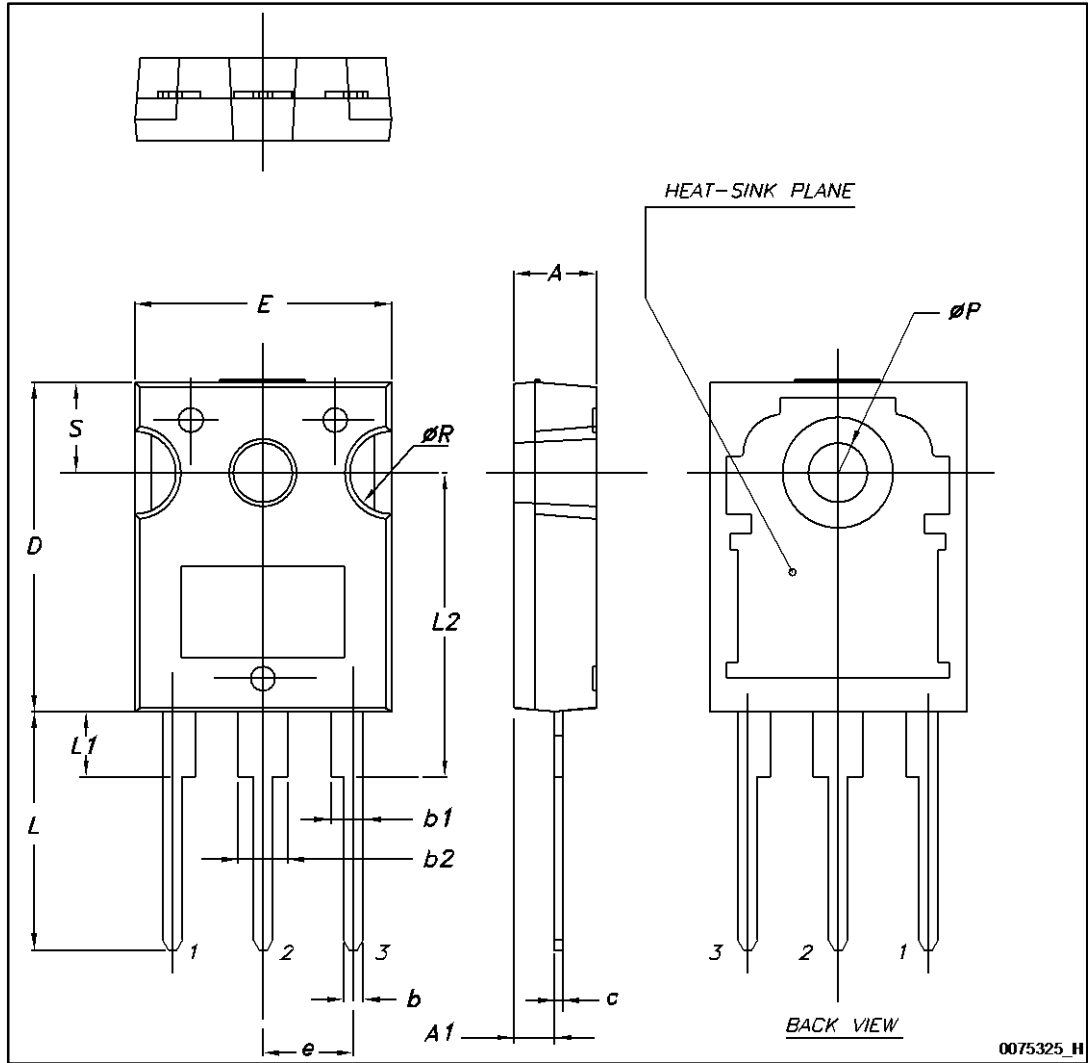

Table 9: TO-247 package mechanical data

Dim.	mm.		
	Min.	Typ.	Max.
A	4.85		5.15
A1	2.20		2.60
b	1.0		1.40
b1	2.0		2.40
b2	3.0		3.40
c	0.40		0.80
D	19.85		20.15
E	15.45		15.75
e	5.30	5.45	5.60
L	14.20		14.80
L1	3.70		4.30
L2		18.50	
ØP	3.55		3.65
ØR	4.50		5.50
S	5.30	5.50	5.70

5 Revision history

Table 10: Document revision history

Date	Revision	Changes
04-Sep-2014	1	First release.
18-May-2015	2	Document status promoted from preliminary to production data. Added Section 2.1 Electrical characteristics (curves).
08-Jul-2015	3	Text and formatting changes throughout document in Section Electrical characteristics: - updated Tables Dynamic and Source-drain diode
09-Dec-2015	4	Updated Table 4: "Avalanche characteristics" .

IMPORTANT NOTICE – PLEASE READ CAREFULLY

STMicroelectronics NV and its subsidiaries ("ST") reserve the right to make changes, corrections, enhancements, modifications, and improvements to ST products and/or to this document at any time without notice. Purchasers should obtain the latest relevant information on ST products before placing orders. ST products are sold pursuant to ST's terms and conditions of sale in place at the time of order acknowledgement.

Purchasers are solely responsible for the choice, selection, and use of ST products and ST assumes no liability for application assistance or the design of Purchasers' products.

No license, express or implied, to any intellectual property right is granted by ST herein.

Resale of ST products with provisions different from the information set forth herein shall void any warranty granted by ST for such product.

ST and the ST logo are trademarks of ST. All other product or service names are the property of their respective owners.

Information in this document supersedes and replaces information previously supplied in any prior versions of this document.

© 2015 STMicroelectronics – All rights reserved