



UNISONIC TECHNOLOGIES CO., LTD

UC2844/45

LINEAR INTEGRATED CIRCUIT

HIGH PERFORMANCE CURRENT MODE PWM CONTROLLERS

DESCRIPTION

The UTC **UC2844/2845** are high performance fixed frequency current mode controllers that specifically designed for Off-Line and DC to DC converter applications with minimal external parts count.

The differences between **UC2844** and **UC2845** are the maximum duty cycle ranges and under-voltage lockout thresholds. The **UC2844** ideally suited to off-line applications with UVLO thresholds of $16V_{(ON)}$ and $10V_{(OFF)}$, and **UC2845** has UVLO thresholds of $8.5V_{(ON)}$ and $7.6V_{(OFF)}$ for lower voltage applications.

FEATURES

- * Operation output switching frequency up to 500 kHz
- * Output deadtime adjustable from 50% to 70%
- * Automatic feed forward compensation
- * Latching PWM for cycle-by-cycle current limiting
- * High current totem pole output
- * Internally trimmed reference with under voltage lockout
- * UVLO with hysteresis
- * Low startup and operating current

ORDERING INFORMATION

Order Number		Package	Packing
Lead Free	Halogen Free		
UC2844L-S08-R	UC2844G-S08-R	SOP-8	Tape Reel
UC2845L-S08-R	UC2845G-S08-R	SOP-8	Tape Reel

<p>UC2844L-S08-R</p> <p>(1)Packing Type (2)Package Type (3)Lead Free</p>	<p>(1) R: Tape Reel (2) S08: SOP-8 (3) G: Halogen Free,L: Lead Free</p>
--	---

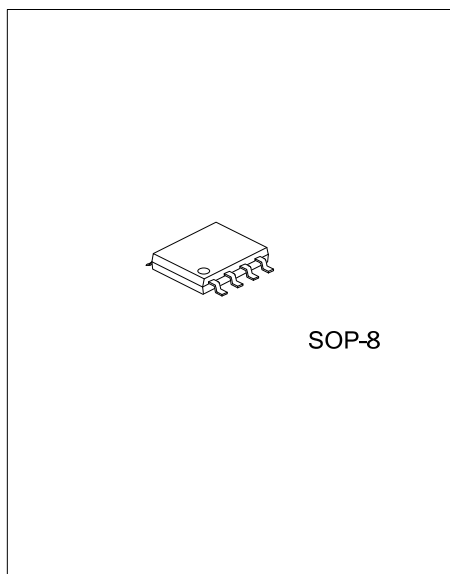

SOP-8

*Pb-free plating product number:
UC2844L/UC2845L

■ PIN CONFIGURATION

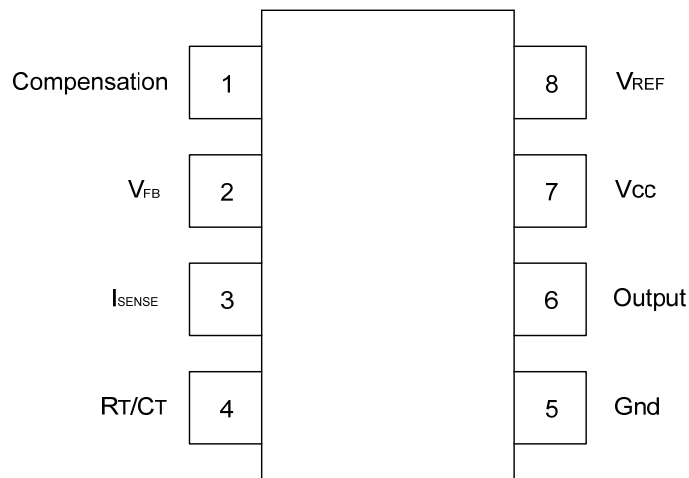

■ PIN DESCRIPTION

PIN NO	PIN NAME	FUNCTION
1	Compensation	Error amplifier output, this pin is made available for loop compensation.
2	V _{FB}	Voltage Feedback, the inverting input of the Error Amplifier. It is normally connected to the switching power supply output through a resistor divider.
3	I _{SENSE}	A voltage proportional to inductor current is connected to this input. The PWM uses this information to terminate the output switch conduction.
4	R _T /C _T	The Oscillator frequency and maximum output duty cycle are programmed by connecting resistor R _T to V _{ref} and capacitor C _T to ground. Operation to 1 MHz is possible.
5	GND	Power ground.
6	Output	This output directly drives the gate of a power MOSFET. Peak currents up to 1A are sourced and sunk by this pin. The output switches at one-half the oscillator frequency.
7	V _{CC}	Positive supply.
8	V _{REF}	Reference output, provides charging current for capacitor C _T though resistor R _T .

■ BLOCK DIAGRAM

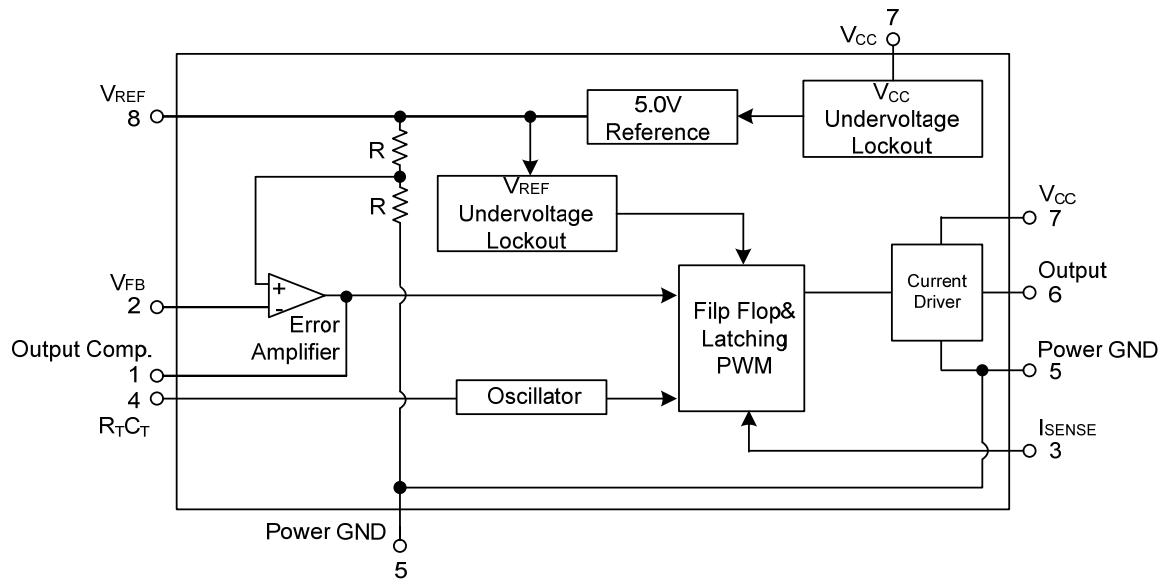

■ ABSOLUTE MAXIMUM RATINGS (Ta=25°C)

PARAMETER	SYMBOL	RATINGS	UNIT
Total Power Supply and Zener Current	(I _{CC} +I _Z)	30	mA
Output Current, Source or Sink (Note 2)	I _{OUT}	1.0	A
Output Energy (Capacitive Load per cycle)	W	5.0	μJ
Current Sense and Voltage feedback Inputs	V _{IN}	-0.3 ~ +5.5	V
Error Amp Output Sink Current	I _{SINK}	10	mA
Power Dissipation	P _D	862	mW
Junction Temperature	T _J	+150	°C
Operating Junction Temperature	T _{J(OPR)}	-40 ~ +120	°C
Storage Temperature Range	T _{STG}	-65 ~ +150	°C

Note:1.Absolute maximum ratings are those values beyond which the device could be permanently damaged.

Absolute maximum ratings are stress ratings only and functional device operation is not implied.

2.Maxmum package power dissipation limits must be observed.

■ THERMAL DATA

PARAMETER	SYMBOL	RATINGS	UNIT
Thermal Resistance(Junction-to-Air)	θ _{JA}	145	°C/W

■ ELECTRICAL CHARACTERISTICS

(Ta=25°C, V_{CC}=15V, R_T=10k, C_T=3.3nF, -40°C ≤ T_A ≤ 120°C, unless otherwise specified)

PARAMETER	SYMBOL	TEST CONDITIONS	MIN	TYP	MAX	UNIT
REFERENCE SECTION						
Reference Output Voltage	V _{REF}	I _{OUT} =1.0mA, T _J =25 C	4.95	5.0	5.05	V
Line Regulation	ΔV _{OUT}	V _{CC} =12V ~ 25V		2.0	20	mV
Load Regulation	ΔV _{OUT}	I _{OUT} =1.0mA ~ 20mA		3.0	25	mV
Temperature Stability	t _S			0.2		mV/°C
Total Output Variation over Line, Load, Temperature	V _{REF}		4.9		5.1	V
Output Noise Voltage	eN	f=10Hz ~ 10kHz, T _J =25°C		50		μV
Long Term Stability	S	T _A =125°C for 1000 Hours		5		mV
Output Short Circuit Current	I _{SC}		-30	-85	-180	mA
OSCILLATOR SECTION						
Oscillator Voltage Swing	V _{OSC}			1.6		V
Discharge Current	IDSG	V _{OSC} =2.0V, T _J =25°C		10.8		mA
Frequency	f _{OSC}	T _J =25°C,	47	52	57	kHz
		T _{LOW} ≤ T _A ≤ T _H	46		60	
Frequency Change with Voltage	Δf _{OSC} /ΔV	V _{CC} =12V ~ 25V		0.2	1.0	%
Frequency Change with Temperature	Δf _{OSC} /ΔT	T _{LOW} ≤ T _A ≤ T _H		5.0		%
ERROR AMPLIFIER SECTION						
Voltage Feedback Input	V _{FB}	V _{OUT} =2.5V	2.45	2.50	2.55	V
Output Voltage Swing	High	V _{OH}	R _L =15k to ground, V _{FB} =2.3V	5.0	6.2	V
	Low	V _{OL}	R _L =15k to V _{REF} , V _{FB} =2.7V		0.8	
Output Current	Sink	I _{SINK}	V _{OUT} =1.1V, V _{FB} =2.7V	2.0	12	mA
	Source	I _{SOURCE}	V _{OUT} =5.0V, V _{FB} =2.3V	-0.5	-1.0	
Input Bias Current	I _{I(BIAS)}	V _{FB} =2.7V		-0.1	-1.0	μA
Open Loop Voltage Gain	G _{VO}	V _{OUT} =2.0V ~ 4.0V	65	90		dB
Power Supply Rejection Ratio	PSRR	V _{CC} =12V ~ 25V	60	70		dB
Unity Gain Bandwidth	GB _W	T _J =25°C	0.7	1.0		MHz

■ ELECTRICAL CHARACTERISTICS(Cont.)

PARAMETER	SYMBOL	TEST CONDITIONS	MIN	TYP	MAX	UNIT	
CURRENT SENSE SECTION							
Current Sense Input Voltage Gain (Note 2 & 3)	G_V		2.85	3.0	3.15	V/V	
Maximum Current Sense Input Threshold (Note 2)	$V_{I(THR)}$		0.9	1.0	1.1	V	
Input Bias Current	$I_{I(BIAS)}$			-2.0	-10	μA	
Power Supply Rejection Ratio	PSRR	$V_{CC}=12V \sim 25V$ (Note4)		70		dB	
Propagation Delay	$t_{PLH(IN/OUT)}$			150	300	ns	
OUTPUT SECTION							
Output Voltage	Low	V_{OL}	$I_{SINK}=20mA$		0.1	0.4	V
			$I_{SINK}=200mA$		1.6	2.2	
	High	V_{OH}	$I_{SINK}=20mA$	13	13.5		V
			$I_{SINK}=200mA$	12	13.4		
Output Voltage with U_{VLO} Activated	$V_{OL}(U_{VLO})$	$V_{CC}=6.0V, I_{SINK}=1.0mA$		0.1	1.1	V	
Output Voltage Rise Time	t_R	$C_L=1.0nF, T_J=25^\circ C$		50	150	ns	
Output Voltage Fall Time	t_F	$C_L=1.0nF, T_J=25^\circ C$		50	150	ns	
UNDERVOLTAGE LOCKOUT SECTION							
Startup Threshold	UC2844	V_{THR}		15	16.0	17	V
	UC2845			7.8	8.4	9.0	
Minimum Operating Voltage After Turn-On	UC2844	$V_{CC(MIN)}$		9.0	10.0	11.0	V
	UC2845			7.0	7.6	8.2	
PWM SECTION							
Duty Cycle	Max	DC_{MAX}		47	48	50	%
	Min	DC_{MIN}				0	%
TOTAL DEVICE							
Power Supply Zener Voltage	V_Z	$I_{CC}=25mA$	30	36	-	V	
Power Supply Current (Note 4)	UC2845	I_{CC}	$V_{CC}=6.5V$		0.5	1.0	mA
	UC2844		$V_{CC}=14V$		12	17	

Note: 1. Low duty cycle pulse techniques are used during test to maintain junction temperature as close to ambient as possible.

2. This parameter is measured at the latch trip point with $V_{FB}=0V$.

3. Comparator gain is defined as: $A_V = \frac{\Delta V \text{ Output Compensation}}{\Delta V \text{ Current Sense Input}}$

4. Adjust V_{CC} above the startup threshold before setting to 15V.

TYPICAL CHARACTERISTICS

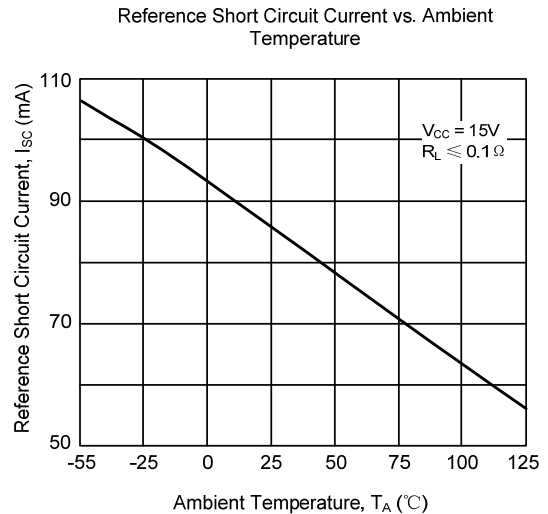
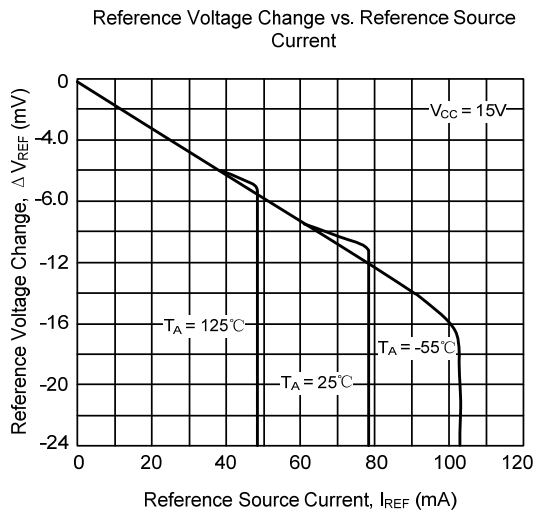
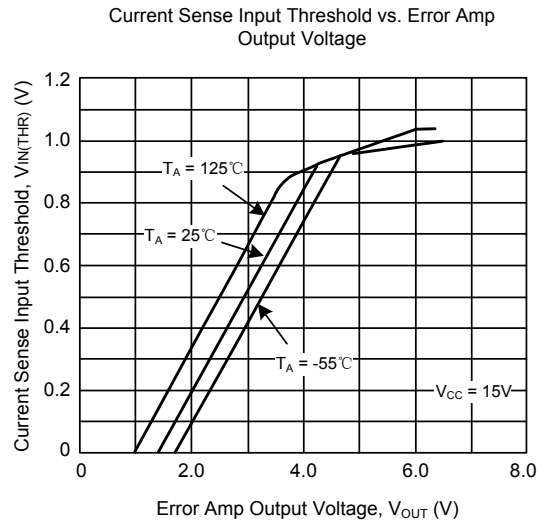
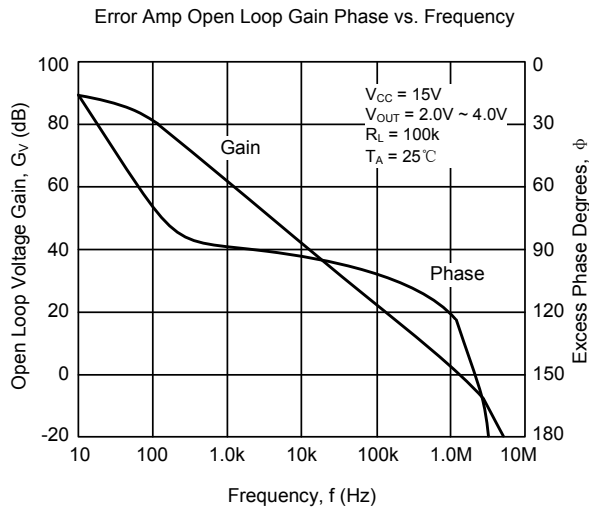
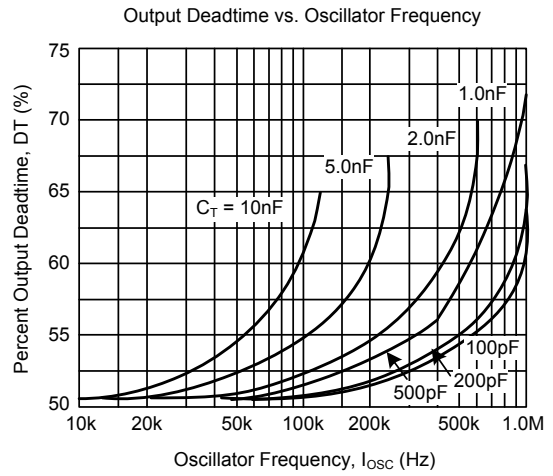
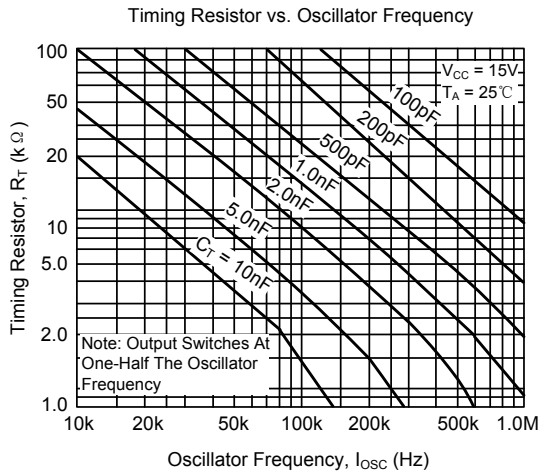

■ TYPICAL CHARACTERISTICS(Cont.)

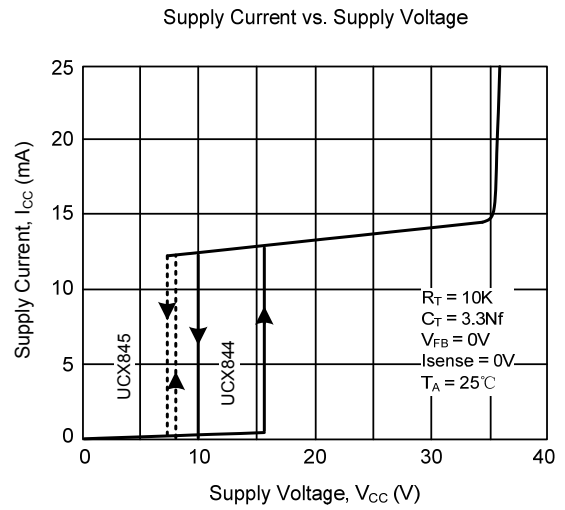
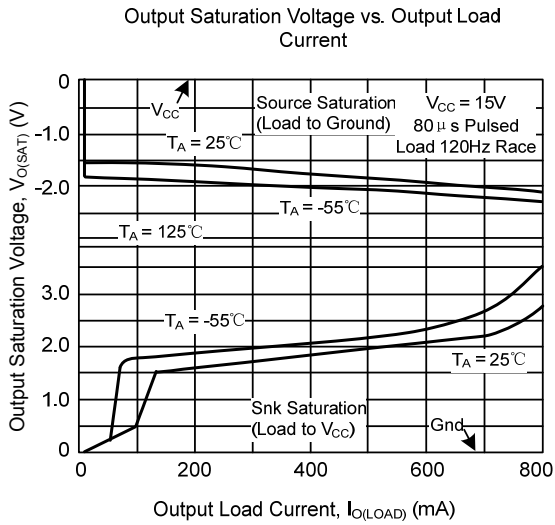

UTC assumes no responsibility for equipment failures that result from using products at values that exceed, even momentarily, rated values (such as maximum ratings, operating condition ranges, or other parameters) listed in products specifications of any and all UTC products described or contained herein. UTC products are not designed for use in life support appliances, devices or systems where malfunction of these products can be reasonably expected to result in personal injury. Reproduction in whole or in part is prohibited without the prior written consent of the copyright owner. The information presented in this document does not form part of any quotation or contract, is believed to be accurate and reliable and may be changed without notice.