

HC1

High Power Resonant Capacitors



FEATURES

High AC Voltage - High current

APPLICATIONS

Induction Heating - Tank Circuits

KVAR	150
CAPACITANCE TOLERANCE	+/-10%
MAXIMUM CORE TEMPERATURE	+85°C
SURFACE TEMPERATURE	+45°C (Above 45°C the KVAR rating must be de-rated by 2.25%/°C)
CONSTRUCTION	Self-healing
SELF INDUCTANCE	<3 nH
DIELECTRIC	Polypropylene
FLAME RETARDANT	UL94V0

Standard part listing

Capacitance (µF)	VAC	IC part number	Maximum RMS current (A)	MAX power KVAR	Frequency range (kHz)	ESR (mΩ) 100kHz, +25°C	Dimensions (mm)			Terminal Style
							B	H	L	
0.05	1000	503HC1102K2CM6	200	150	478-700	1.5	30.2	30	68	2CM6
0.1	1000	104HC1102K2CM6	250	150	238-423	1.5	30.2	30	68	2CM6
0.17	700	174HC1700K2CM6	250	150	286-389	1.2	30.2	30	68	2CM6
0.25	700	254HC1700K2CM6	250	150	195-265	1.2	30.2	30	68	2CM6
0.33	700	334HC1700K2CM6	250	150	148-200	1	30.2	30	68	2CM6
0.5	700	504HC1700K2CM6	250	150	93-132	1	30.2	30	68	2CM6
0.66	600	664HC1600K2CM6	300	150	100-145	0.8	30.2	30	68	2CM6
1.2	500	125HC1500K2CM6	300	150	79-80	0.6	30.2	30	68	2CM6
1.33	500	135HC1500K2CM6	300	150	72	0.6	30.2	30	68	2CM6
2.4	400	245HC1400K2CM6	400	150	63-72	0.6	30.2	30	68	2CM6



Your Global Source for World-Class Capacitors

© 2013 Illinois Capacitor, Inc.

North America
Tel: 847.675.1760
sales@illcap.com

Asia
Tel: 852.2793 0931
sales@illcap.com.hk



LEAD STYLE: 2CM6

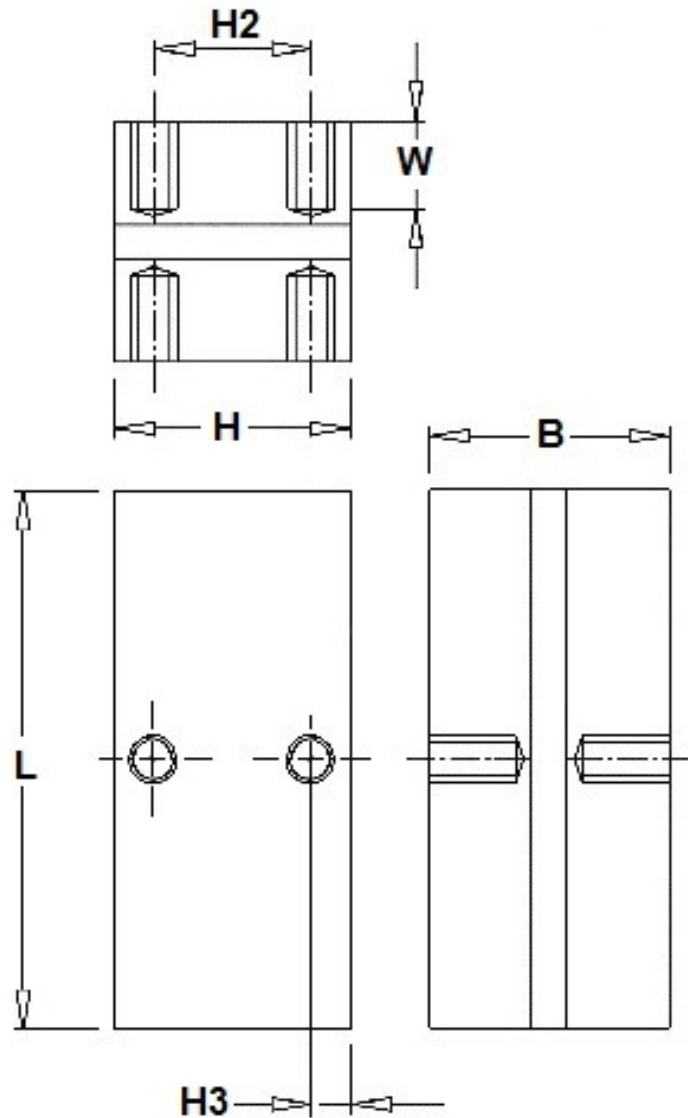

L	H	B	H2	H3	W
68±0.5	30±0.5	30.2±0.1	20	5	10
Mounting Holes: M6x1 Tap fitted with SS helicoil					
Tightening torque: 15Nm MAX					

HC1

High Power Resonant Capacitors



Frequency Derating

—●— Voltage —■— Current —▲— Power

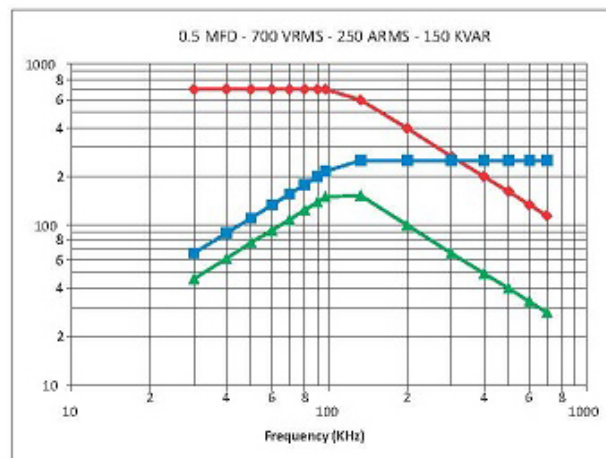
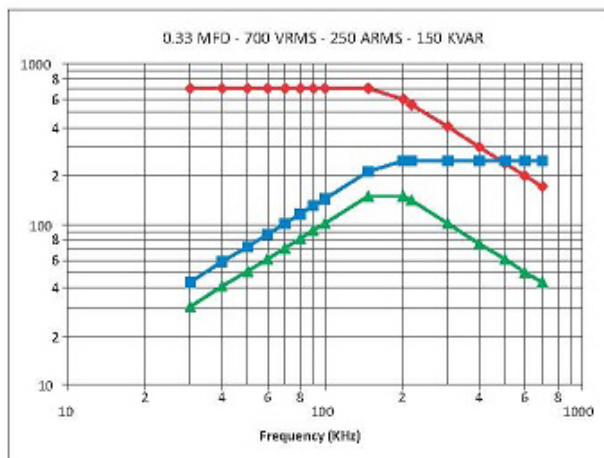
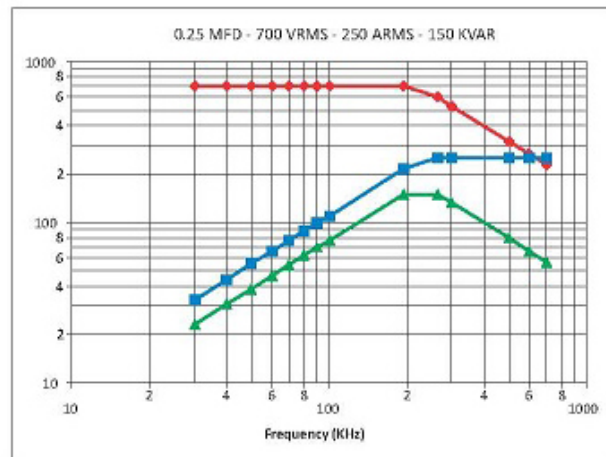
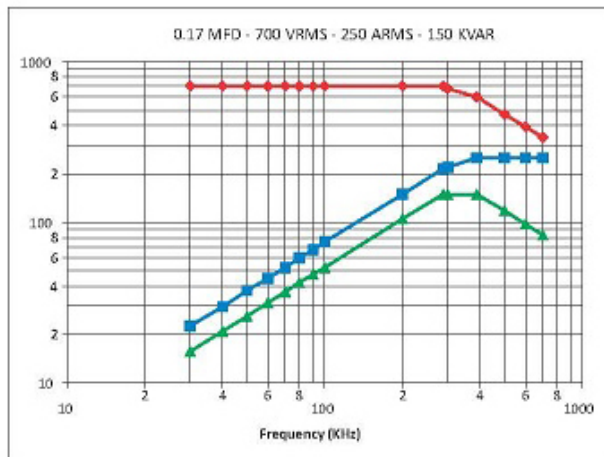
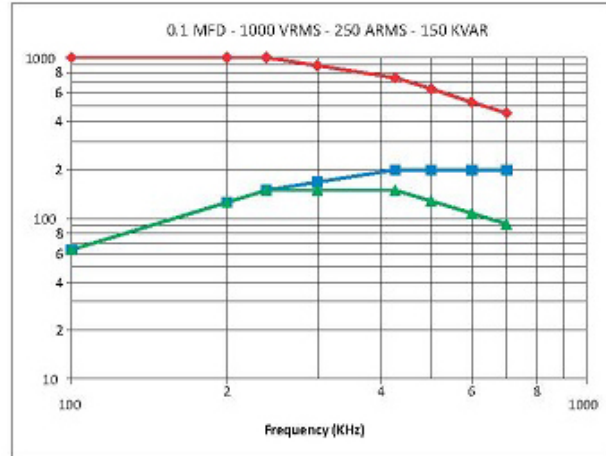
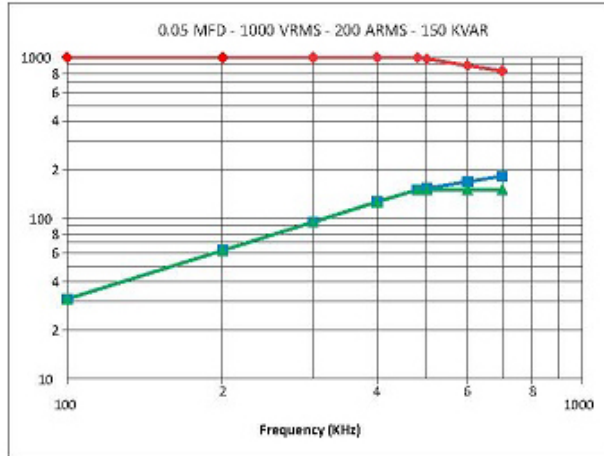

ILLINOIS CAPACITOR

Your Global Source for World-Class Capacitors

© 2013 Illinois Capacitor, Inc.

North America
Tel: 847.675.1760
sales@illcap.com

Asia
Tel: 852.2793 0931
sales@illcap.com.hk



Frequency Derating

—●— Voltage —■— Current —▲— Power

