

Plastic Darlington Complementary Silicon Power Transistors

... designed for general-purpose amplifier and low-speed switching applications.

- High DC Current Gain —
 $h_{FE} = 2000$ (Typ) @ $I_C = 2.0$ Adc
- Collector–Emitter Sustaining Voltage — @ 100 mA dc
 $V_{CEO(sus)} = 60$ Vdc (Min) — 2N6035, 2N6038 = 80 Vdc (Min) — 2N6036, 2N6039
- Forward Biased Second Breakdown Current Capability
 $I_{S/b} = 1.5$ Adc @ 25 Vdc
- Monolithic Construction with Built–In Base–Emitter Resistors to Limit Leakage Multiplication
- Space–Saving High Performance–to–Cost Ratio TO–225AA Plastic Package

MAXIMUM RATINGS (1)

Rating	Symbol	2N6035 2N6038	2N6036 2N6039	Unit
Collector–Emitter Voltage	V_{CEO}	60	80	Vdc
Collector–Base Voltage	V_{CB}	60	80	Vdc
Emitter–Base Voltage	V_{EB}	5.0		Vdc
Collector Current — Continuous Peak	I_C	4.0 8.0		Adc
Base Current	I_B	100		mAdc
Total Power Dissipation @ $T_C = 25^\circ\text{C}$ Derate above 25°C	P_D	40 0.32		Watts W/ $^\circ\text{C}$
Total Power Dissipation @ $T_A = 25^\circ\text{C}$ Derate above 25°C	P_D	1.5 0.012		Watts
Operating and Storage Junction Temperature Range	T_J, T_{stg}	–65 to +150		$^\circ\text{C}$

THERMAL CHARACTERISTICS

Characteristic	Symbol	Max	Unit
Thermal Resistance, Junction to Case	θ_{JC}	3.12	$^\circ\text{C/W}$
Thermal Resistance, Junction to Ambient	θ_{JA}	83.3	$^\circ\text{C/W}$

(1) Indicates JEDEC Registered Data.

**PNP
2N6035**
2N6036*
**NPN
2N6038**
2N6039*

*ON Semiconductor Preferred Device

**DARLINGTON
4–AMPERE
COMPLEMENTARY
SILICON
POWER TRANSISTORS
60, 80 VOLTS
40 WATTS**

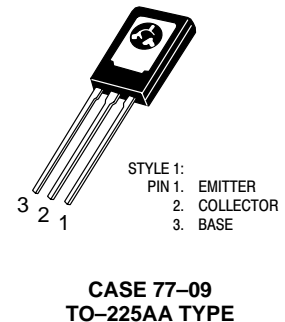

Preferred devices are ON Semiconductor recommended choices for future use and best overall value.

2N6035 2N6036 2N6038 2N6039

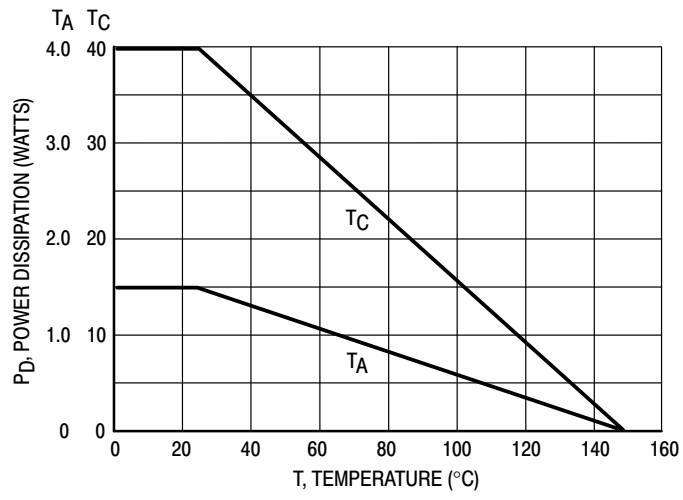

Figure 1. Power Derating

2N6035 2N6036 2N6038 2N6039

ELECTRICAL CHARACTERISTICS (T_C = 25°C unless otherwise noted)

Characteristic	Symbol	Min	Max	Unit
OFF CHARACTERISTICS				
Collector-Emitter Sustaining Voltage (I _C = 100 mAdc, I _B = 0)	V _{CEO(sus)}	60 80	— —	Vdc
Collector-Cutoff Current (V _{CE} = 60 Vdc, I _B = 0) (V _{CE} = 80 Vdc, I _B = 0)	I _{CEO}	— —	100 100	μA
Collector-Cutoff Current (V _{CE} = 60 Vdc, V _{BE(off)} = 1.5 Vdc) (V _{CE} = 80 Vdc, V _{BE(off)} = 1.5 Vdc) (V _{CE} = 60 Vdc, V _{BE(off)} = 1.5 Vdc, T _C = 125°C) (V _{CE} = 80 Vdc, V _{BE(off)} = 1.5 Vdc, T _C = 125°C)	I _{CEX}	— — — —	100 100 500 500	μA
Collector-Cutoff Current (V _{CB} = 60 Vdc, I _E = 0) (V _{CB} = 80 Vdc, I _E = 0)	I _{CBO}	— —	0.5 0.5	mAdc
Emitter-Cutoff Current (V _{BE} = 5.0 Vdc, I _C = 0)	I _{EBO}	—	2.0	mAdc

ON CHARACTERISTICS

DC Current Gain (I _C = 0.5 Adc, V _{CE} = 3.0 Vdc) (I _C = 2.0 Adc, V _{CE} = 3.0 Vdc) (I _C = 4.0 Adc, V _{CE} = 3.0 Vdc)	h _{FE}	500 750 100	— 15,000 —	—
Collector-Emitter Saturation Voltage (I _C = 2.0 Adc, I _B = 8.0 mAdc) (I _C = 4.0 Adc, I _B = 40 mAdc)	V _{CE(sat)}	— —	2.0 3.0	Vdc
Base-Emitter Saturation Voltage (I _C = 4.0 Adc, I _B = 40 mAdc)	V _{BE(sat)}	—	4.0	Vdc
Base-Emitter On Voltage (I _C = 2.0 Adc, V _{CE} = 3.0 Vdc)	V _{BE(on)}	—	2.8	Vdc

DYNAMIC CHARACTERISTICS

Small-Signal Current-Gain (I _C = 0.75 Adc, V _{CE} = 10 Vdc, f = 1.0 MHz)	h _{fe}	25	—	—
Output Capacitance (V _{CB} = 10 Vdc, I _E = 0, f = 0.1 MHz)	C _{ob}	— —	200 100	pF

*Indicates JEDEC Registered Data.

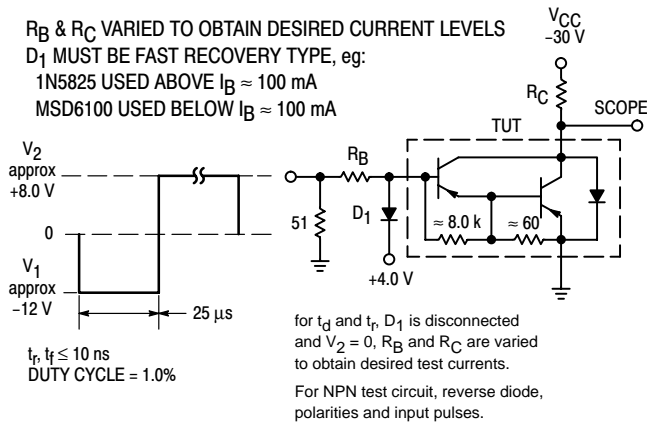

Figure 2. Switching Times Test Circuit

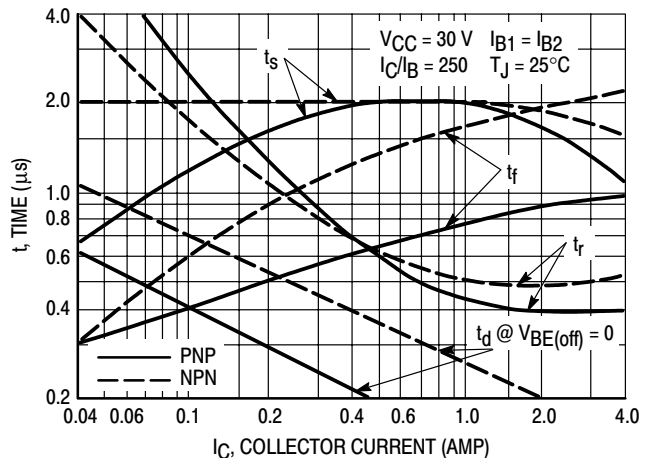

Figure 3. Switching Times

2N6035 2N6036 2N6038 2N6039

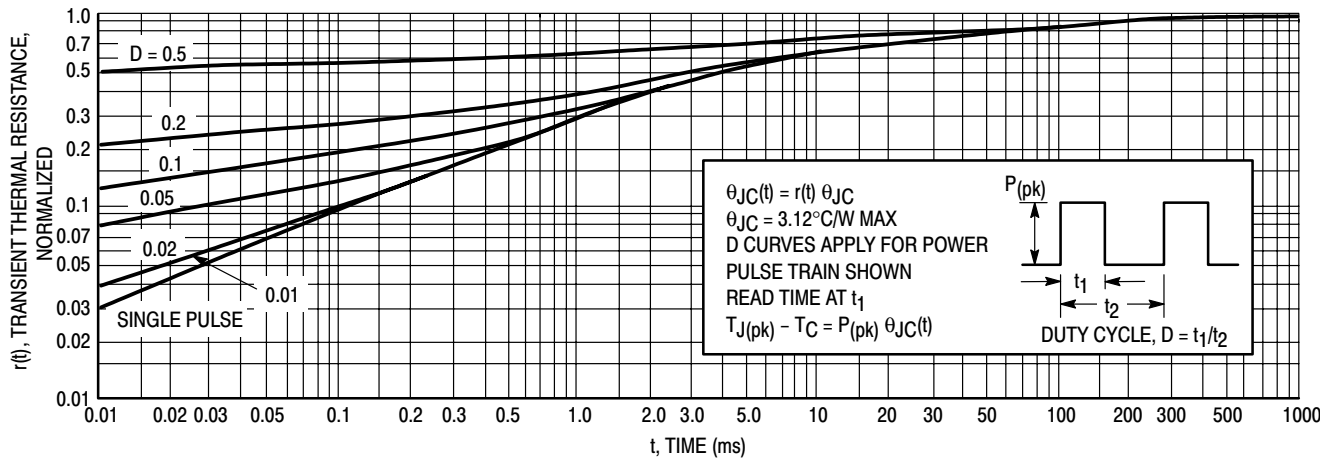

Figure 4. Thermal Response

ACTIVE-REGION SAFE-OPERATING AREA

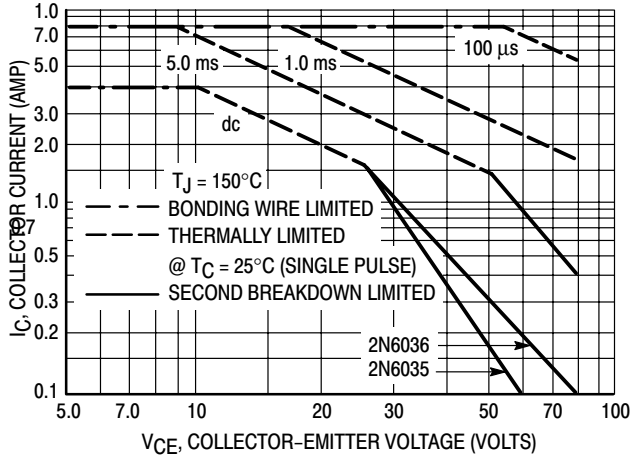

Figure 5. 2N6035, 2N6036

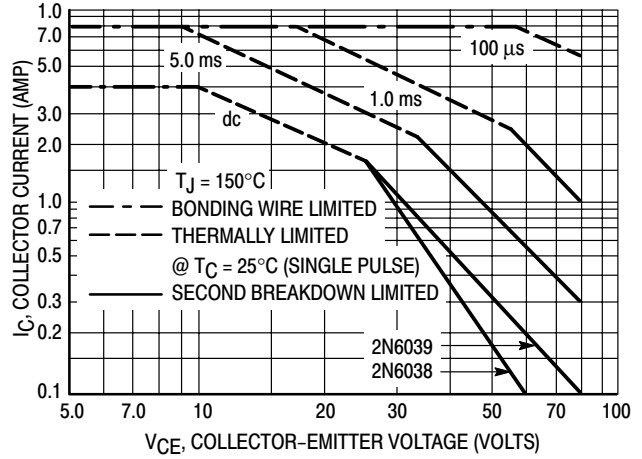

Figure 6. 2N6038, 2N6039

There are two limitations on the power handling ability of a transistor: average junction temperature and second breakdown. Safe operating area curves indicate $I_C - V_{CE}$ limits of the transistor that must be observed for reliable operation; i.e., the transistor must not be subjected to greater dissipation than the curves indicate.

The data of Figures 5 and 6 is based on $T_{J(pk)} = 150^\circ\text{C}$; T_C is variable depending on conditions. Second breakdown pulse limits are valid for duty cycles to 10% provided $T_{J(pk)} < 150^\circ\text{C}$. $T_{J(pk)}$ may be calculated from the data in Figure 4. At high case temperatures, thermal limitations will reduce the power that can be handled to values less than the limitations imposed by second breakdown.

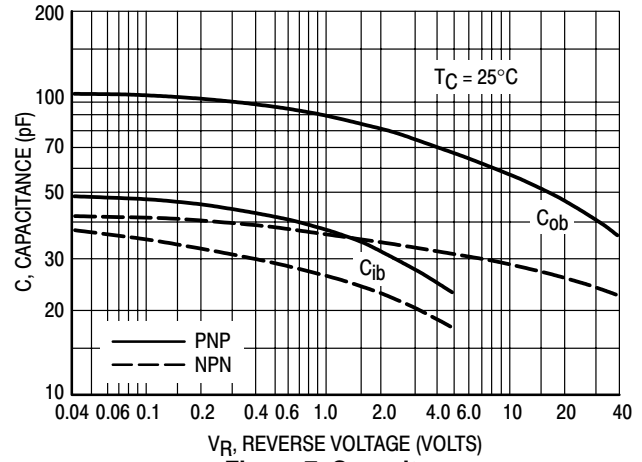

Figure 7. Capacitance

2N6035 2N6036 2N6038 2N6039

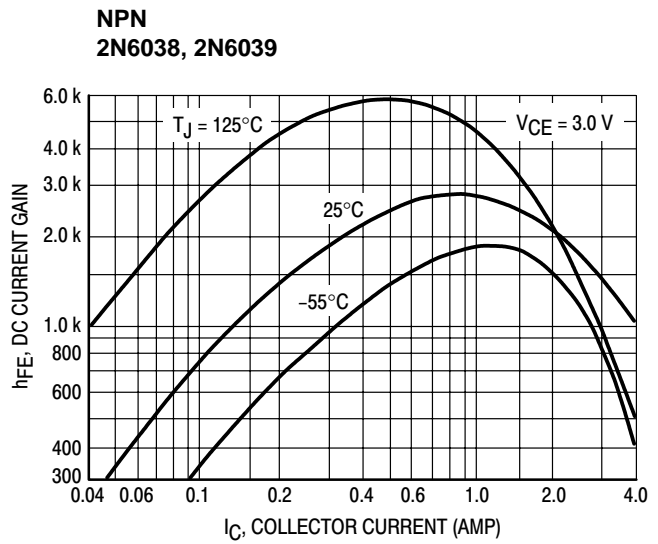
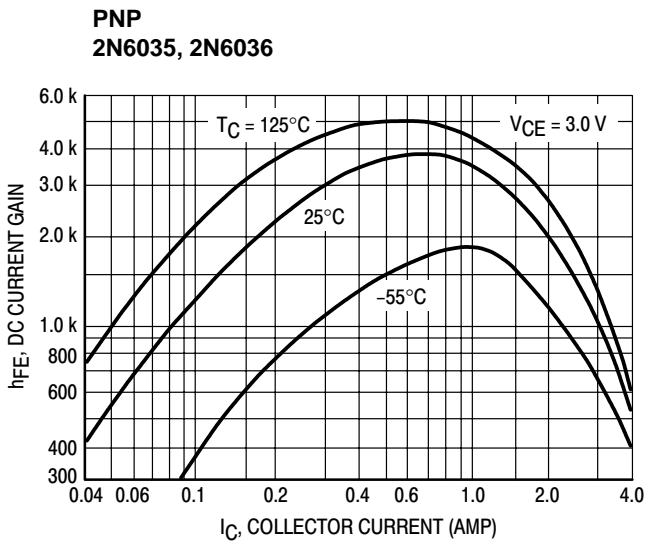

Figure 8. DC Current Gain

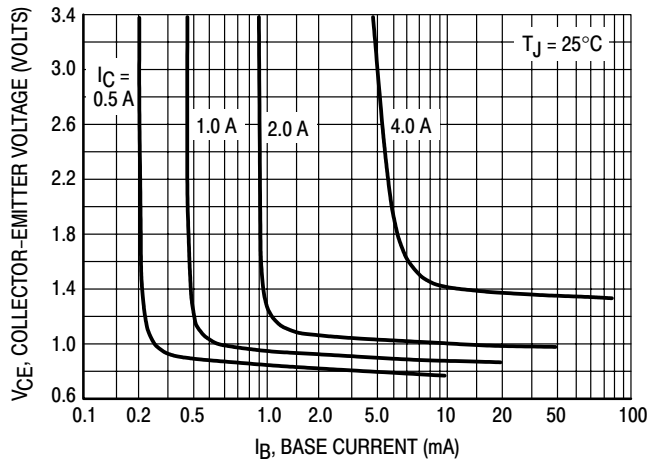
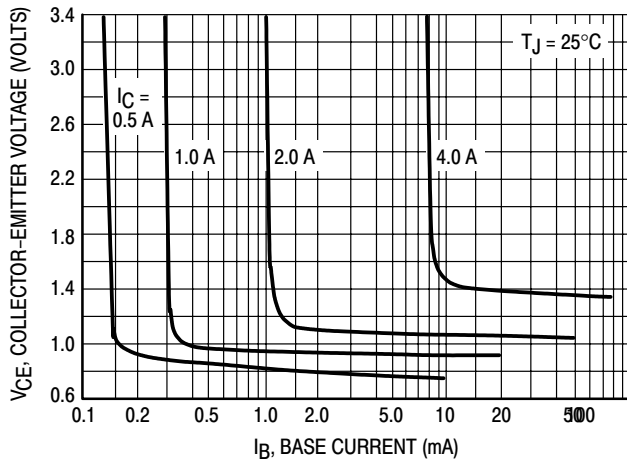

Figure 9. Collector Saturation Region

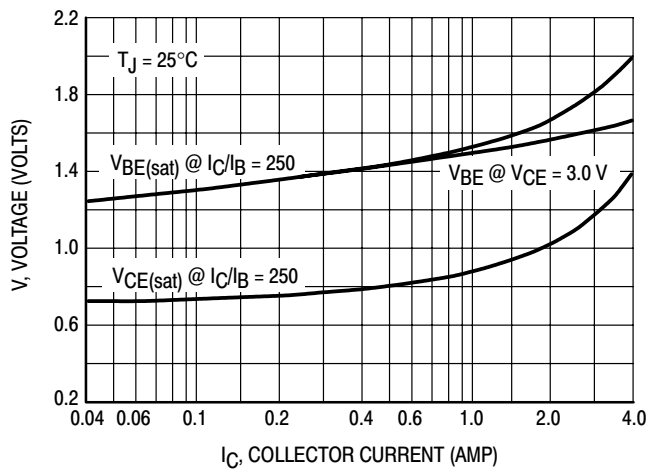
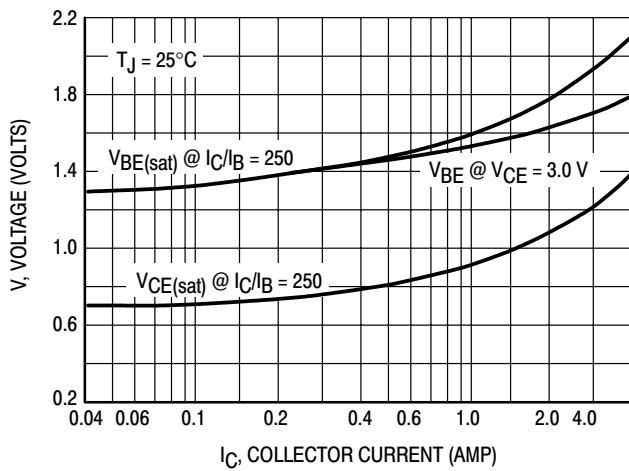
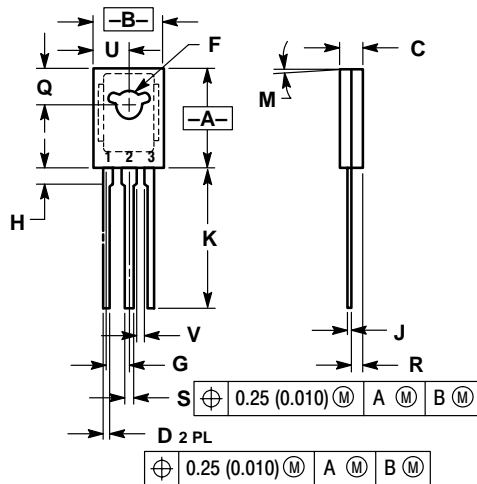

Figure 10. "On" Voltages

2N6035 2N6036 2N6038 2N6039

PACKAGE DIMENSIONS

TO-225AA
CASE 77-09
ISSUE W



- NOTES:
1. DIMENSIONING AND TOLERANCING PER ANSI Y14.5M, 1982.
2. CONTROLLING DIMENSION: INCH.

DIM	INCHES		MILLIMETERS	
	MIN	MAX	MIN	MAX
A	0.425	0.435	10.80	11.04
B	0.295	0.305	7.50	7.74
C	0.095	0.105	2.42	2.66
D	0.020	0.026	0.51	0.66
F	0.115	0.130	2.93	3.30
G	0.094 BSC		2.39 BSC	
H	0.050	0.095	1.27	2.41
J	0.015	0.025	0.39	0.63
K	0.575	0.655	14.61	16.63
M	5° TYP		5° TYP	
Q	0.148	0.158	3.76	4.01
R	0.045	0.065	1.15	1.65
S	0.025	0.035	0.64	0.88
U	0.145	0.155	3.69	3.93
V	0.040	---	1.02	---

- STYLE 1:
PIN 1. EMITTER
2. COLLECTOR
3. BASE

ON Semiconductor and  are registered trademarks of Semiconductor Components Industries, LLC (SCILLC). SCILLC reserves the right to make changes without further notice to any products herein. SCILLC makes no warranty, representation or guarantee regarding the suitability of its products for any particular purpose, nor does SCILLC assume any liability arising out of the application or use of any product or circuit, and specifically disclaims any and all liability, including without limitation special, consequential or incidental damages. "Typical" parameters which may be provided in SCILLC data sheets and/or specifications can and do vary in different applications and actual performance may vary over time. All operating parameters, including "Typicals" must be validated for each customer application by customer's technical experts. SCILLC does not convey any license under its patent rights nor the rights of others. SCILLC products are not designed, intended, or authorized for use as components in systems intended for surgical implant into the body, or other applications intended to support or sustain life, or for any other application in which the failure of the SCILLC product could create a situation where personal injury or death may occur. Should Buyer purchase or use SCILLC products for any such unintended or unauthorized application, Buyer shall indemnify and hold SCILLC and its officers, employees, subsidiaries, affiliates, and distributors harmless against all claims, costs, damages, and expenses, and reasonable attorney fees arising out of, directly or indirectly, any claim of personal injury or death associated with such unintended or unauthorized use, even if such claim alleges that SCILLC was negligent regarding the design or manufacture of the part. SCILLC is an Equal Opportunity/Affirmative Action Employer.

PUBLICATION ORDERING INFORMATION

Literature Fulfillment:

Literature Distribution Center for ON Semiconductor
P.O. Box 5163, Denver, Colorado 80217 USA
Phone: 303-675-2175 or 800-344-3860 Toll Free USA/Canada
Fax: 303-675-2176 or 800-344-3867 Toll Free USA/Canada
Email: ONlit@hibbertco.com

N. American Technical Support: 800-282-9855 Toll Free USA/Canada

JAPAN: ON Semiconductor, Japan Customer Focus Center
4-32-1 Nishi-Gotanda, Shinagawa-ku, Tokyo, Japan 141-0031
Phone: 81-3-5740-2700
Email: r14525@onsemi.com

ON Semiconductor Website: <http://onsemi.com>

For additional information, please contact your local Sales Representative.