

PLEASE CHECK WWW.MOLEX.COM FOR LATEST PART INFORMATION

Part Number: [0874271442](#)
Status: **Active**
Overview: [minifit_jr](#)
Description: 4.20mm (.165") Mini-Fit Jr.™ Header, Vertical, Nylon, without Flange, 14Circuits, Tin (Sn) over Nickel (Ni) Plating, Glow Wire Compatible

Documents:

[3D Model](#) [Product Specification PS-87427-0001 \(PDF\)](#)
[Drawing \(PDF\)](#) [RoHS Certificate of Compliance \(PDF\)](#)

Agency Certification

CSA LR19980
 UL E29179

General

Product Family PCB Headers
 Series [87427](#)
 Application Wire-to-Board
 Comments Current = 13A max. per circuit when header is mated to a receptacle loaded with [45750](#) Mini-Fit Plus HCS™ Crimp Terminal Crimped to to 16 AWG wire. . See Molex product specification PS-45750-001 for additional current de-rating information.

Overview [minifit_jr](#)
 Product Name Mini-Fit Jr.™

Physical

Breakaway No
 Circuits (Loaded) 14
 Color - Resin Beige
 Durability (mating cycles max) 30
 First Mate / Last Break No
 Flammability 94V-0
 Glow-Wire Compliant Yes
 Lock to Mating Part Yes
 Material - Metal Brass
 Material - Plating Mating Tin
 Material - Plating Termination Tin
 Material - Resin Nylon
 Number of Rows 2
 Orientation Vertical
 PC Tail Length (in) 0.130 In
 PC Tail Length (mm) 3.30 mm
 PCB Locator No
 PCB Retention None
 PCB Thickness Recommended (in) 0.062 In
 PCB Thickness Recommended (mm) 1.60 mm
 Packaging Type Tray
 Pitch - Mating Interface (in) 0.165 In
 Pitch - Mating Interface (mm) 4.20 mm
 Pitch - Term. Interface (in) 0.165 In
 Pitch - Term. Interface (mm) 4.20 mm
 Plating min: Mating (µin) 101.6
 Plating min: Mating (µm) 2.54
 Plating min: Termination (µin) 101.6
 Plating min: Termination (µm) 2.54

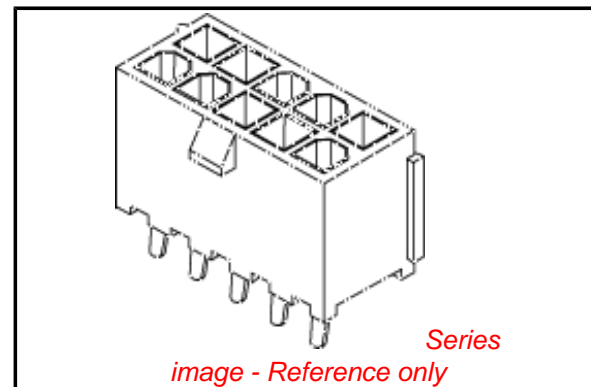

EU RoHS

ELV and RoHS Compliant
REACH SVHC Contains SVHC: No
Halogen-Free Status

China RoHS



Not Halogen-Free

Need more information on product environmental compliance?

Email productcompliance@molex.com
 For a multiple part number RoHS Certificate of Compliance, [click here](#)

Please visit the [Contact Us](#) section for any non-product compliance questions.

Search Parts in this Series

[87427Series](#)

Mates With

[5557](#) Mini-Fit Jr.™ Receptacle Housing

Polarized to Mating Part	Yes
Polarized to PCB	No
Shrouded	Fully
Stackable	No
Surface Mount Compatible (SMC)	No
Temperature Range - Operating	-40°C to +105°C
Termination Interface: Style	Through Hole

Electrical

Current - Maximum per Contact	13A
Voltage - Maximum	600V

Solder Process Data

Duration at Max. Process Temperature (seconds)	30
Lead-free Process Capability	SMC & Wave Capable (TH only)
Max. Cycles at Max. Process Temperature	2
Process Temperature max. C	240

Material Info

Reference - Drawing Numbers

Packaging Specification	PK-87427-004
Product Specification	PS-87427-0001
Sales Drawing	SD-87427-***4*

This document was generated on 05/31/2010

PLEASE CHECK WWW.MOLEX.COM FOR LATEST PART INFORMATION

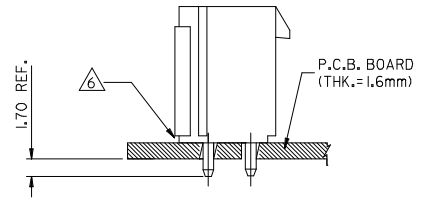
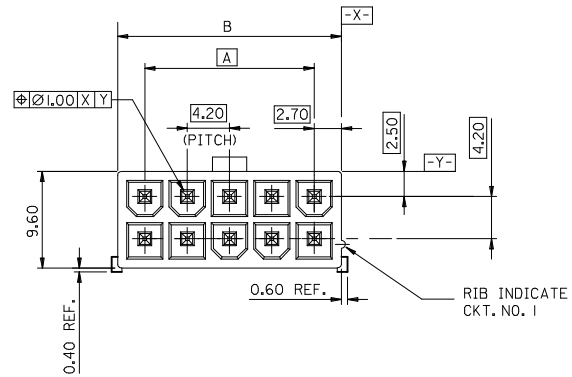

RECOMMENDED INSTALLATION PATTERN

LEGEND

87427-***4*
 CKT. SIZE — PLATING OPTIONS
 2 = NOTE 2
 3 = NOTE 3
 8 = NOTE 8

NOTES

- MATERIAL - HOUSING : NYLON 46, UL94V-0, COLOR BEIGE
 PIN : BRASS (1.07 SQUARE)
- PLATING OF PIN
 TIN 2.54um MIN. OVER NICKEL 1.27um MIN.
- PLATING OF PIN
 TIN 4-10um OVER COPPER 2-8um.
- PLATING OF PIN
 GOLD 0.76um MIN. OVER NICKEL 1.27um MIN.
- PLATING OF PIN
 TIN 2.54um MIN. OVER NICKEL 1.27um MIN. WITH MATT FINISH
- HOUSING STANDOFF (0.70 mm REF.)
- PART NUMBERS 36633-0025 TO 36633-0029 & 36633-0033 TO 36633-0039 INCLUDED AS SHOWN IN TABLE 'X'.

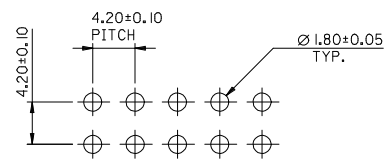
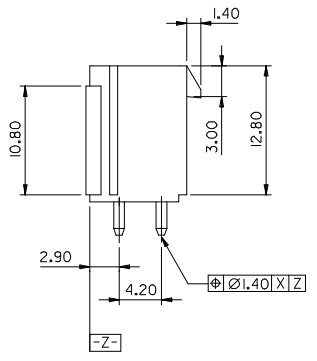
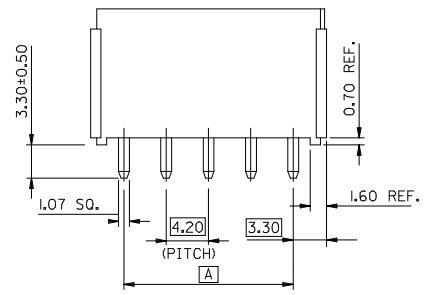

RECOMMENDED P.C.B.LAYOUT

ENTER DESCRIPTION EC NO: I2009-0573 DRWN:HR01 2009/11/11 CHKD:KPRASAD 2009/11/12 APPR:KPRASAD 2009/11/13 REV DESCRIPTION	QUALITY SYMBOLS	GENERAL TOLERANCES (UNLESS SPECIFIED)	DIMENSION STYLE	SCALE	DESIGN UNITS	THIRD ANGLE PROJECTION	
	▽=0 C=0	mm INCH	MM ONLY	2:1	METRIC		
		4 PLACES ± --- ± --- 3 PLACES ± --- ± --- 2 PLACES ± 0.20 ± --- 1 PLACE ± --- ± --- ANGULAR ± ---°	DRAWN BY DATE SAM.C 960401 CHECKED BY DATE	TITLE 4.2MM W-T-B HIGH TEMP VERT. HEADER W/O FLANGES			
		DRAFT WHERE APPLICABLE MUST REMAIN WITHIN DIMENSIONS	APPROVED BY DATE	MATERIAL NO. SEE SHEET 2	DOCUMENT NO. SD-87427-***4*	SHEET NO. 1 OF 2	
THIS DRAWING CONTAINS INFORMATION THAT IS PROPRIETARY TO MOLEX INCORPORATED AND SHOULD NOT BE USED WITHOUT WRITTEN PERMISSION							

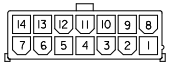

CKT. SIZE 14

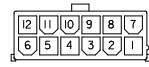

CKT. SIZE 12

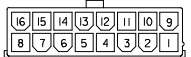

CKT. SIZE 16



CKT. SIZE 10

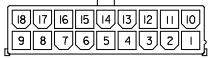

CKT. SIZE 18



CKT. SIZE 8

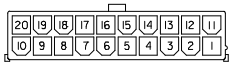

CKT. SIZE 20



CKT. SIZE 6

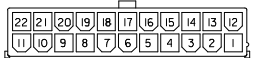

CKT. SIZE 22



CKT. SIZE 4

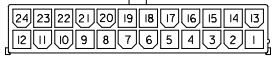

CKT. SIZE 24



CKT. SIZE 2

SEE NOTE $\Delta/5$ ON SHEET 1 FOR PLATING DETAILS

51.60±0.55	46.20	36633-0029	24	
47.40±0.55	42.00	36633-0028	22	
43.20±0.50	37.80	36633-0027	20	
39.00±0.45	33.60	36633-0039	18	
34.80±0.35	29.40	36633-0026	16	
30.60±0.30	25.20	36633-0038	14	
26.40±0.30	21.00	36633-0037	12	
22.20±0.30	16.80	36633-0025	10	
18.00±0.30	12.60	36633-0036	8	
13.80±0.25	8.40	36633-0035	6	
9.60±0.25	4.20	36633-0034	4	
5.40±0.20	--	36633-0033	2	
PIN	B	A	ENG. NO.	CKT. SIZE

TABLE 'X'

51.60±0.55	46.20	87427-244*	24
47.40±0.55	42.00	87427-224*	22
43.20±0.50	37.80	87427-204*	20
39.00±0.45	33.60	87427-184*	18
34.80±0.35	29.40	87427-164*	16
30.60±0.30	25.20	87427-144*	14
26.40±0.30	21.00	87427-124*	12
22.20±0.30	16.80	87427-104*	10
18.00±0.30	12.60	87427-084*	8
13.80±0.25	8.40	87427-064*	6
9.60±0.25	4.20	87427-044*	4
5.40±0.20	--	87427-024*	2
B	A	ENG. NO.	CKT. SIZE

ENTER DESCRIPTION EC NO: I2009-0573 DRWN: HMR01 2009/11/11 CHKD: KPRASAD 2009/11/12 APPR: KPRASAD 2009/11/13	QUALITY SYMBOLS ▽=0 ◻=0	GENERAL TOLERANCES (UNLESS SPECIFIED) mm INCH 4 PLACES ± --- ± --- 3 PLACES ± --- ± --- 2 PLACES ± 0.20 ± --- 1 PLACE ± --- ± --- ANGULAR ± ---°	DIMENSION STYLE MM ONLY DRAWN BY DATE SAM.C 960415 CHECKED BY DATE APPROVED BY DATE	SCALE --- DESIGN UNITS METRIC THIRD ANGLE PROJECTION	TITLE 4.2MM W-T-B HIGH TEMP VERT. HEADER W/O FLANGES
	MATERIAL NO. SEE CHART DOCUMENT NO. SD-87427-***4* SHEET NO. 2 OF 2	MOLEX INCORPORATED			
	DRAFT WHERE APPLICABLE MUST REMAIN WITHIN DIMENSIONS				
	THIS DRAWING CONTAINS INFORMATION THAT IS PROPRIETARY TO MOLEX INCORPORATED AND SHOULD NOT BE USED WITHOUT WRITTEN PERMISSION				