

Q45X Series Sensors

Photoelectric sensors with expansion slot for field upgrades

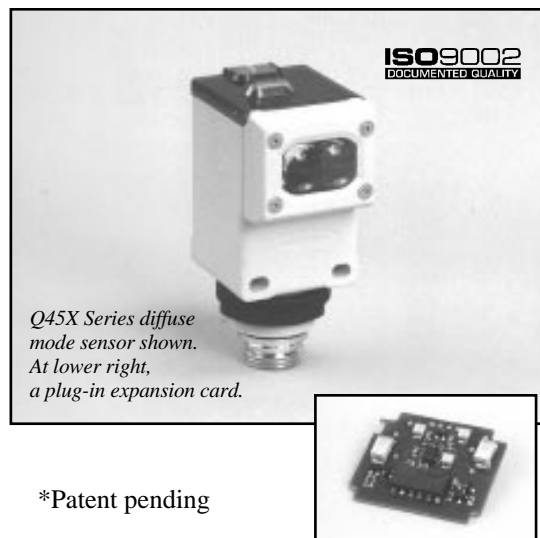

- Low cost photoelectric sensors with unique expansion slot to allow instant sensor upgrading at any time*
- Expansion cards for data bus network interfaces and sensor performance displays
- Basic sensor directly interfaces to PLCs, relays, and other logic-level loads
- Easy "smart sensor" interfacing to any data bus network by simply selecting the appropriate plug-in card and cable for popular bus protocols, including DeviceNet™, SDS™, Seriplex™, ASI™, LON™, and others.
- 10 to 30V dc operation; integral mini-style quick-disconnect (QD) connector
- Highly-visible sensor status and performance LEDs
- Tough mechanical design withstands 1200 psi washdown



Q45X Series diffuse mode sensor shown. At lower right, a plug-in expansion card.

*Patent pending

Description

Q45X Series sensors are self-contained dc photoelectric devices designed for reliable sensing in industrial environments. A unique design allows the user to instantly customize the basic sensor with the addition of one of many optional expansion cards.

Expansion cards will be available for conversion of the basic sensor to nearly any data bus system protocol. Sensors are easily converted to bus-compatible devices by simply raising the hinged top cover and plugging the appropriate bus card into the expansion slot. Bus system expansion cards are currently planned for DeviceNet™, SDS™, Seriplex™, ASI™, LON™, and others.

With the bus card installed in the Q45X, "smart drop" junction boxes are not required. Sensor wiring is accomplished using simple "dumb drop" junction boxes or "T" connectors. If the bus protocol is ever changed, the Q45X Series sensors on the network can be quickly converted by simply inserting a different bus card. Sensors are reconfigured without disturbing mounting or alignment.

The expansion slot also allows numerous advanced sensor features to be added to the basic Q45X, including sensor diagnostics and digital bargraph displays. In addition, other advanced functions can be developed to meet specific customer requirements.

The Q45X is a 10 to 30V dc sensor with impressive optical performance. Output of the basic sensor (i. e. without a bus card) is bipolar: one sourcing (PNP) and one sinking (NPN) solid-state device. Both outputs have 250 mA capacity, and may be used simultaneously. Outputs are converted from light operate (normally open) to dark operate (normally closed) via a switch located under the hinged top cover. This basic output configuration provides a direct interface to a PLC or to any "smart drop" on a bus system (see page 5).

Standard Q45X features include three highly-visible sensor status indicator LEDs for power, signal, and output state. The POWER LED flashes to indicate an overload or short circuit of either output. The SIGNAL LED incorporates Banner's patented Alignment Indicating Device (AID™) circuitry which pulses the indicator at a rate which is proportional to the received light signal strength. A slow flash rate alerts personnel to a marginal signal due to sensor misalignment or dirt on the lenses.

Q45X sensors are available for the nine sensing modes listed in the table (left). All models boast o-ring sealing which exceeds the NEMA 6P (IP67) rating. The Q45X is designed to withstand wash-downs to 1200 psi. Q45Xs are extremely rugged, with VALOX® housings and molded acrylic lenses. Mini-style quick disconnect (QD) fittings are standard, and allow the user to choose mating 5-wire cable to exactly fit the interfacing requirements (see pages 5 and 6).

VALOX® and Lexan® are registered trademarks of General Electric Co. Alignment Indicating Device system (AID™), US patent no. 4356393

Model No.	Part No.	Sensing Mode	Beam	Sensing Range
Q45X6EQ	37879	Opposed emitter	Infrared,	200 feet
Q45X6RQ	37880	Opposed receiver	880 nm	(60 m)
Q45XB6LVQ	37881	Retroreflective	Vis. red, 680 nm	30 ft. (9 m)
Q45XB6LPQ	37882	Polarized retro	Vis. red, 680 nm	20 ft. (6 m)
Q45XB6DQ	37883	Short-range diffuse	Infrared, 880 nm	18 in. (45 cm)
Q45XB6DLQ	37884	Long-range diffuse	Infrared, 880 nm	6 ft. (1,8 m)
Q45XB6CVQ	37885	Convergent	Vis. red, 680 nm	1.5 in. (38 mm)
Q45XB6CV4Q	37886	Convergent	Vis. red, 680 nm	4 in. (100 mm)
Q45XB6FQ	37887	Glass fiber optic	Infrared, 880 nm	(see page 4)
Q45XB6FPQ	37888	Plastic fiber optic	Vis. red, 660 nm	(see page 4)

Q45X Series

Specifications

SUPPLY VOLTAGE: 10 to 30V dc (10% maximum ripple), at less than 50 mA (exclusive of load).

OUTPUT CONFIGURATION:

Basic sensor output: Bipolar; one current sinking (NPN) and one current sourcing (PNP) open-collector transistor.

With optional bus card in expansion slot: Two-wire datacom interface with protocol corresponding to the bus system which is supported by the expansion board in use. Bus cards are planned for Device Net™, SDS™, Seriplex™, ASI™, LON™, and others.

OUTPUT RATING (for basic sensor configuration, no bus card in use): 250 mA maximum (each output) up to 50°C, derated to 150 mA at 70°C (derate 5 mA/°C). Output leakage < 1 μA (off state). Output saturation voltage (both outputs) < 1V at 10 mA and < 2 V at 250 mA. Both outputs are protected against continuous overload or short circuit when the sensor is in the basic configuration.

CIRCUITRY PROTECTION: Sensors are protected against false pulse upon power-up and false response to power supply transients. Sensors are protected from power supply polarity reversal.

RESPONSE TIME and REPEATABILITY: Independent of signal strength. See individual sensor specifications (pages 3 & 4). 100 millisecond delay upon power-up (outputs are inactive during this period).

ADJUSTMENTS: Multi-turn SENSITIVITY control on top of sensor (beneath a transparent o-ring sealed Lexan® cover) allows precise sensitivity setting (turn clockwise to increase gain). Internal switch selects LIGHT operate (L/O) or DARK operate (D/O).

STATUS INDICATORS: Highly visible; located beneath a transparent Lexan® dome on top of the sensor.

POWER: Green LED lights whenever 10 to 30V dc power is applied, and flashes to indicate output overload or short circuit.

SIGNAL: Patented Alignment Indicating Device (AID™) System red LED pulses at a rate proportional to the strength of the received light signal. An LED bargraph indicator is available on an optional expansion card for continuous monitoring of signal level and sensing contrast.

LOAD: Yellow LED lights whenever the outputs are conducting.

CONSTRUCTION: Molded VALOX® thermoplastic polyester housing. Molded acrylic lenses. Stainless steel hardware. O-ring sealed transparent Lexan® top cover. NEMA 6P (IEC IP 67) rated. Designed to withstand 1200 psi washdown (except cable connection).

CABLE: Sensors require mini-style quick disconnect cable, sold separately. See page 5 for details.

MOUNTING OPTIONS: Standard industrial limit switch mounting via two #10 (5 mm) screw clearance holes on 30 mm centers (see dimension drawing, above right). Brackets are available for mounting sensor by its 30 mm threaded base (mounting jam nut is included with sensor). See page 6 and the Banner Product Catalog for a selection of 30 mm brackets.

OPERATING TEMPERATURE: -40 to +70°C (-40 to +158°F).

Dimensions

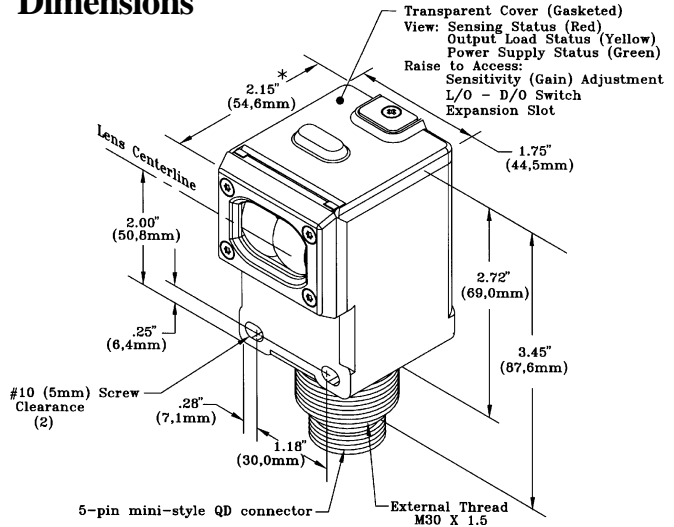

NOTES FOR DIMENSIONS

*2.15" (54,6 mm) is the depth dimension for sensors with the following suffixes: E (emitter), D (short-range diffuse), DL (long-range diffuse), LV (retroreflective), and R (receiver).

The sensor depth dimension for other models is as follows:

CV and CV4 (convergent): 2.42" (61,5 mm)

LP (polarized retroreflective): 2.30" (56,4 mm)

F (glass fiber optic): 2.38" (60,5 mm)

FP (plastic fiber optic): 2.35" (59,8 mm)

Emitters ("E" model suffix) have the green power status LED only, and no internal adjustments.

A 30 mm jam nut is supplied for mounting the sensor via its threaded base.

Functional Schematics

Basic Configuration (bus card not installed)

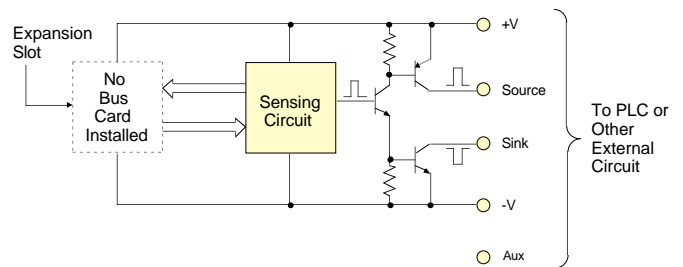

Bus Configuration (bus card installed)

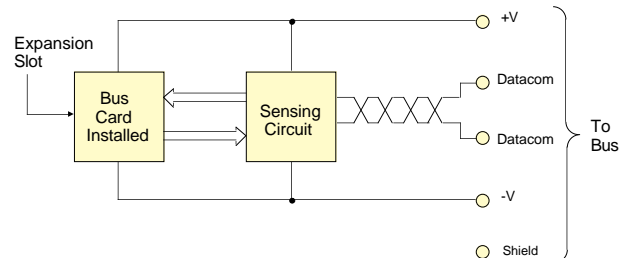

Q45X Series Optical Performance

Sensing Mode and Models

Excess Gain

Beam Pattern

OPPOSED Mode



Q45X6EQ emitter Q45XB6RQ rcvr

Range: 200 feet (60m)
Beam: infrared, 880nm
Response: 2 ms on/1 ms off
Repeatability: .25 ms

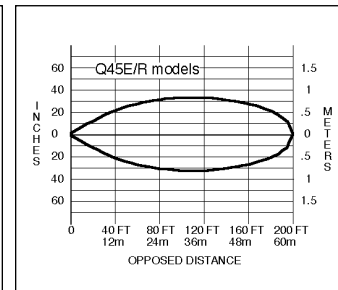
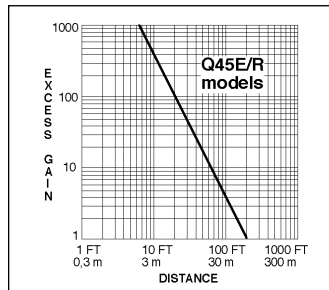
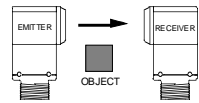

SHORT-RANGE DIFFUSE (PROXIMITY) Mode



Q45XB6DQ

Range: 18 inches (45cm)
Beam: infrared, 880nm
Response: 2 ms on/off
Repeatability: .5 ms

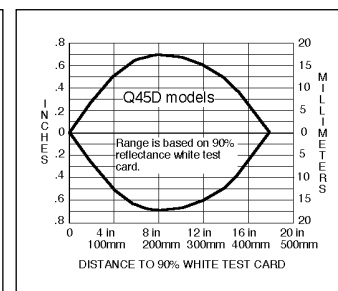
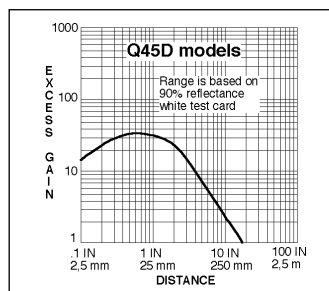
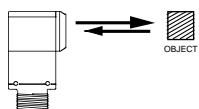

LONG-RANGE DIFFUSE (PROXIMITY) Mode

Diffuse (proximity) mode sensors detect objects by sensing their own emitted light reflected from the object. They are ideal for use when the reflectivity and profile of the object to be detected are sufficient to return a large percentage of emitted light back to the sensor. Model Q45XB6DLQ is the first choice for diffuse (proximity) mode applications when there are no background objects to falsely return light.

Q45XB6DLQ

Range: 6 feet (1.8 m)
Beam: infrared, 880nm
Response: 2 ms on/off
Repeatability: .5 ms

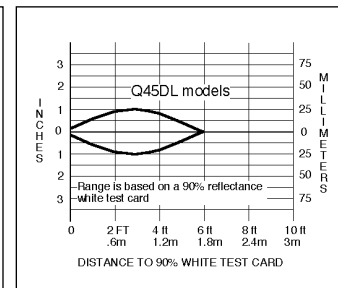
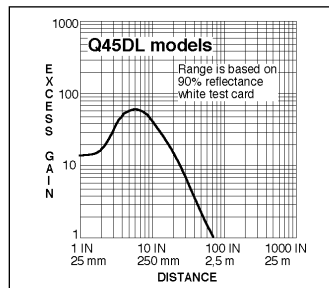

RETROREFLECTIVE Mode



Q45XB6LVQ

Range: 3 inches to 30 feet
(0,08 to 9m²)
Beam: visible red, 680nm
Response: 2 ms on/off
Repeatability: .5 ms
†with BRT-3 reflector

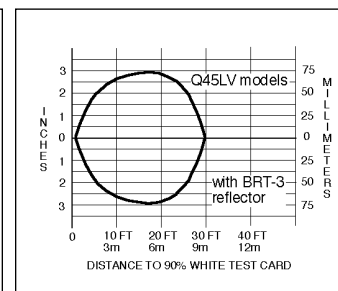
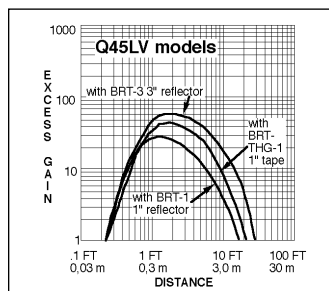
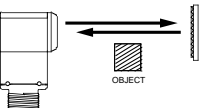

POLARIZED RETRO Mode

The *visible red sensing beam* of these sensors makes them very easy to align.

Model Q45XB6LPQ polarizes the emitted light and filters out unwanted reflections, making sensing possible in applications otherwise considered unsuited to retroreflective sensing. Use "LPs" only in very clean environments, and use with the model BRT-3 3" reflector. NOTE: for detailed information on retroreflective targets, see the Banner product catalog.

Q45XB6LPQ

Range: 6 inches to 20 feet
(0,15 to 6 m²)
Beam: visible red, 680nm
Response: 2 ms on/off
Repeatability: .5 ms

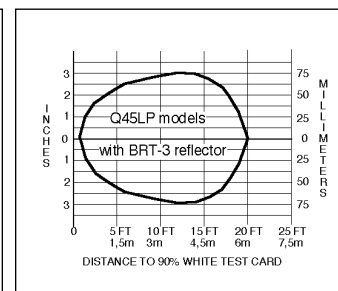
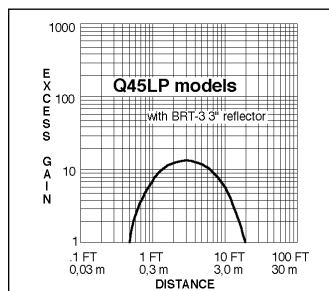

Q45X Series Optical Performance

Sensing Mode and Models

Excess Gain

Beam Pattern

CONVERGENT Mode



Q45XB6CVQ and Q45XB6CV4Q

Ranges:
 CV focus at 1.5 in. (38 mm);
 .2" diameter sensing spot
 CV4 focus at 4 in. (100 mm);
 .4" diameter sensing spot
Beam: visible red, 680nm
Response: 2ms on/off
Repeatability: .5ms

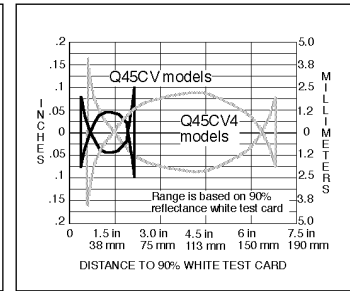
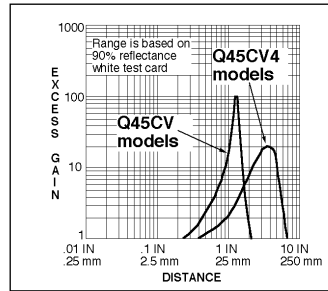
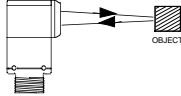

FIBER OPTIC Mode (glass fibers)

Q45XB6FQ

Range: see excess gain curves
Beam: infrared, 880nm
Response: 2 ms on/off
Repeatability: .5 ms

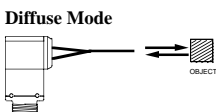
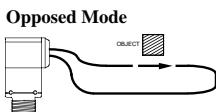

Model Q45XB6FQ has high excess gain (72" range with IT23S fibers). As a result, opposed individual fibers operate reliably in many very hostile environments. Also, special miniature bifurcated fiber optic assemblies with bundle sizes as small as .020 inch (.5mm) in diameter may be used successfully for diffuse mode sensing. The excess gain curves and beam patterns illustrate response with standard .060 inch (1.5mm) diameter and .12 inch (3mm) diameter bundles. Response for smaller or larger bundle sizes may be interpolated.

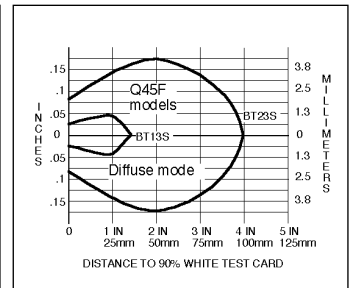
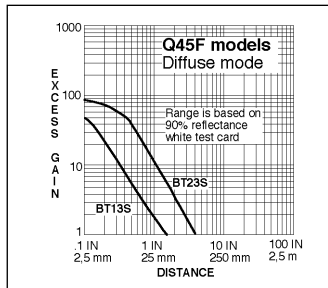
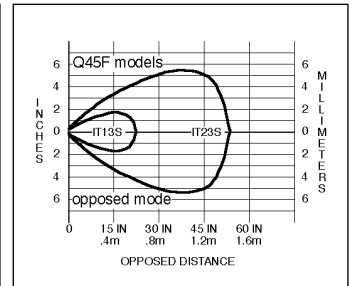
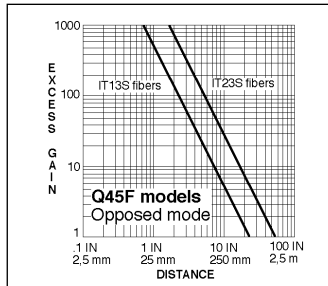

FIBER OPTIC Mode (plastic fibers)

Q45XB6FPQ

Range: see excess gain curves
Beam: visible red, 660nm
Response: 2 ms on/off
Repeatability: .5 ms

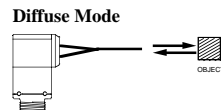
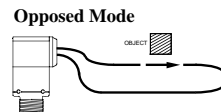

Plastic fiber optics are lower in cost than glass fiber optics, and are ideal for use in situations where environmental conditions allow (see information, below). They are easily cut to length in the field, and are available in a variety of sensing end styles. For further information, refer to the Banner product catalog.

ENVIRONMENTAL FACTORS FOR PLASTIC FIBER OPTICS

OPERATING TEMPERATURE OF PLASTIC FIBER OPTIC ASSEMBLIES: -30 to +70 degrees C (-20 to +158 degrees F).

CHEMICAL RESISTANCE OF PLASTIC FIBER OPTIC ASSEMBLIES: the acrylic core of the monofilament optical fiber will be damaged by contact with acids, strong bases (alkalis), and solvents. The polyethylene jacket will protect the optical fiber from most chemical environments; however, materials

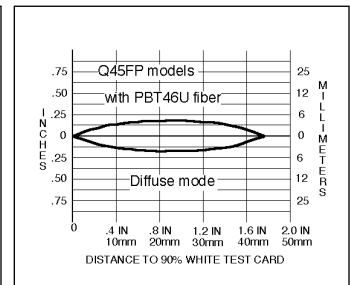
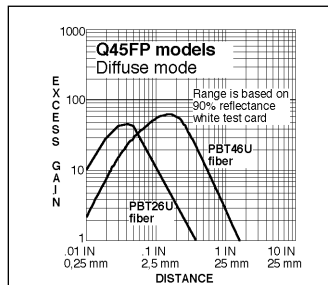
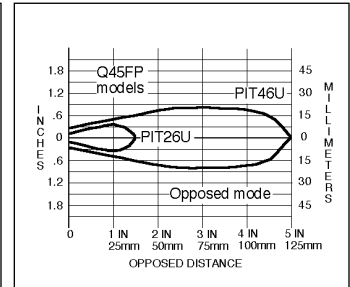
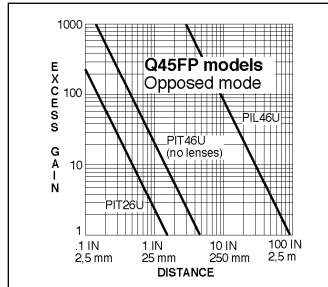

may migrate through the jacket with long-term exposure. Samples of plastic fiberoptic material are available from Banner for testing and evaluation.

Quick-disconnect Cable

(model MBCC-512 cable for basic sensor hookup only*)

All Q45X sensor models in basic hookup (base, male connector):

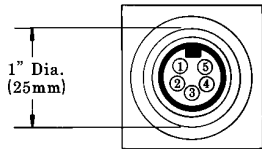

Mating mini-style cable (MBCC-512); all Q45X sensor models in basic hookup, female plug:

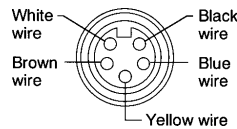

Cable model and part number:

MBCC-512 p/n 25496

NOTE: MBCC Series mini-style cables for Q45X Series sensors are 12 feet in length, and must be ordered separately from the sensor. Thirty-foot cables are also available.

*Not for bus network hookup. See page 5.

Mounting Brackets

Accessory mounting bracket model **SMB30S** (33204) is a swivel mount bracket whose swivel ball locks in place when its two clamping bolts are tightened. Bracket material is black VALOX®. Hardware

is stainless steel, and mounting bolts are included. This bracket may be used with Q45s and other sensors having M30 x 1.5 threads. Bracket dimensions are given below.

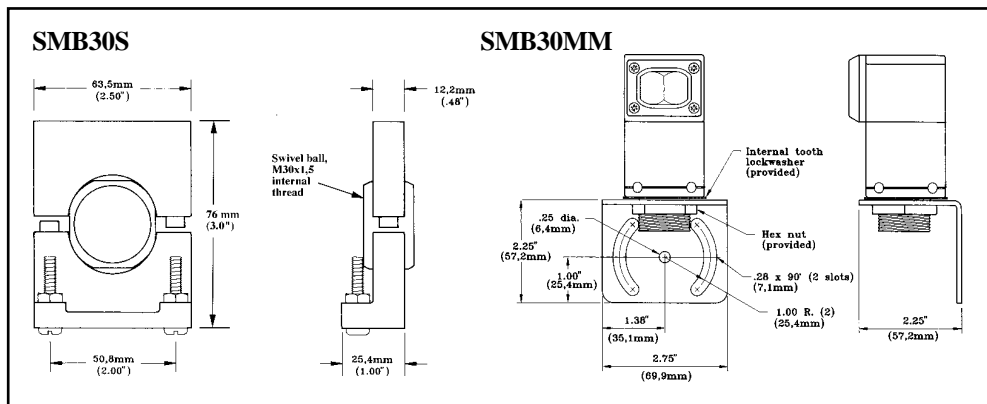

Model **SMB30C** (32636) split clamp bracket is similar, but without the adjustable swivel ball. Bracket material is black VALOX®.

Mounting bracket **SMB30MM** (27162) has curved mounting slots for versatility in mounting and orientation.

The sensor mounts to the SMB30MM by its threaded base, using a jam nut and lock washer (supplied).

The curved mounting slots have clearance for 1/4-inch hardware. Dimensions are given at the left.



WARNING These photoelectric presence sensors do NOT include the self-checking redundant circuitry necessary to allow their use in personnel safety applications. A sensor failure or malfunction can result in either an energized or a de-energized sensor output condition.

Never use these products as sensing devices for personnel protection. Their use as safety devices may create an unsafe condition which could lead to serious injury or death.

Only MACHINE-GUARD and PERIMETER-GUARD Systems, and other systems so designated, are designed to meet OSHA and ANSI machine safety standards for point-of-operation guarding devices. No other Banner sensors or controls are designed to meet these standards, and they must NOT be used as sensing devices for personnel protection.

WARRANTY: Banner Engineering Corporation warrants its products to be free from defects for one year. Banner Engineering Corporation will repair or replace, free of charge, any product of its manufacture found to be defective at the time it is returned to the factory during the warranty period. This warranty does not cover damage or liability for the improper application of Banner products. This warranty is in lieu of any other warranty either expressed or implied.