



L78LR05

150mA, 5V 5-Pin Voltage Regulator with Reset Function

Overview

The L78LR05 is voltage regulator IC that performs the reset signal generating function when the power supply of a microcomputer system is turned ON/OFF. The L78LR05 is convenient for battery backup system at the time of power failure. The reset threshold voltage V_{RT} is ranked as shown below.

V_{RT} rank	B	C	D	E	F	G	H
V_{RT} (V)	4.8	4.5	4.2	3.9	3.6	3.3	3.0

Applications

- Prevention of malfunction that may occur when the power supply of a microcomputer is turned ON/OFF.
- Measures taken against abnormal operations that may occur at the time of instantaneous break of power supply.
- Direct battery backup for SRAM.

Features

- 5V, 150mA output.
- Capable of generating a microcomputer reset signal.
- No battery-regulator switching circuit required at the battery backup mode (Output leakage current : $2\mu\text{A}$ or less).
- An external capacitor can be used to set the reset output delay time.
- Applicable to the power supply of CMOS, NMOS microcomputers.
- Especially suited for use as an on-board regulator for a microcomputer system.
- Small-sized power package TP-5H permitting the equipment to be made compact.
- The allowable power dissipation can be increased by being surface-mounted on the board.
- Capable of being mounted in a variety of methods because of various lead forming versions available.
- On-chip protectors (overcurrent limiter, ASO protector, thermal protector).

Package Dimensions

unit:mm

3103

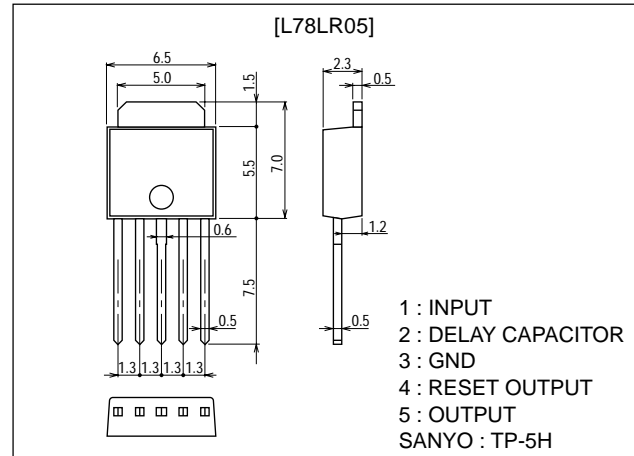

■ Any and all SANYO products described or contained herein do not have specifications that can handle applications that require extremely high levels of reliability, such as life-support systems, aircraft's control systems, or other applications whose failure can be reasonably expected to result in serious physical and/or material damage. Consult with your SANYO representative nearest you before using any SANYO products described or contained herein in such applications.

■ SANYO assumes no responsibility for equipment failures that result from using products at values that exceed, even momentarily, rated values (such as maximum ratings, operating condition ranges, or other parameters) listed in products specifications of any and all SANYO products described or contained herein.

L78LR05

Specifications

Maximum Ratings at $T_a = 25^\circ\text{C}$

Parameter	Symbol	Conditions	Ratings	Unit
Maximum Input Voltage	$V_{IN\text{ max}}$		25	V
Allowable Power Dissipation	$P_d\text{ max}$	(No fin)	1.0	W
Operating Temperature	T_{opr}		-30 to +80	$^\circ\text{C}$
Storage Temperature	T_{stg}		-55 to +150	$^\circ\text{C}$

Operating Conditions at $T_a = 25^\circ\text{C}$

Parameter	Symbol	Conditions	Ratings	Unit
Input Voltage	V_{IN}		7.5 to 20	V
Output Current	I_{OUT}		1 to 150	mA

Operating Characteristics at $T_a = 25^\circ\text{C}$, $V_{IN}=10\text{V}$, $I_{OUT}=40\text{mA}$, $c_{in}=1\mu\text{F}$, $c_o=10\mu\text{F}$

Parameter	Symbol	Conditions	Ratings			Unit
			min	typ	max	
Output Voltage	V_{OUT1}	$T_j=25^\circ\text{C}$	4.8	5.0	5.2	V
	V_{OUT2}	$7\text{V}\leq V_{IN}\leq 20\text{V}$, $1\text{mA}\leq I_{OUT}\leq 70\text{mA}$	4.75		5.25	V
Line Regulation	$\Delta V_o\text{ LINE1}$	$T_j=25^\circ\text{C}$, $7\text{V}\leq V_{IN}\leq 20\text{V}$		6.0	75	mV
	$\Delta V_o\text{ LINE2}$	$T_j=25^\circ\text{C}$, $8\text{V}\leq V_{IN}\leq 20\text{V}$		3.0	50	mV
Load Regulation	$\Delta V_o\text{ LOAD1}$	$T_j=25^\circ\text{C}$, $1\text{mA}\leq I_{OUT}\leq 100\text{mA}$		9.0	60	mV
	$\Delta V_o\text{ LOAD2}$	$T_j=25^\circ\text{C}$, $1\text{mA}\leq I_{OUT}\leq 40\text{mA}$		3.0	30	mV
Current Dissipation	I_{CC}	$T_j=25^\circ\text{C}$, $I_{OUT}=100\text{mA}$		1.4	3.4	mA
Current Dissipation Variation	$\Delta I_{CC}\text{ LINE}$	$8\text{V}\leq V_{IN}\leq 20\text{V}$		0.12	1.5	mA
	$\Delta I_{CC}\text{ LOAD}$	$1\text{mA}\leq I_{OUT}\leq 40\text{mA}$		0.01	0.1	mA
Output Noise Voltage	V_{NO}	$10\text{Hz}\leq f\leq 100\text{kHz}$, $I_o=1\text{mA}$		80		μV
Temperature Coefficient of Output Voltage	$\Delta V_{OUT}/\Delta T_j$	$I_{OUT}=1\text{mA}$, $T_j=25$ to 125°C		± 0.5		$\text{mV}/^\circ\text{C}$
Ripple Rejection	R_{rej}	$T_j=25^\circ\text{C}$, $f=120\text{Hz}$, $8\text{V}\leq V_{IN}\leq 18\text{V}$		79		dB
Dropout Voltage	V_{DROP}	$T_j=25^\circ\text{C}$		1.5	2.2	V
Output Short Current	I_{OSC}	$T_j=25^\circ\text{C}$	150	300	450	mA
"H"-Reset Output Voltage	V_{ORH}	$T_j=25^\circ\text{C}$	4.8	5.0	5.2	V
"L"-Reset Output Voltage	V_{ORL}	$T_j=25^\circ\text{C}$, $V_{IN}=3\text{V}$, $I_o=1\text{mA}$		10	200	mV
Reset Threshold Voltage	V_{RT}	B, $T_j=25^\circ\text{C}$	4.60	4.8	4.95	V
		C, $T_j=25^\circ\text{C}$	4.30	4.5	4.65	V
		D, $T_j=25^\circ\text{C}$	4.00	4.2	4.35	V
		E, $T_j=25^\circ\text{C}$	3.70	3.9	4.05	V
		F, $T_j=25^\circ\text{C}$	3.40	3.6	3.75	V
		G, $T_j=25^\circ\text{C}$	3.10	3.3	3.45	V
		H, $T_j=25^\circ\text{C}$	2.80	3.0	3.15	V
		Reset Threshold Hysteresis Voltage	V_{RTH}		50	100
Reset Output Delay Time	t_d	$c_d=0.1\mu\text{F}$	7.5	10	12.5	ms
Output Pin Leakage Current	$I_{O\text{ LEAK}}$	$V_{IN}=0$, $V_o=6\text{V}$		0.001	2	μA
Reset Output Pin Leakage Current	$I_{OR\text{ LEAK}}$	$V_{IN}=0$, $V_{OR}=6\text{V}$		0.001	2	A

Equivalent Circuit Block Diagram

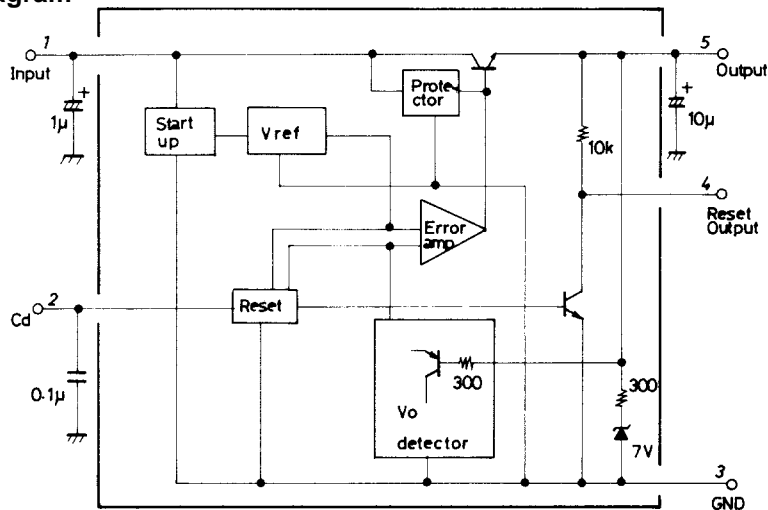

Unit (resistance: Ω , capacitance: F)

L78LR05

Sample Application Circuit 1

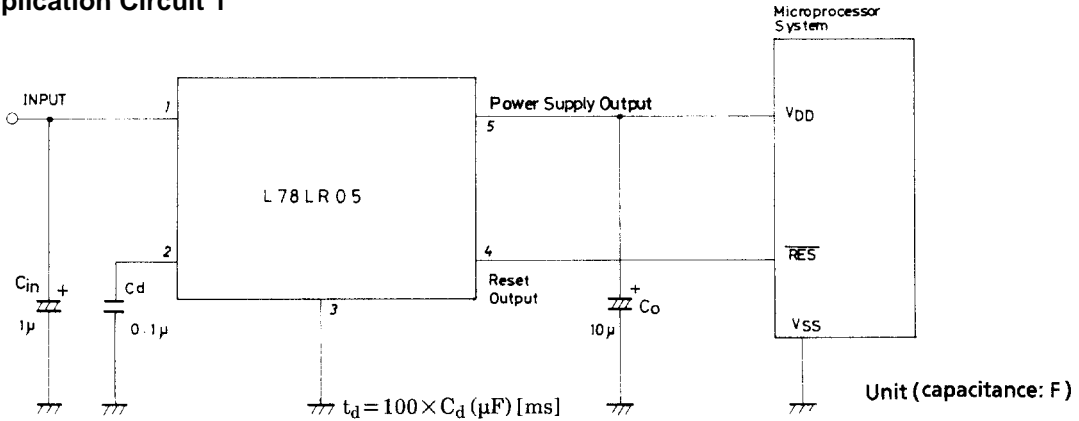

Note 1 : When the capacitance of C_d is large, the capacitor may not discharge completely, causing t_d to be made shorter than a set value. If this is a problem, either connect a high speed diode (DS442) between pin2 (anode side) and pin5 (cathode side) or ensure an adequate discharge time by using values for capacitors C_{in} and C_d such that $C_{in} > C_d$.

Note 2 : If a pull-up resistor is connected to the reset output pin externally, it is possible to cause a sink current up to 4mA to flow.

Reset Operation

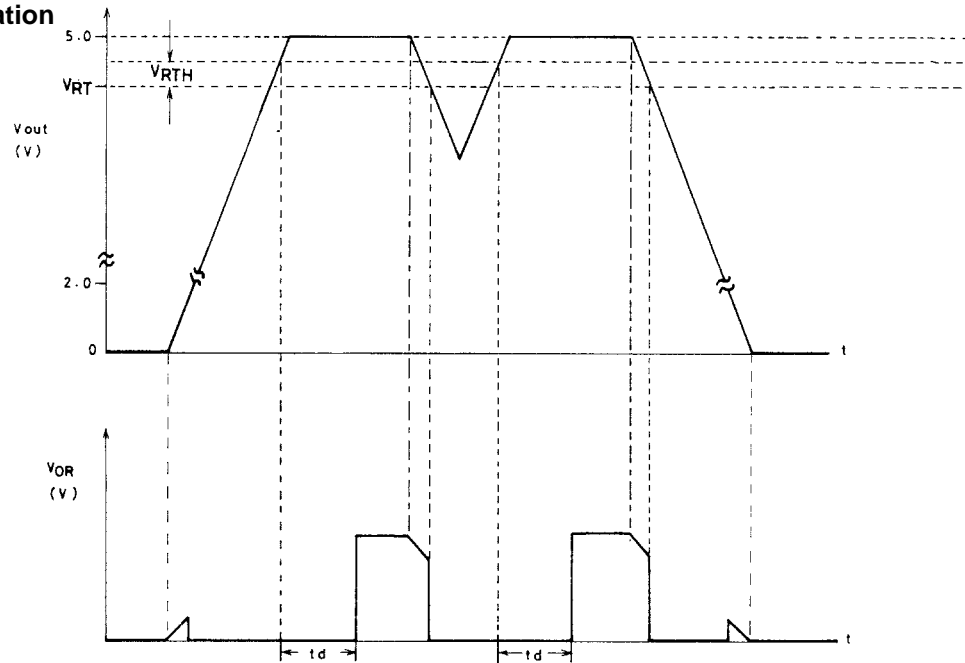

Sample Application Circuit 2 (Direct battery backup)

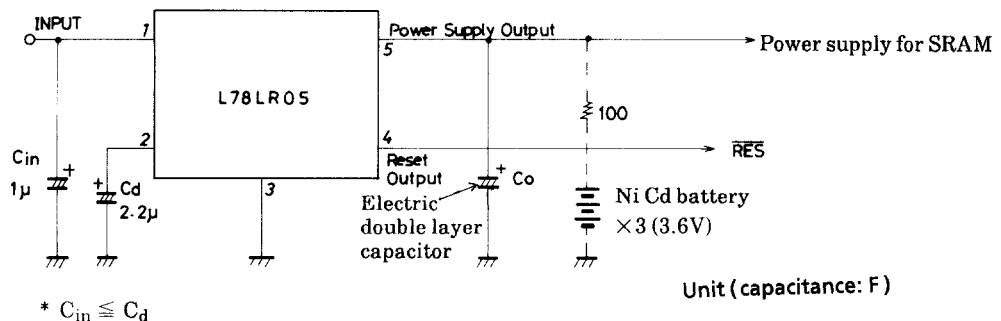

Since the leakage current at the output pin (pin5) of the L78LR05 is so low as 2µA or less, a backup circuit can be implemented by connecting an electric double layer capacitor (super capacitor : NEC, gold capacitor : Matsushita Electric) or a Ni Cd battery direct to the output pin. Since a reverse blocking diode, which has been so far connected to the output pin, is not required, a regulated power-supply voltage can be supplied to a load during the steady-state operation, without voltage drop caused by the diode and effects of temperature characteristics, current characteristics of the diode. No battery-regulator switching circuit is required at the battery backup start mode.

Note 3 : The capacitance of reset output signal delay capacitor C_d must exceed that of input capacitor C_{in} . If the capacitance of C_d is small, a reset pulse signal may be generated once when the main power source is turned off (at the battery backup start mode).

L78LR05

Allowable Power Dissipation

The allowable power dissipation is 1.0W ($T_a=25^\circ\text{C}$) with fin attached. When the L78LR05 is surface-mounted on a hybrid IC board or printed circuit board, a high allowable power dissipation can be obtained, though it is placed in a small-sized package. Shown below is the relationship between the Cu-foiled area the allowable power dissipation when the L78LR05 is surface-mounted on a glass epoxy board ($50\times 50\times 0.8\text{mm}^3$).

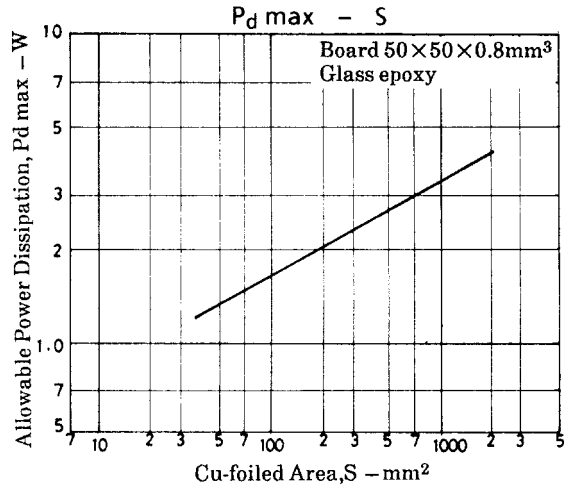
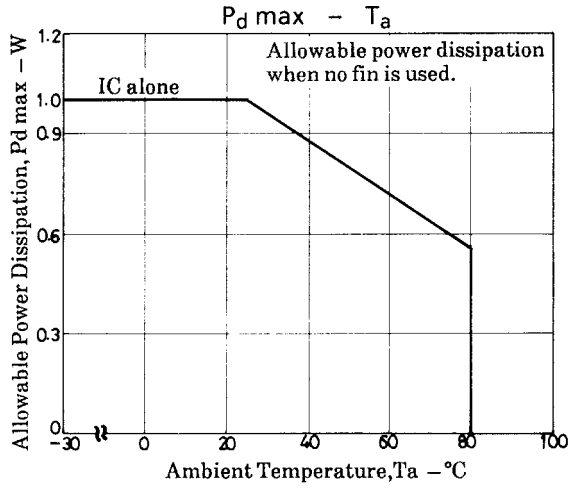

* The measured values of P_d represent the values measured when solder on the Cu-foiled area is all wet.

Lead Forming

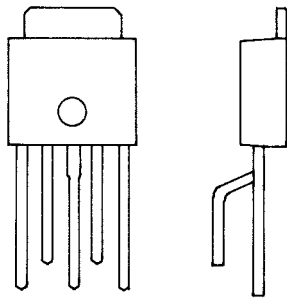

MA forming

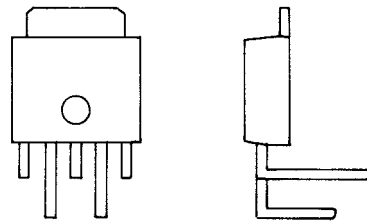

LR forming

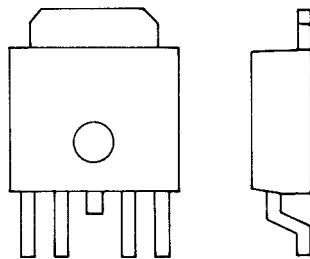

FA forming

L78LR05

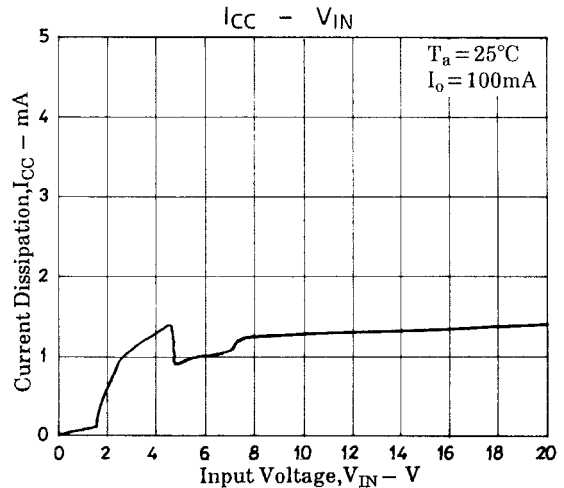
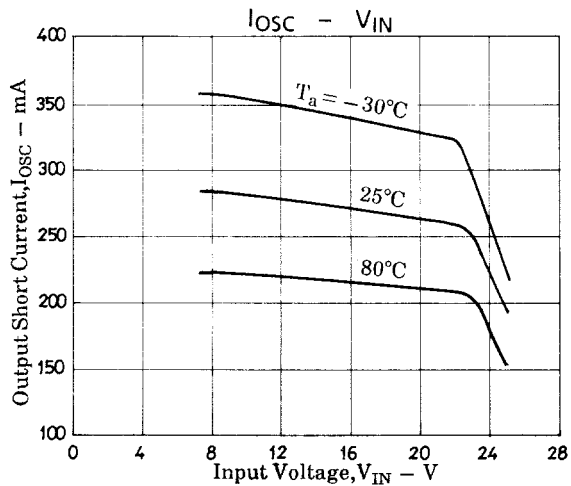
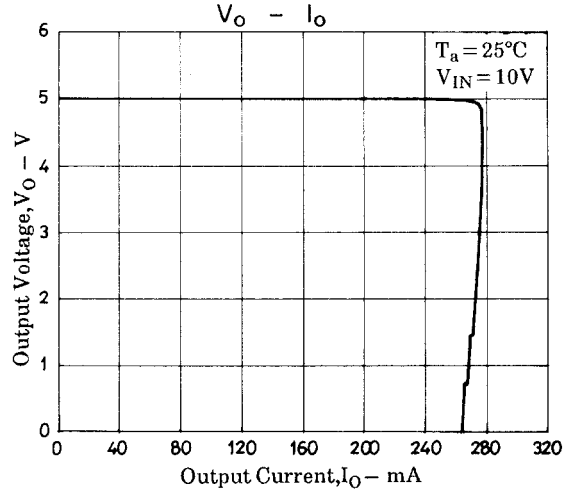
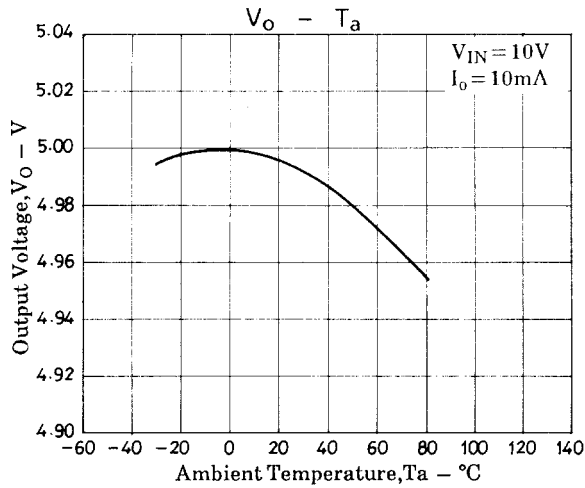
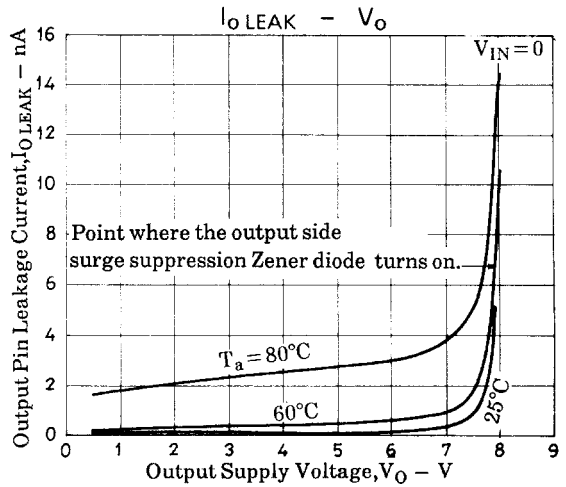
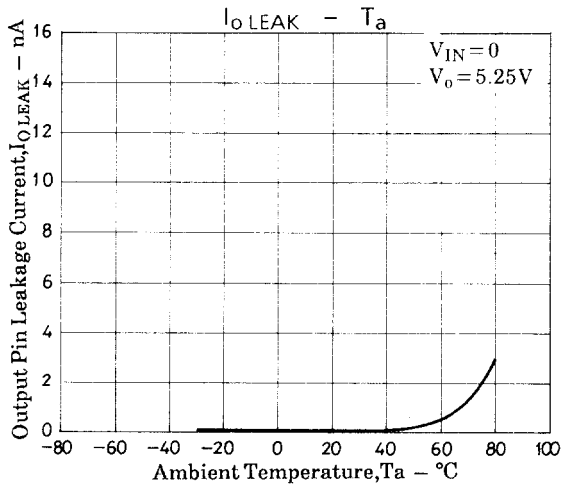
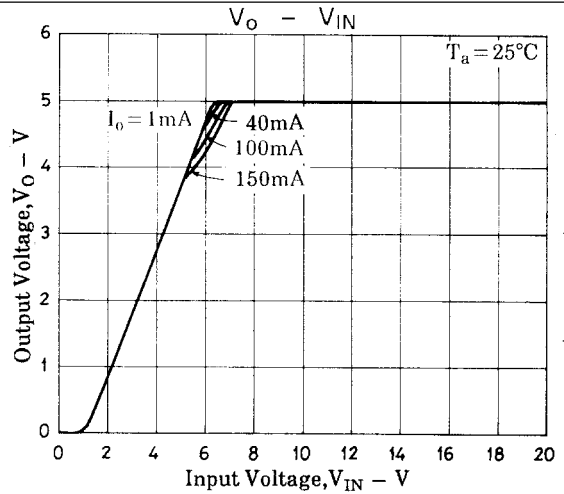
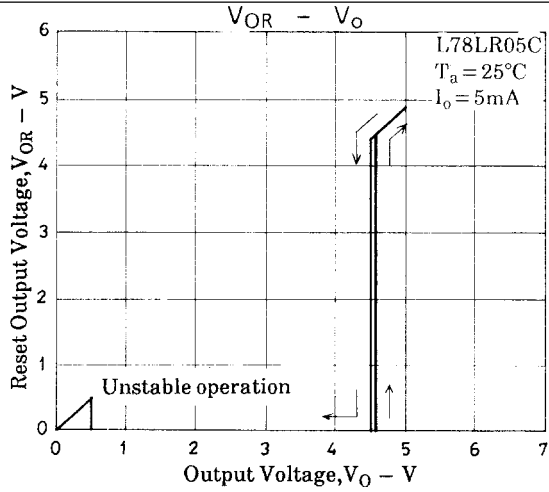

L78LR05

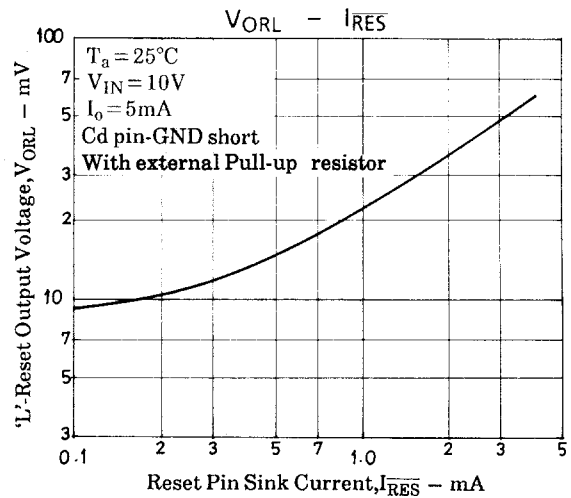
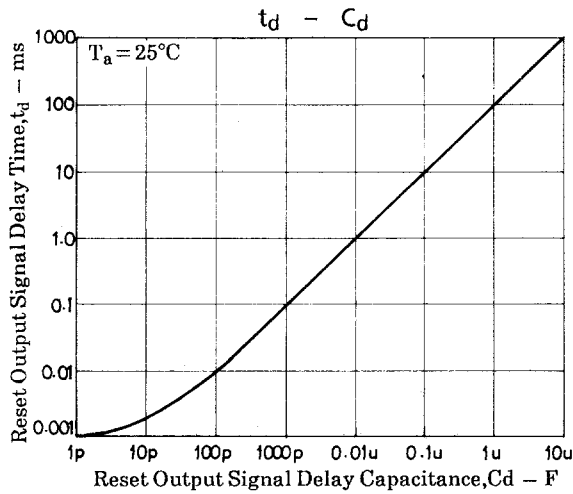
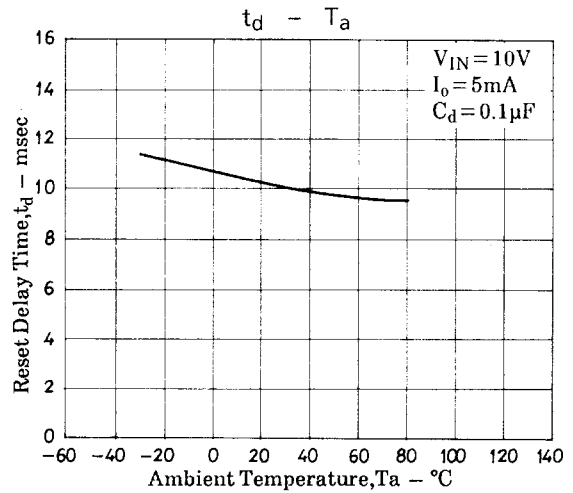
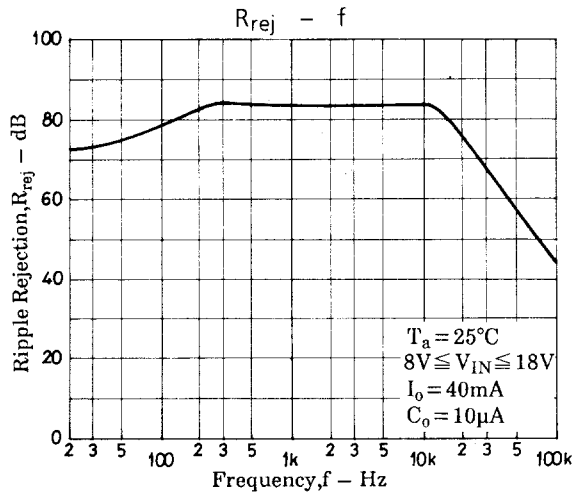

- Specifications of any and all SANYO products described or contained herein stipulate the performance, characteristics, and functions of the described products in the independent state, and are not guarantees of the performance, characteristics, and functions of the described products as mounted in the customer's products or equipment. To verify symptoms and states that cannot be evaluated in an independent device, the customer should always evaluate and test devices mounted in the customer's products or equipment.
- SANYO Electric Co., Ltd. strives to supply high-quality high-reliability products. However, any and all semiconductor products fail with some probability. It is possible that these probabilistic failures could give rise to accidents or events that could endanger human lives, that could give rise to smoke or fire, or that could cause damage to other property. When designing equipment, adopt safety measures so that these kinds of accidents or events cannot occur. Such measures include but are not limited to protective circuits and error prevention circuits for safe design, redundant design, and structural design.
- In the event that any or all SANYO products (including technical data, services) described or contained herein are controlled under any of applicable local export control laws and regulations, such products must not be exported without obtaining the export license from the authorities concerned in accordance with the above law.
- No part of this publication may be reproduced or transmitted in any form or by any means, electronic or mechanical, including photocopying and recording, or any information storage or retrieval system, or otherwise, without the prior written permission of SANYO Electric Co., Ltd.
- Any and all information described or contained herein are subject to change without notice due to product/technology improvement, etc. When designing equipment, refer to the "Delivery Specification" for the SANYO product that you intend to use.
- Information (including circuit diagrams and circuit parameters) herein is for example only; it is not guaranteed for volume production. SANYO believes information herein is accurate and reliable, but no guarantees are made or implied regarding its use or any infringements of intellectual property rights or other rights of third parties.

This catalog provides information as of December, 1999. Specifications and information herein are subject to change without notice.