

Varactor-Tuned Oscillators

Technical Data

Features

- **600 MHz to 10.5 GHz Coverage**
- **Fast Tuning**
- **+7 to +13 dBm Output Power**
- **± 1.5 dB Output Flatness**
- **Hermetic Thin-film Construction**

Description

HP VTO-8000 Series oscillators use a silicon transistor chip as a negative resistance oscillator. The oscillation frequency is determined by a silicon abrupt varactor diode acting as a voltage-variable capacitor in a thin-film microstripline resonator. This provides extremely fast tuning speed, limited primarily by the internal impedance of the user-supplied voltage driver. Fast settling is another feature of the HP VTO-8000 Series oscillators. Typical settling times for the VTO-8090 are <200 kHz within one microsecond while the VTO-8950 settles to <2 MHz within two microseconds referenced to ten milliseconds. The VTO-8850 combines a bipolar transistor oscillator with a GaAs FET buffer stage. This GaAs FET buffer isolates the oscillator from

variations in load impedance for low frequency pulling, allows the oscillator to run lightly-loaded for low phase noise content and provides +10 dBm of minimum output power over the full tuning range. The VTO-8000 Series varactor-tuned oscillators are packaged in TO-8 transistor cans for simple installation in a conventional 50-ohm microstripline PC board. They are ideal for most compact, lightweight commercial and military equipment designs. Test fixturing is also available for lab bench test applications. See the "Test Fixtures for TO-8 Packages" section for additional information and outlines.

Applications

Frequency agile systems, such as digitally controlled receivers and active jamming transmitters often use externally linearized varactor-tuned oscillators. HP oscillators are monotonic making external linearization easy using analog (opamp) or digital (EPROM) linearizing techniques. The HP VTO Series has been designed with a tuning input bypass capacitance which is sufficient to provide the necessary RF filtering action yet as low

VTO-8000 Series

Pin Configuration TO-8V

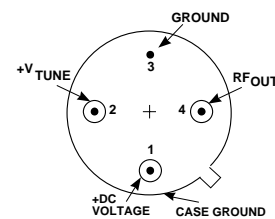

as possible to maximize $\Delta V/\Delta T$ characteristics for excellent tuning speeds. Used in a phase locked loop PLL circuit, a VTO provides a receiver LO with stability equivalent to the reference oscillator (usually crystal controlled), yet variable in discrete steps or continuously depending on the PLL configuration.

Another important aspect of VTOs used in an LO application is their power vs. frequency flatness (± 1.5 dB). This assures that once a receiver mixer is biased for best dynamic range the local oscillator drive will remain constant throughout the tuning range without complex leveling circuitry.

Electrical and Performance Specifications

Guaranteed Specifications @ 25°C Case Temperature (0° to +65°C Operating Temperature)

Part Number	VTO-8060	VTO-8080	VTO-8090	VTO-8150	VTO-8200
Frequency Range, Min.	600–1000MHz	800–1400MHz	900–1600MHz	1500–2500MHz	2000–3000MHz
Power Output into 50–ohm Load, Min.	20mW/+13dBm	20mW/+13dBm	20mW/+13dBm	10mW/+10dBm	10mW/+10dBm
Power Output Variation @ 25°C, Max.	± 1.5dB	± 1.5dB	± 1.5dB	± 1.5dB	± 1.5dB
Operating Case Temperature Range	0°to +65°C	0°to +65°C	0°to +65°C	0°to +65°C	0°to +65°C
Frequency Drift Over Operating Temperature, Typ.	8 MHz	10 MHz	10 MHz	18 MHz	30 MHz
Pulling Figure (12 dB Return Loss), Typ.	25 MHz	25 MHz	25 MHz	35 MHz	35 MHz
Pushing Figure, +15 VDC Supply, Typ.	5 MHz/V	6 MHz/V	6 MHz/V	6 MHz/V	6 MHz/V
Harmonics, Below Carrier, Typ.	-15 dB	-15 dB	-15 dB	-15 dB	-18 dB
Spurious Output Below Carrier, Min.	-60 dB	-60 dB	-60 dB	-60 dB	-60 dB
Tuning Voltage					
Low Frequency	3± 1VDC	2± 1.5VDC	2± 1VDC	2.5± 1VDC	2+2/-1VDC
High Frequency	40± 8VDC	35± 10VDC	48+8/-10VDC	47± 8VDC	20± 4VDC
Maximum Tuning Voltage	+60VDC	+60VDC	+60VDC	+60VDC	+45VDC
Tuning Port Capacitance, Nom.	180pF	180pF	180pF	90 pF	45 pF
Phase Noise, Single Sideband, 1 Hz Bandwidth, Typ.					
50 kHz From Carrier	-110 dBc/Hz	-100 dBc/Hz	-100 dBc/Hz	-95 dBc/Hz	-95 dBc/Hz
100 kHz From Carrier	-117 dBc/Hz	-107 dBc/Hz	-107 dBc/Hz	-102 dBc/Hz	-102 dBc/Hz
Input Power ± 1% Regulation					
Voltage, Nom.	+15VDC	+15VDC	+15VDC	+15VDC	+15VDC
Current, Max.	50 mA	50 mA	50 mA	50 mA	50 mA
Case Style	TO-8V	TO-8V	TO-8V	TO-8V	TO-8V

Part Number	VTO-8240	VTO-8360	VTO-8430	VTO-8580
Frequency Range, Min.	2400–3700MHz	3600–4300MHz	4300–5800MHz	5800–6600MHz
Power Output Into 50–ohm Load, Min.	10mW/+10dBm	10mW/+10dBm	10mW/+10dBm	5mW/+7 dBm
Power Output Variation @25°C., Max.	± 1.5dB	± 1.5dB	± 1.5dB	± 1.5dB
Operating Case Temperature Range	0°to +65°C	0° to +65°C	0°to +65°C	0°to +65°C
Frequency Drift Over Operating Temperature, Typ.	30 MHz	35 MHz	60 MHz	70 MHz
Pulling Figure (12 dB Return Loss), Typ.	35 MHz	40 MHz	50 MHz	70 MHz
Pushing Figure, +15 VDC Supply, Typ.	6 MHz/V	6 MHz/V	6 MHz/V	8 MHz/V
Harmonics, Below Carrier, Typ.	-18 dB	-25 dB	-25 dB	-25 dB
Spurious Output Below Carrier, Min.	-60 dB	-60 dB	-60 dB	-60 dB
Tuning Voltage				
Low Frequency	2+2/-1VDC	8± 2VDC	1.0 VDC Min	5± 2.5VDC
High Frequency	30± 8VDC	24± 4VDC	20.0VDC Max.	24+3/-5VDC
Maximum Tuning Voltage	+45VDC	+30VDC	+30VDC	+30VDC
Tuning Port Capacitance, Nom.	45 pF	45 pF	45 pF	45 pF
Phase Noise, Single Sideband, 1 Hz Bandwidth, Typ.				
50 kHz From Carrier	-95 dBc/Hz	-100 dBc/Hz	-90 dBc/Hz	-85 dBc/Hz
100 kHz From Carrier	-102 dBc/Hz	-108 dBc/Hz	-97 dBc/Hz	-92 dBc/Hz
Input Power ± 1% Regulation				
Voltage, Nom.	+15VDC	+15VDC	+15VDC	+15VDC
Current, Max.	50 mA	50 mA	50 mA	50 mA
Case Style	TO-8V	TO-8V	TO-8V	TO-8V

Electrical and Performance Specifications

Guaranteed Specifications @ 25°C Case Temperature (0° to +65°C Operating Temperature)

Part Number	VTO-8650	VTO-8810	VTO-8850	VTO-8950
Frequency Range, Min.	6500-8600MHz	8100-9100MHz	8500-9600MHz	9500-10500MHz
Power Output Into 50-ohm load, Min.	10mW/+10dBm	10mW/+10dBm	10mW/+10dBm	10mW/+10dBm
Power Output Variation @ 25°C., Max.	± 1.5dB	± 1.5dB	± 1.5dB	± 1.5dB
Operating Case Temperature Range	0° to +65°C	0° to +65°C	0° to +65°C	0° to +65°C
Frequency Drift Over Operating Temperature, Typ.	100 MHz	110 MHz	110 MHz	160 MHz
Pulling Figure (12 dB Return Loss), Typ.	15 MHz	8 MHz	10 MHz	20 MHz
Pushing Figure, +15 VDC Supply, Typ.	10 MHz/V	12 MHz/V	15 MHz/V	10 MHz/V
Harmonics, Below Carrier, Typ.	-20 dB	-15 dB	-25 dB	-20 dB
Spurious Output Below Carrier, Min.	-60 dB	-60 dB	-60 dB	-60 dB
Tuning Voltage				
Low Frequency	2± 1VDC	2 VDC Min.	5± 2VDC	4± 1VDC
High Frequency	20± 5VDC	16 VDC Max.	13± 5VDC	10 VDC Max.
Maximum Tuning Voltage	30VDC	+30VDC	+30VDC	+15VDC
Tuning Port Capacitance, Nom.	26 pF	26 pF	26 pF	26 pF
Phase Noise, Single Sideband, 1 Hz Bandwidth, Typ.				
50 kHz From Carrier	-80 dBc/Hz	-80 dBc/Hz	-82 dBc/Hz	-73 dBc/Hz
100 kHz From Carrier	-88 dBc/Hz	-88 dBc/Hz	-90 dBc/Hz	-80 dBc/Hz
Input Power ± 1% Regulation				
Voltage, Nom.	+15VDC	+15VDC	+15VDC	+15VDC
Current, Max.	50 mA	100 mA	100 mA	100 mA
Case Style	TO-8V	TO-8V	TO-8V	TO-8V

Schematic

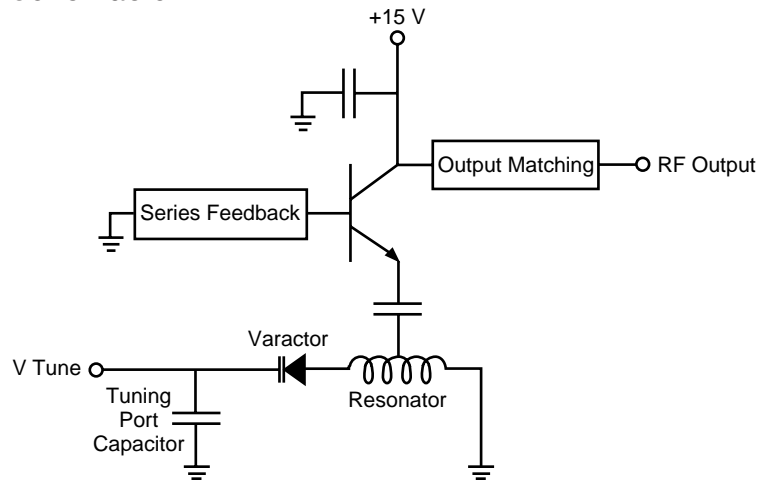

Typical Performance @ 25°C Case Temperature

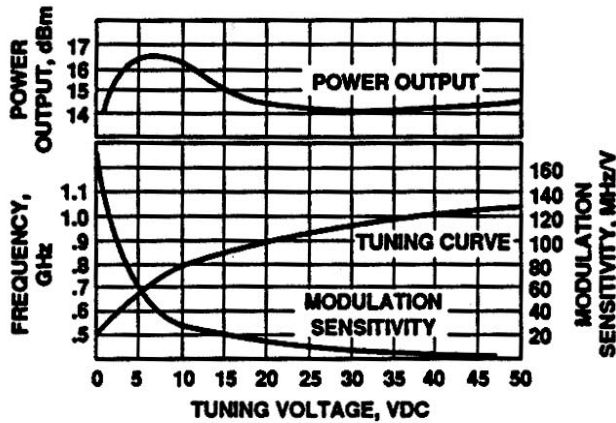

Figure 1. VTO-8060 Power Output, Frequency and Modulation Sensitivity vs. Tuning Voltage.

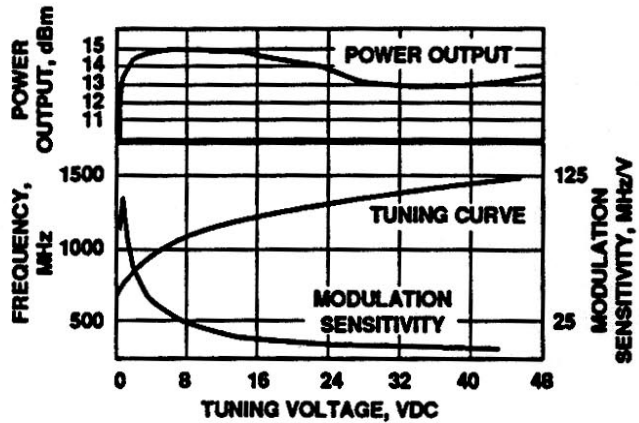

Figure 2. VTO-8080 Power Output, Frequency and Modulation Sensitivity vs. Tuning Voltage.

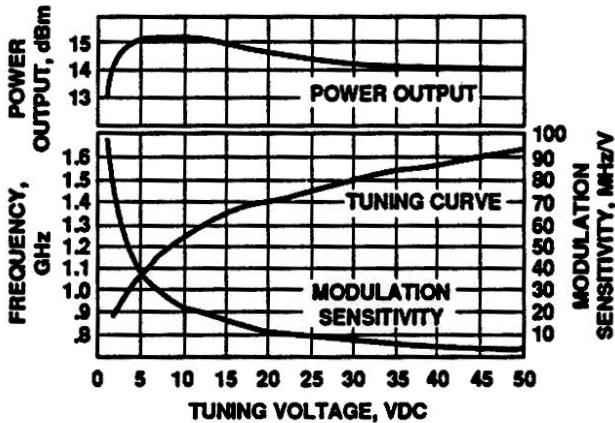

Figure 3. VTO-8090 Power Output, Frequency and Modulation Sensitivity vs. Tuning Voltage.

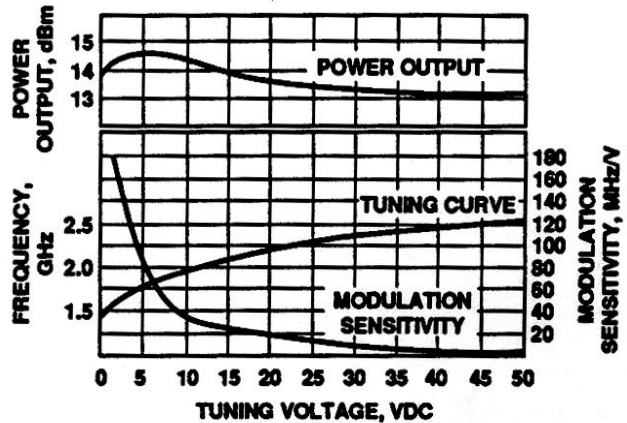

Figure 4. VTO-8150 Power Output, Frequency and Modulation Sensitivity vs. Tuning Voltage.

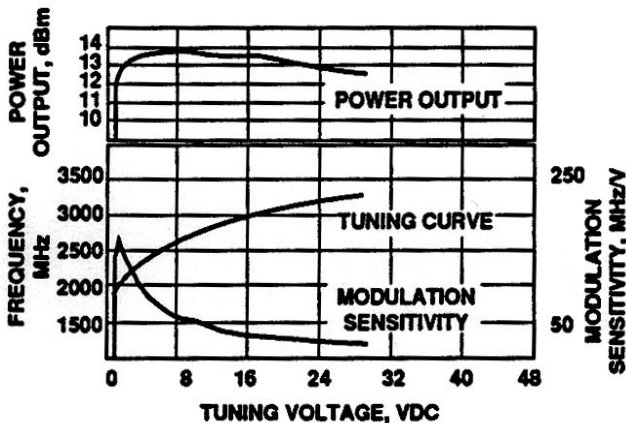

Figure 5. VTO-8200 Power Output, Frequency and Modulation Sensitivity vs. Tuning Voltage.

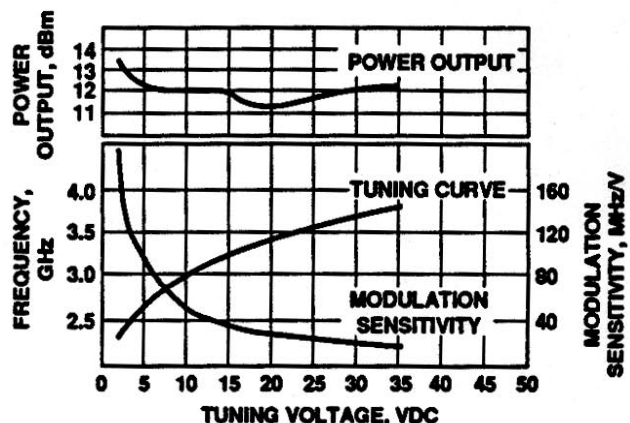

Figure 6. VTO-8240 Power Output, Frequency and Modulation Sensitivity vs. Tuning Voltage.

Typical Performance (Continued)

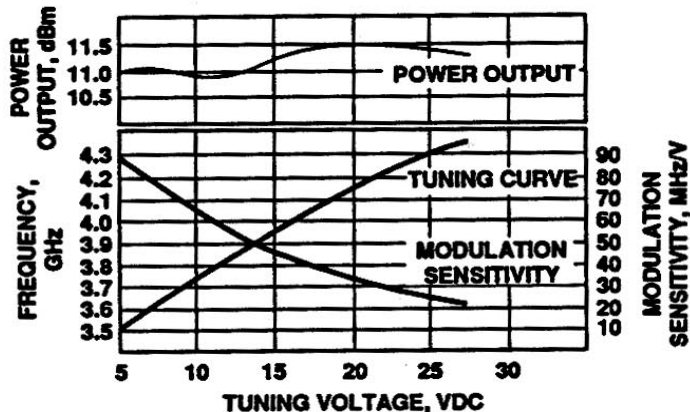

Figure 7. VTO-8360 Power Output, Frequency and Modulation Sensitivity vs. Tuning Voltage.

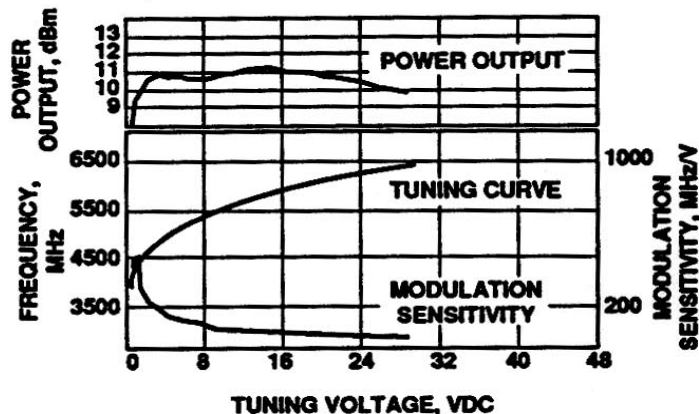

Figure 8. VTO-8430 Power Output, Frequency and Modulation Sensitivity vs. Tuning Voltage.

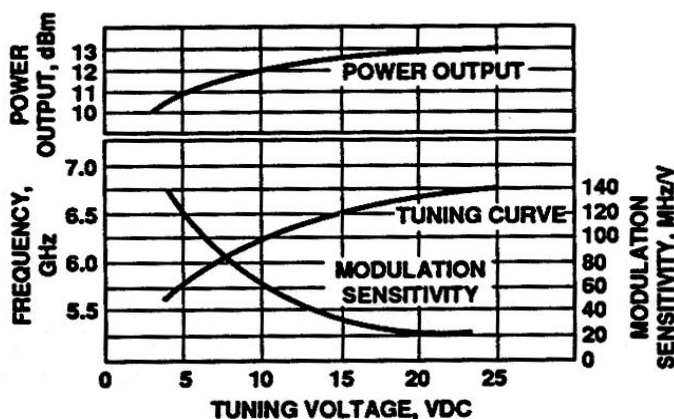

Figure 9. VTO-8580 Power Output, Frequency and Modulation Sensitivity vs. Tuning Voltage.

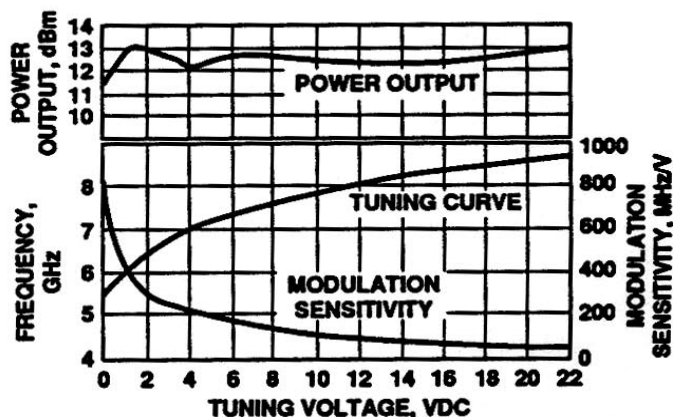

Figure 10. VTO-8650 Power Output, Frequency and Modulation Sensitivity vs. Tuning Voltage.

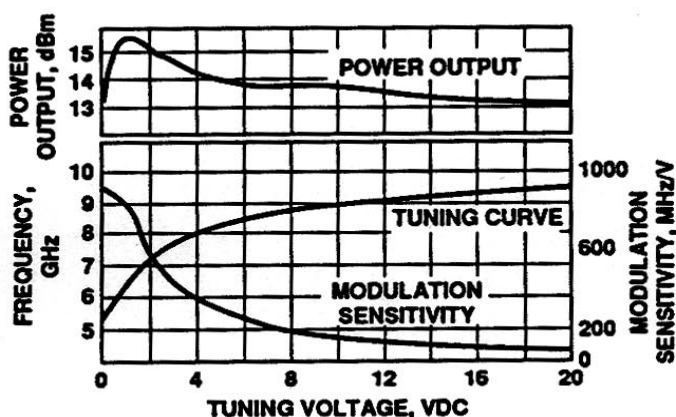

Figure 11. VTO-8810 Power Output, Frequency and Modulation Sensitivity vs. Tuning Voltage.

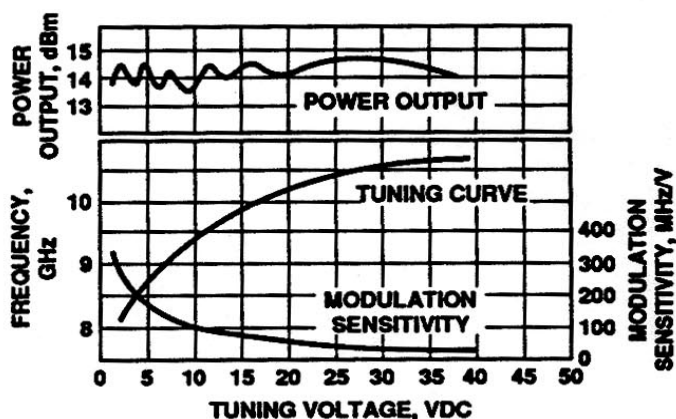

Figure 12. VTO-8850 Power Output, Frequency and Modulation Sensitivity vs. Tuning Voltage.

Typical Performance (Continued)

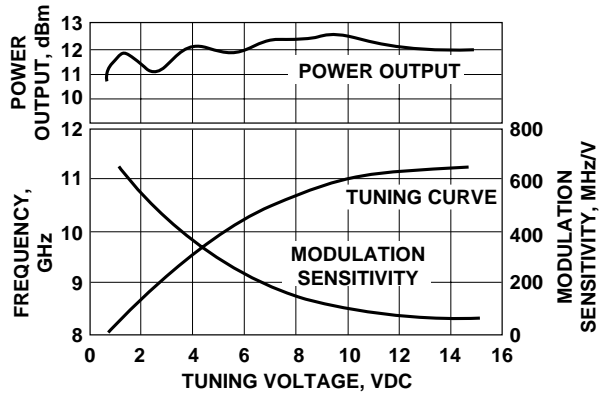

Figure 13. VTO-8950 Power Output, Frequency and Modulation Sensitivity vs. Tuning Voltage.

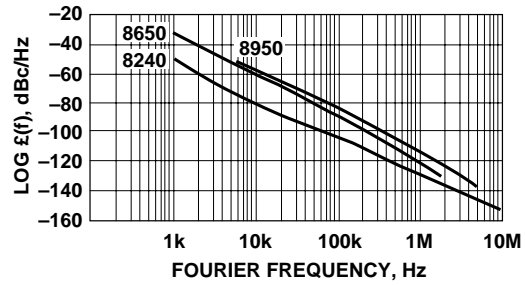
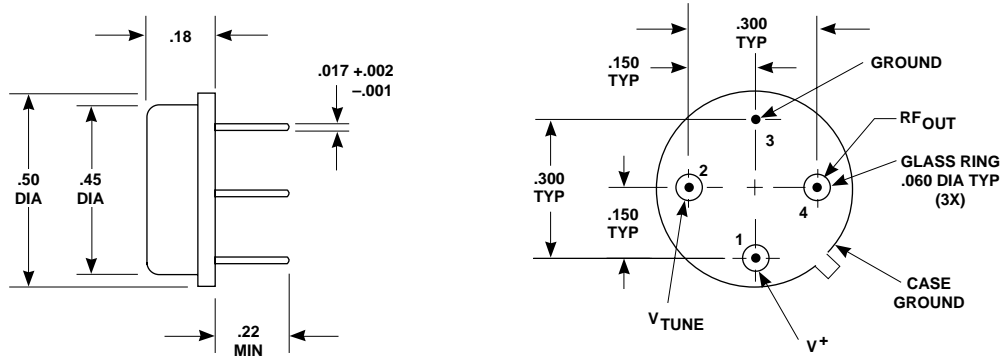

Figure 14. Noise Comparison Single Sideband Phase Noise.

TO-8V Case Drawing



APPROXIMATE WEIGHT 1.7 GRAMS

NOTES (UNLESS OTHERWISE SPECIFIED):
 1. DIMENSIONS ARE SPECIFIED IN INCHES
 2. TOLERANCES: xx ± .02
 xxx ± .010

Test Fixtures for TO-8 Packages (TF 801/802) Oscillators (VTO)

Features

- DC to 11 GHz Frequency Range
- Connectorized Tuning Port and RF Output
- Easy to Test Package
- Repeatable Performance

Applications

- Engineering Characterization
- Incoming Inspection
- System Prototype
- Demonstration of Device Performance

Description

To facilitate testing and prototyping of products in the TO-8V package, a series of test fixtures is available. Designated the HP TF Series test fixtures, they feature rugged construction for precise, repeatable measurements.

The TF Series test fixtures come supplied with mounting hardware to ensure excellent ground contact between the oscillator package and test fixture. This assures excellent contact between package pins and test fixture connector pins for reliable testing.

The device under test is aligned according to Figure 15, and pushed fully down onto the fixture. The steel mounting ring

clamp is placed over the device under test and secured by machine screws prior to testing. Orientation of pins can be verified by comparison with part (c) of Figure 15. It is recommended that both machine screws be used to fasten the ring clamp. Screws should be tightened down snugly with a jewelers type screwdriver.

For different connector options check the table in Figure 15 to identify the correct part numbers.

It should be noted that some output power variation may be seen, from unit data, at frequencies above 8 GHz. This is due to small differences in lengths of test fixture RF output connector pins.

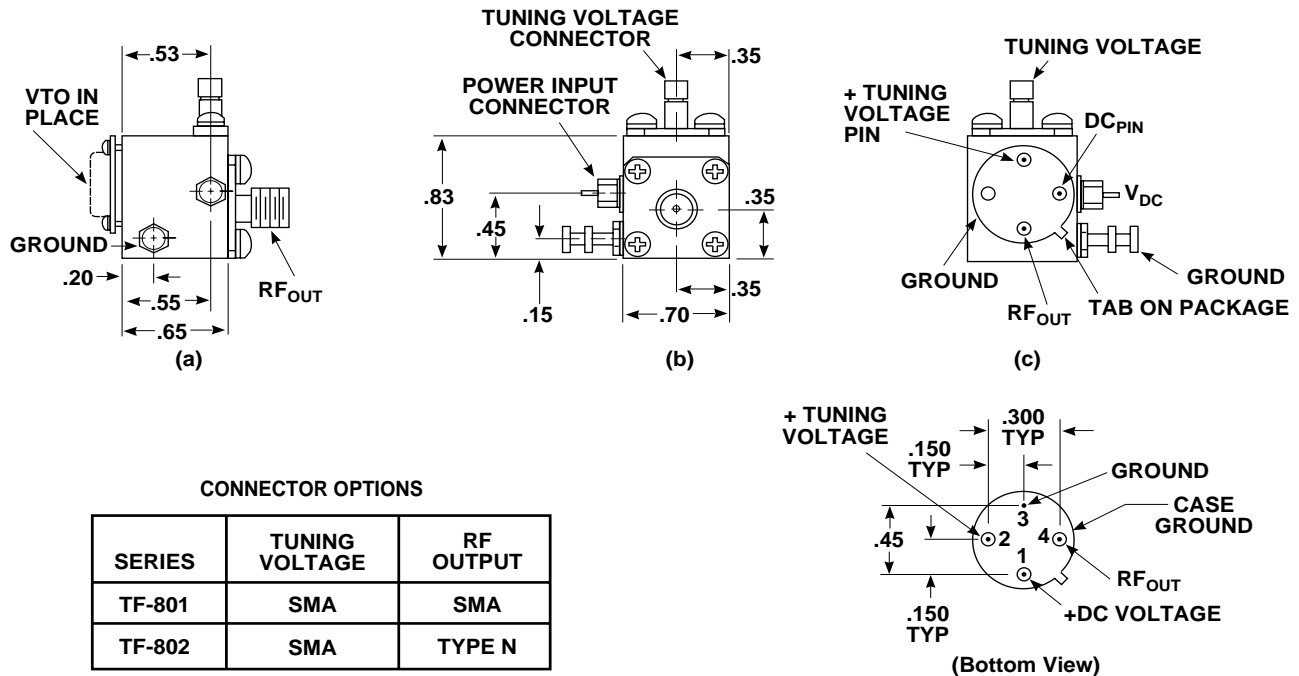

Figure 15. TO-8 Test Fixture.