

Continuous-Time Ratiometric Linear Hall Effect Sensor ICs

Not for New Design

These parts are in production but have been determined to be NOT FOR NEW DESIGN. This classification indicates that sale of this device is currently restricted to existing customer applications. The device should not be purchased for new design applications because obsolescence in the near future is probable. Samples are no longer available.

Date of status change: December 1, 2015

Recommended Substitutions:

For existing customer transition, and for new customers or new applications, contact the factory.

NOTE: For detailed information on purchasing options, contact your local Allegro field applications engineer or sales representative.

Allegro MicroSystems, LLC reserves the right to make, from time to time, revisions to the anticipated product life cycle plan for a product to accommodate changes in production capabilities, alternative product availabilities, or market demand. The information included herein is believed to be accurate and reliable. However, Allegro MicroSystems, LLC. assumes no responsibility for its use; nor for any infringements of patents or other rights of third parties which may result from its use.

Continuous-Time Ratiometric Linear Hall Effect Sensor ICs

FEATURES AND BENEFITS

- Low-noise output
- Fast power-on time
- Ratiometric rail-to-rail output
- 4.5 to 6.0 V operation
- Solid-state reliability
- Factory-programmed at end-of-line for optimum performance
- Robust ESD performance

Packages:

3-Pin SOT23W (suffix LH)

3-Pin SIP (suffix UA)

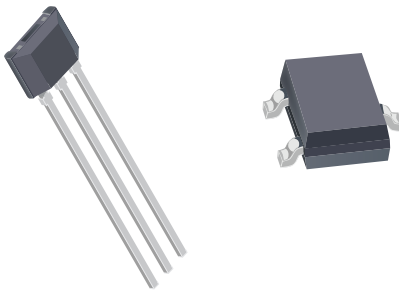

Not to scale

DESCRIPTION

The A1301 and A1302 are continuous-time, ratiometric, linear Hall-effect sensor ICs. They are optimized to accurately provide a voltage output that is proportional to an applied magnetic field. These devices have a quiescent output voltage that is 50% of the supply voltage. Two output sensitivity options are provided: 2.5 mV/G typical for the A1301, and 1.3 mV/G typical for the A1302.

The Hall-effect integrated circuit included in each device includes a Hall circuit, a linear amplifier, and a CMOS Class A output structure. Integrating the Hall circuit and the amplifier on a single chip minimizes many of the problems normally associated with low voltage level analog signals.

High precision in output levels is obtained by internal gain and offset trim adjustments made at end-of-line during the manufacturing process.

These features make the A1301 and A1302 ideal for use in position sensing systems, for both linear target motion and rotational target motion. They are well-suited for industrial applications over extended temperature ranges, from -40°C to 125°C .

Two device package types are available: LH, a 3-pin SOT23W type for surface mount, and UA, a 3-pin ultramini SIP for through-hole mount. They are lead (Pb) free (suffix, $-T$) with 100% matte tin plated leadframes.

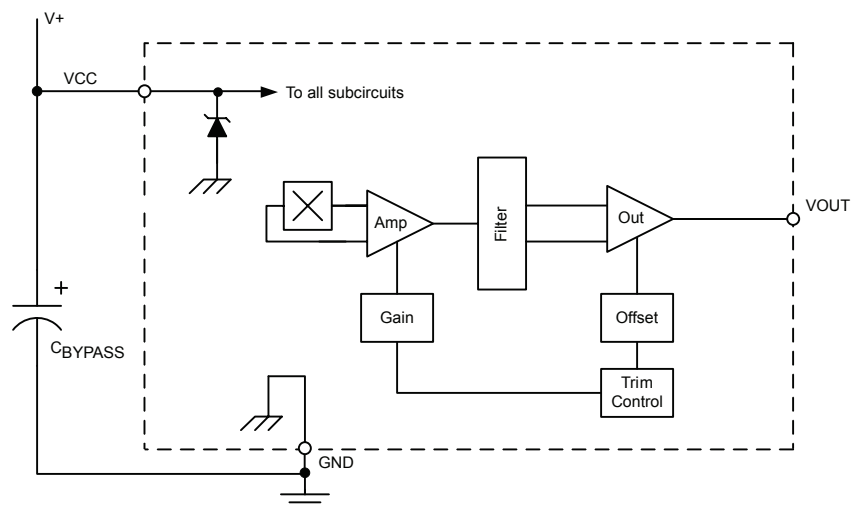

Functional Block Diagram

SPECIFICATIONS

Selection Guide				
Part Number	Packing*	Package	Ambient, T_A	Sensitivity (Typical)
A1301EUA-T	Bulk, 500 pieces/bag	SIP	-40°C to 85°C	2.5 mV/G
A1301KLHLT-T	7-in. reel, 3000 pieces/reel	Surface Mount	-40°C to 125°C	
A1301KLHLX-T	13-in. reel, 10000 pieces/reel	Surface Mount		
A1301KUA-T	Bulk, 500 pieces/bag	SIP	-40°C to 85°C	1.3 mV/G
A1302ELHLT-T	7-in. reel, 3000 pieces/reel	Surface Mount	-40°C to 125°C	
A1302ELHLX-T	13-in. reel, 10000 pieces/reel	Surface Mount		
A1302KLHLT-T	7-in. reel, 3000 pieces/reel	Surface Mount	-40°C to 125°C	
A1302KLHLX-T	13-in. reel, 10000 pieces/reel	Surface Mount		
A1302KUA-T	Bulk, 500 pieces/bag	SIP		



*Contact Allegro™ for additional packing options.

Absolute Maximum Ratings

Characteristic	Symbol	Notes	Rating	Units
Supply Voltage	V_{CC}		8	V
Output Voltage	V_{OUT}		8	V
Reverse Supply Voltage	V_{RCC}		-0.1	V
Reverse Output Voltage	V_{ROUT}		-0.1	V
Output Sink Current	I_{OUT}		10	mA
Operating Ambient Temperature	T_A	Range E	-40 to 85	°C
		Range K	-40 to 125	°C
Maximum Junction Temperature	$T_J(\text{max})$		165	°C
Storage Temperature	T_{stg}		-65 to 170	°C

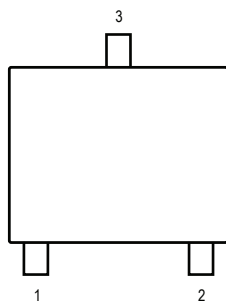

Package LH SOT23W Pin-out Diagram

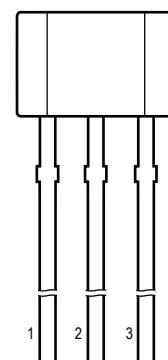

Package UA, 3-Pin SIP Pin-out Diagram

Terminal List

Symbol	Number		Description
	Package LH	Package UA	
VCC	1	1	Connects power supply to chip
VOUT	2	3	Output from circuit
GND	3	2	Ground

DEVICE CHARACTERISTICS over operating temperature range, T_A , and $V_{CC} = 5\text{ V}$, unless otherwise noted

Characteristic	Symbol	Test Conditions	Min.	Typ.	Max.	Units
Electrical Characteristics						
Supply Voltage	V_{CC}	Running, $T_J < 165^\circ\text{C}$	4.5	–	6	V
Supply Current	I_{CC}	Output open	–	–	11	mA
Output Voltage	$V_{OUT(High)}$	$I_{SOURCE} = -1\text{ mA}$, Sens = nominal	4.65	4.7	–	V
	$V_{OUT(Low)}$	$I_{SINK} = 1\text{ mA}$, Sens = nominal	–	0.2	0.25	V
Output Bandwidth	BW		–	20	–	kHz
Power-On Time	t_{PO}	$V_{CC(min)}$ to $0.95 V_{OUT}$; $B = \pm 1400\text{ G}$; Slew rate = $4.5\text{ V}/\mu\text{s}$ to $4.5\text{ V}/100\text{ ns}$	–	3	5	μs
Output Resistance	R_{OUT}	$I_{SINK} \leq 1\text{ mA}$, $I_{SOURCE} \geq -1\text{ mA}$	–	2	5	Ω
Wide Band Output Noise, rms	V_{OUTN}	External output low pass filter $\leq 10\text{ kHz}$; Sens = nominal	–	150	–	μV
Ratiometry						
Quiescent Output Voltage Error with respect to ΔV_{CC} ¹	$\Delta V_{OUTQ(V)}$	$T_A = 25^\circ\text{C}$	–	–	± 3.0	%
Magnetic Sensitivity Error with respect to ΔV_{CC} ²	$\Delta \text{Sens}_{(V)}$	$T_A = 25^\circ\text{C}$	–	–	± 3.0	%
Output						
Linearity	Lin	$T_A = 25^\circ\text{C}$	–	–	± 2.5	%
Symmetry	Sym	$T_A = 25^\circ\text{C}$	–	–	± 3.0	%
Magnetic Characteristics						
Quiescent Output Voltage	V_{OUTQ}	$B = 0\text{ G}$; $T_A = 25^\circ\text{C}$	2.4	2.5	2.6	V
Quiescent Output Voltage over Operating Temperature Range	$V_{OUTQ(\Delta T_A)}$	$B = 0\text{ G}$	2.2	–	2.8	V
Magnetic Sensitivity	Sens	A1301; $T_A = 25^\circ\text{C}$	2.0	2.5	3.0	mV/G
		A1302; $T_A = 25^\circ\text{C}$	1.0	1.3	1.6	mV/G
Magnetic Sensitivity over Operating Temperature Range	$\text{Sens}_{(\Delta T_A)}$	A1301	1.8	–	3.2	mV/G
		A1302	0.85	–	1.75	mV/G

¹Refer to equation (4) in Ratiometric section on page 4.

²Refer to equation (5) in Ratiometric section on page 4.

CHARACTERISTIC DEFINITIONS

Quiescent Output Voltage

In the quiescent state (no significant magnetic field: $B = 0$), the output, V_{OUTQ} , equals one half of the supply voltage, V_{CC} , throughout the entire operating ranges of V_{CC} and ambient temperature, T_A . Due to internal component tolerances and thermal considerations, there is a tolerance on the quiescent output voltage, ΔV_{OUTQ} , which is a function of both ΔV_{CC} and ΔT_A . For purposes of specification, the quiescent output voltage as a function of temperature, $\Delta V_{OUTQ(\Delta T_A)}$, is defined as:

$$\Delta V_{OUTQ(\Delta T_A)} = \frac{V_{OUTQ(T_A)} - V_{OUTQ(25^\circ C)}}{Sens_{(25^\circ C)}} \quad (1)$$

where $Sens$ is in mV/G, and the result is the device equivalent accuracy, in gauss (G), applicable over the entire operating temperature range.

Sensitivity

The presence of a south-polarity (+B) magnetic field, perpendicular to the branded face of the device package, increases the output voltage, V_{OUT} , in proportion to the magnetic field applied, from V_{OUTQ} toward the V_{CC} rail. Conversely, the application of a north polarity (-B) magnetic field, in the same orientation, proportionally decreases the output voltage from its quiescent value. This proportionality is specified as the magnetic sensitivity of the device and is defined as:

$$Sens = \frac{V_{OUT(-B)} - V_{OUT(+B)}}{2B} \quad (2)$$

The stability of the device magnetic sensitivity as a function of ambient temperature, $\Delta Sens_{(\Delta T_A)}$ (%) is defined as:

$$\Delta Sens_{(\Delta T_A)} = \frac{Sens_{(T_A)} - Sens_{(25^\circ C)}}{Sens_{(25^\circ C)}} \times 100\% \quad (3)$$

Ratiometric

The A1301 and A1302 feature a ratiometric output. This means that the quiescent voltage output, V_{OUTQ} , and the magnetic sensitivity, $Sens$, are proportional to the supply voltage, V_{CC} .

The ratiometric change (%) in the quiescent voltage output is defined as:

$$\Delta V_{OUTQ(\Delta V)} = \frac{V_{OUTQ(V_{CC})} / V_{OUTQ(5V)}}{V_{CC} / 5V} \times 100\% \quad (4)$$

and the ratiometric change (%) in sensitivity is defined as:

$$\Delta Sens_{(\Delta V)} = \frac{Sens_{(V_{CC})} / Sens_{(5V)}}{V_{CC} / 5V} \times 100\% \quad (5)$$

Linearity and Symmetry

The on-chip output stage is designed to provide linear output at a supply voltage of 5 V. Although the application of very high magnetic fields does not damage these devices, it does force their output into a nonlinear region. Linearity in percent is measured and defined as:

$$Lin^+ = \frac{V_{OUT(+B)} - V_{OUTQ}}{2(V_{OUT(+B/2)} - V_{OUTQ})} \times 100\% \quad (6)$$

$$Lin^- = \frac{V_{OUT(-B)} - V_{OUTQ}}{2(V_{OUT(-B/2)} - V_{OUTQ})} \times 100\% \quad (7)$$

and output symmetry as:

$$Sym = \frac{V_{OUT(+B)} - V_{OUTQ}}{V_{OUTQ} - V_{OUT(-B)}} \times 100\% \quad (8)$$

TYPICAL CHARACTERISTICS
(30 pieces, 3 fabrication lots)

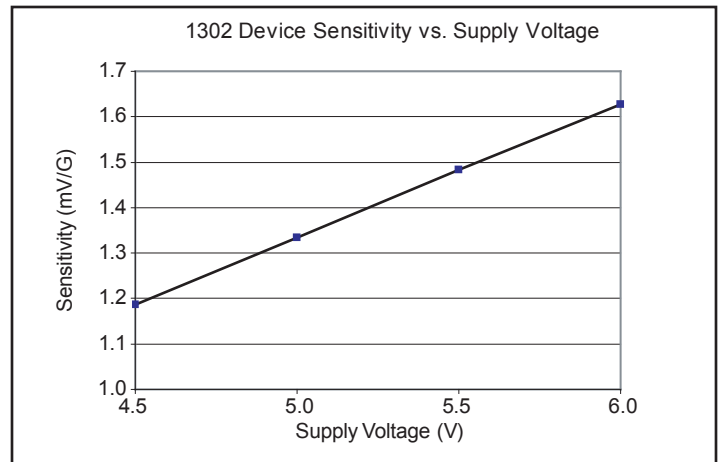
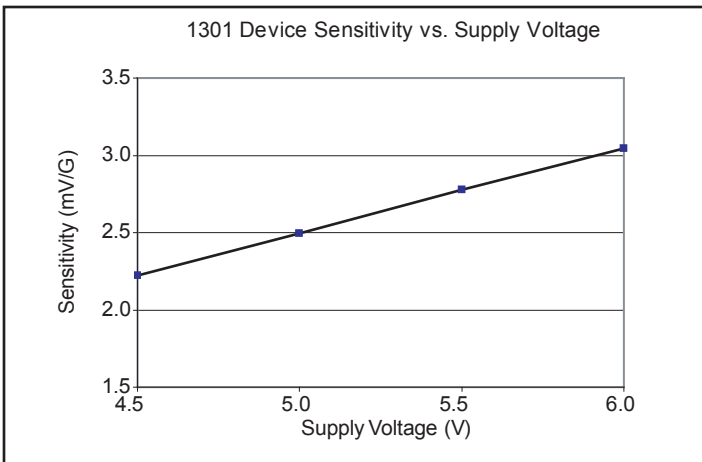
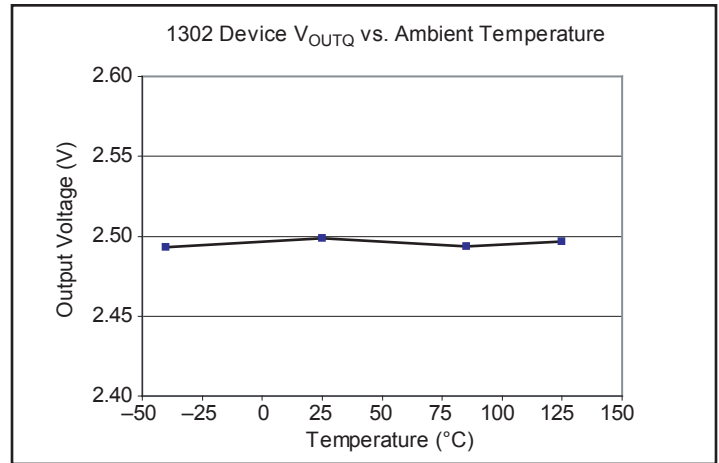
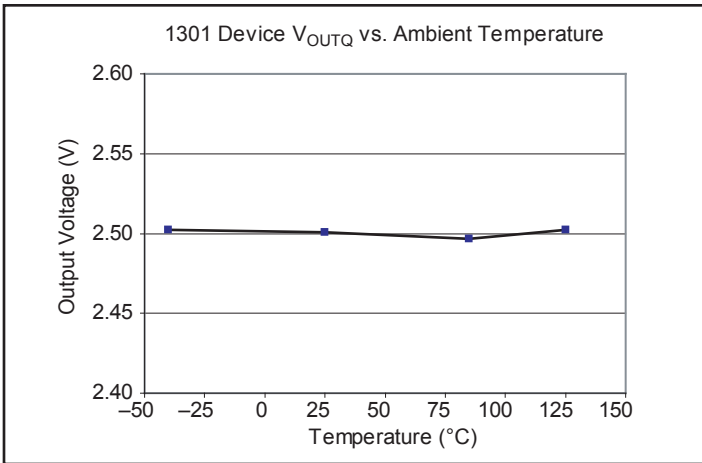
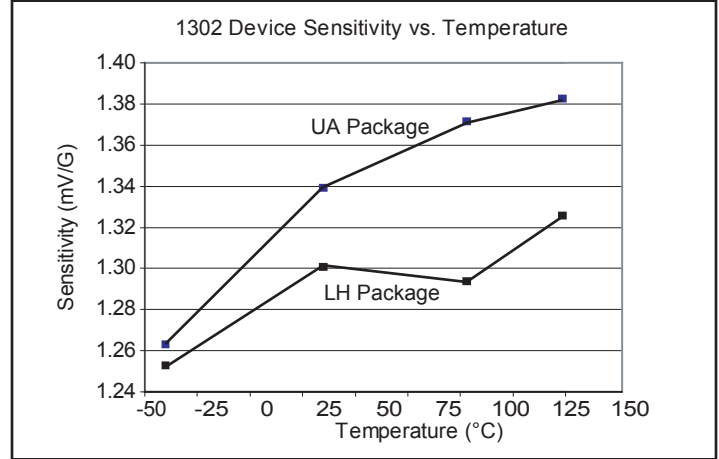
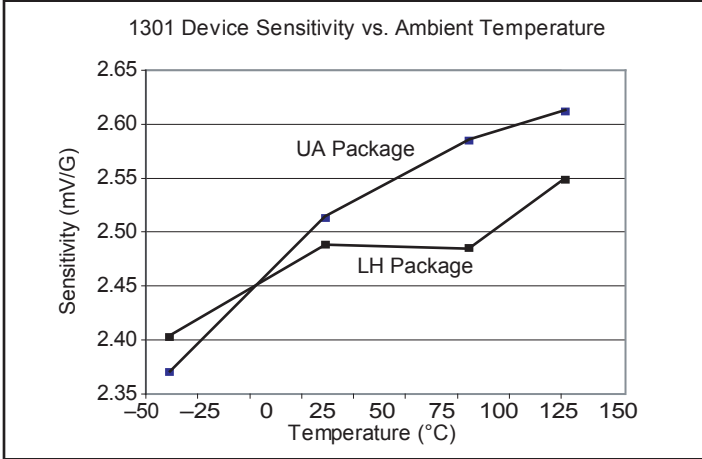

Continued on the next page...

TYPICAL CHARACTERISTICS CONTINUED
(30 pieces, 3 fabrication lots)

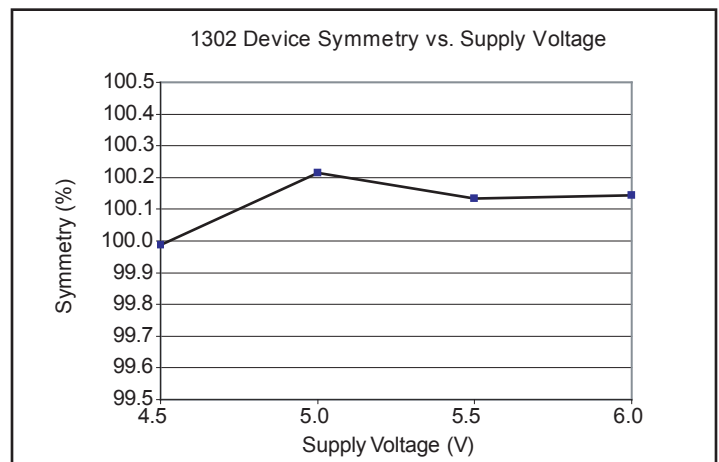
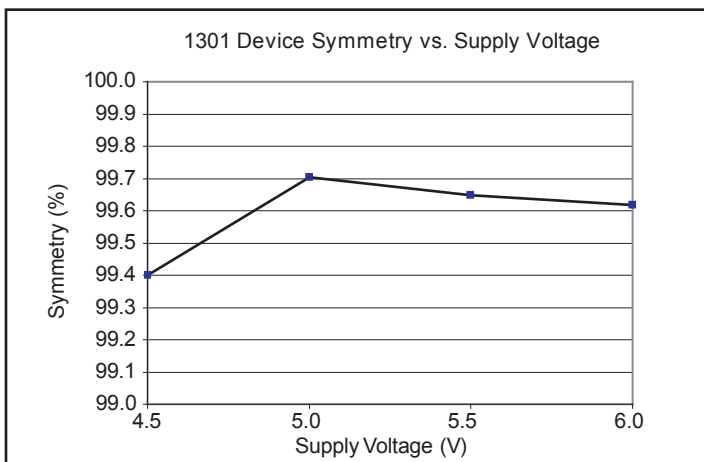
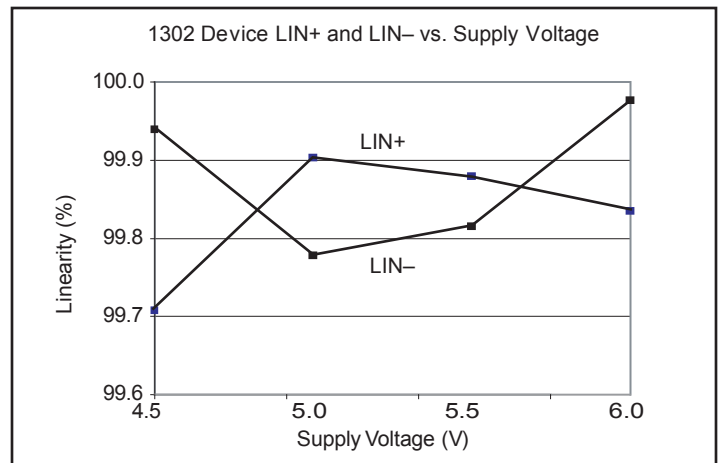
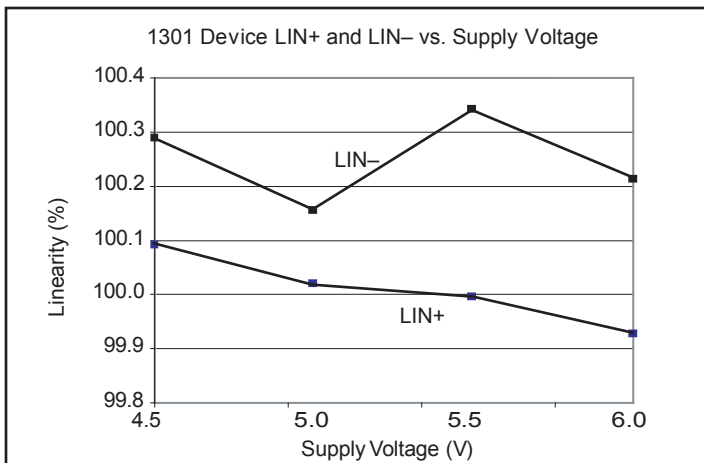
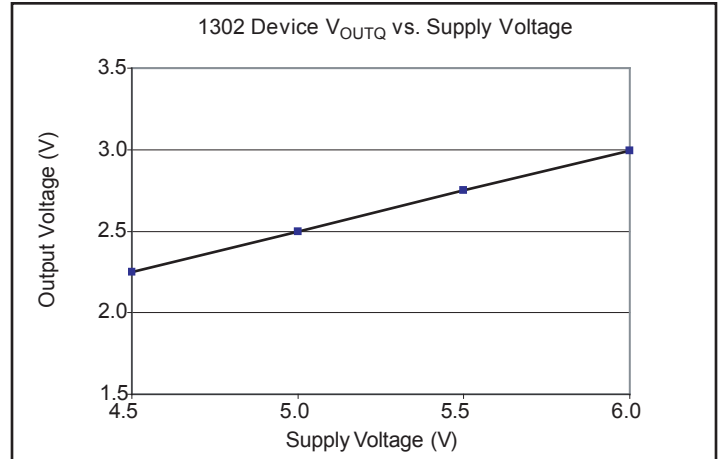
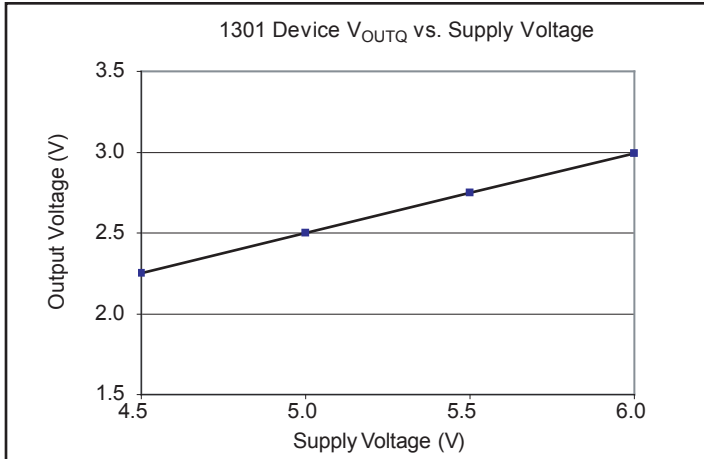

CUSTOMER OUTLINE DRAWINGS

For Reference Only – Not for Tooling Use

(Reference DWG-2840)

Dimensions in millimeters – NOT TO SCALE

Dimensions exclusive of mold flash, gate burrs, and dambar protrusions
Exact case and lead configuration at supplier discretion within limits shown

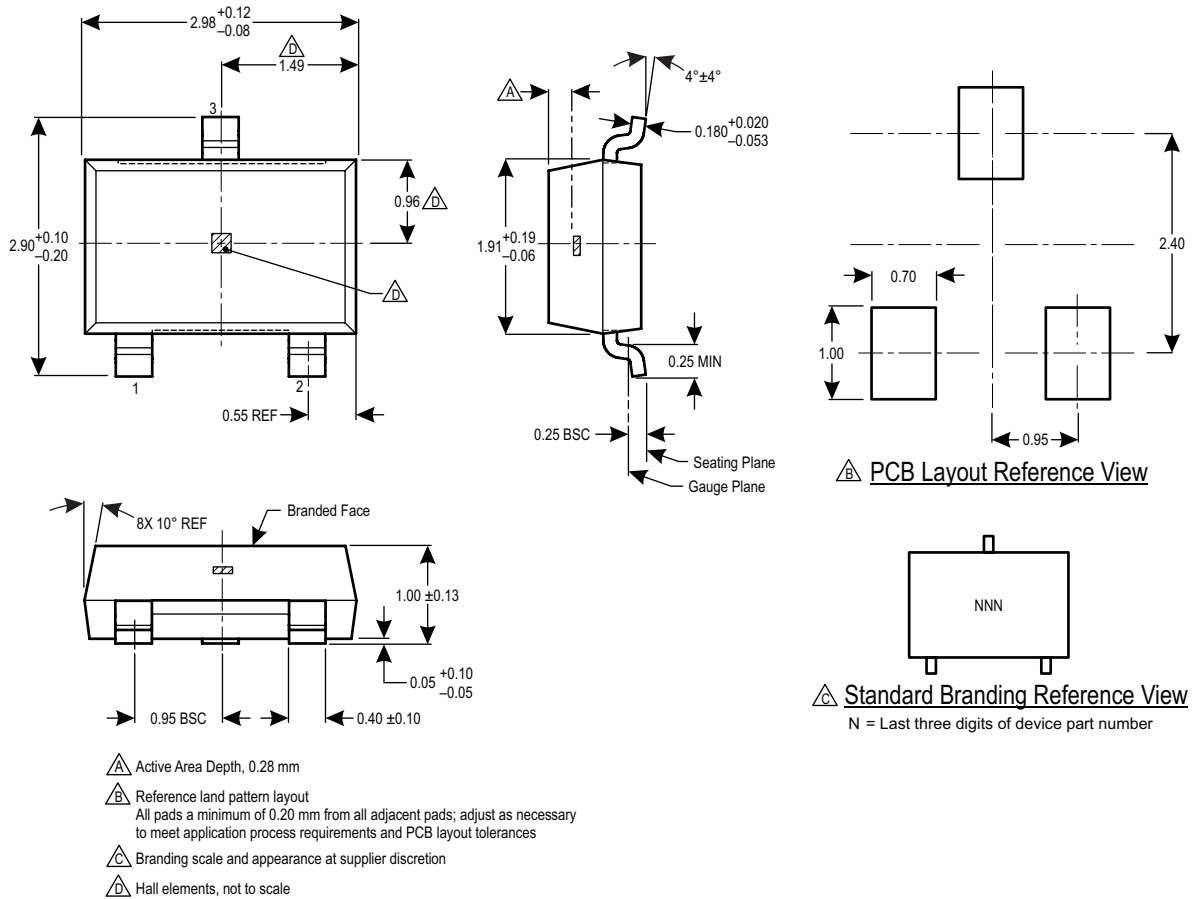

Figure 1: Package LH, 3-Pin; (SOT-23W)

For Reference Only – Not for Tooling Use

(Reference DWG-9065)

Dimensions in millimeters – NOT TO SCALE

Dimensions exclusive of mold flash, gate burrs, and dambar protrusions

Exact case and lead configuration at supplier discretion within limits shown

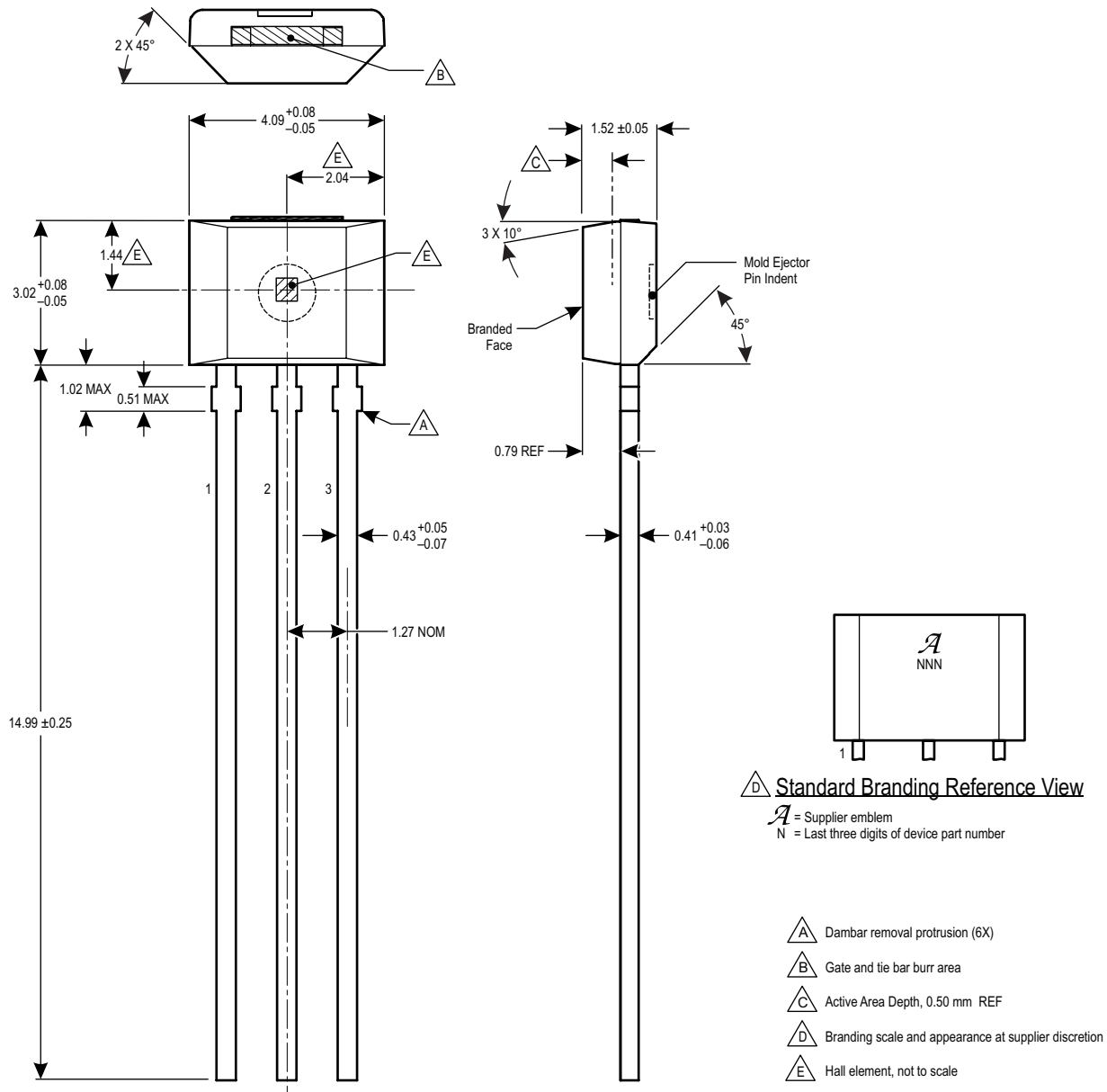

Figure 2: Package UA, 3-Pin SIP

Revision History

Revision	Revision Date	Description of Revision
18	April 26, 2013	Update UA package drawing
19	January 1, 2015	Add LX option to Selection Guide
20	July 13, 2015	Corrected LH package Active Area Depth value
21	December 1, 2015	Updated product status to "Not for New Design"

Copyright ©2005-2015, Allegro MicroSystems, LLC

Allegro MicroSystems, LLC reserves the right to make, from time to time, such departures from the detail specifications as may be required to permit improvements in the performance, reliability, or manufacturability of its products. Before placing an order, the user is cautioned to verify that the information being relied upon is current.

Allegro's products are not to be used in life support devices or systems, if a failure of an Allegro product can reasonably be expected to cause the failure of that life support device or system, or to affect the safety or effectiveness of that device or system.

The information included herein is believed to be accurate and reliable. However, Allegro MicroSystems, LLC assumes no responsibility for its use; nor for any infringement of patents or other rights of third parties which may result from its use.

For the latest version of this document, visit our website:

www.allegromicro.com

