

5112 N

## DC axial compact fan



### ebm-papst St. Georgen GmbH & Co. KG

Hermann-Papst-Straße 1

D-78112 St. Georgen

Phone +49 7724 81-0

Fax +49 7724 81-1309

info2@de.ebmpapst.com

www.ebmpapst.com

### Nominal data

Type	5112 N	
Nominal voltage	VDC	12
Nominal voltage range	VDC	6 .. 15
Speed	min <sup>-1</sup>	2900
Power input	W	9.5
Min. ambient temperature	°C	-25
Max. ambient temperature	°C	72
Air flow	m <sup>3</sup> /h	250
Sound power level	B	6.1
Sound pressure level	dB(A)	48

ml = max. load · me = max. efficiency · rfa = running at free air · cs = customer specs · cu = customer unit  
Subject to alterations



### Technical features

<b>Dimensions</b>	135 x 135 x 38 mm
<b>General description</b>	<p>General features:  Housing and impeller made of aluminium; housing with grounding lug for M4 x 8 screw (Torx). 48 V version incl. screws.  Electronic commutation completely integrated.  Protected against reverse polarity and locking.  Connection via single strands AWG 22, TR 64, bared and tin-plated.  Air exhaust over bars. Direction of rotation counter-clockwise seen on rotor.  Mass: 650 g.</p>
<b>Connection line</b>	Single strands AWG 22, TR 64, bared and tin-plated.
<b>Locked-rotor protection</b>	Electronic blocking protection
<b>Direction of rotation</b>	Left, looking at rotor
<b>Direction of air flow</b>	Air exhaust over bars
<b>Bearing</b>	Ball bearings
<b>Lifetime L10 at 40 °C</b>	80000 h
<b>Lifetime L10 at maximum temperature</b>	37500 h
<b>Mass</b>	0.650 kg
<b>Housing material</b>	Aluminum. Housing with grounding lug for screw M4 x 8 (TORX).
<b>Material of impeller</b>	Aluminum
<b>Motor protection</b>	Protected against reverse polarity and locking.
<b>Approval</b>	CE

## Product drawing

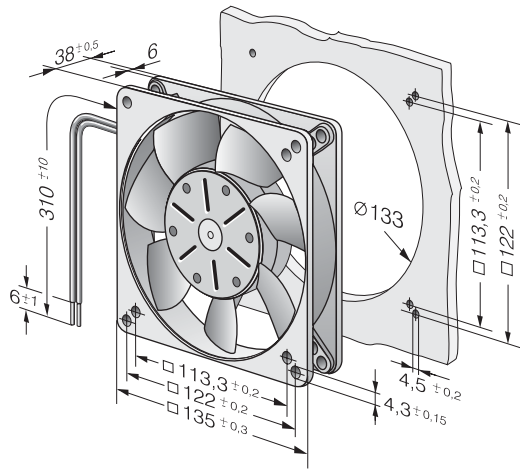

## Charts: Air flow

