

RoHS

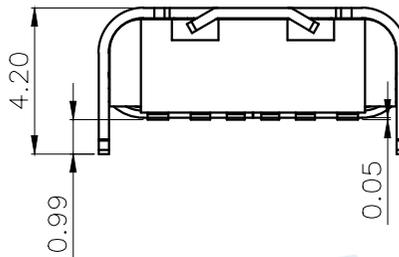

PIN ASSIGNMENTS

A5	CC1	B12	GND
A9	VBUS	B9	VBUS
A12	GND	B5	CC2
PIN	SIGNAL NAME	PIN	SIGNAL NAME

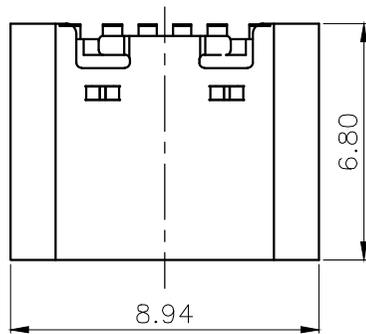
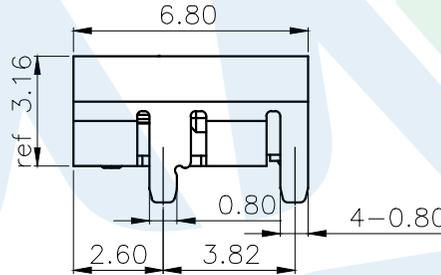
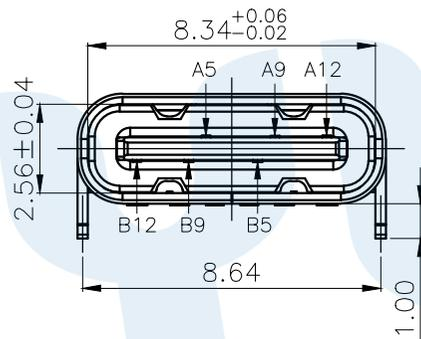
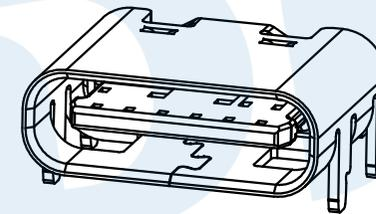

- SPECIFICATION,
 - 1-1.INSERTION FORCE: 0.5~2.0kgf.
 - 1-2.REMOVAL FORCE: 0.8kgf~2.0kgf.
 - 1-3.DURABILITY: 10000 CYCLES.
- ELECTRICAL PERFORMANCE,
 - 2-1. CURRENT RATING:3.0A
VOLTAGE RATING:5.0V
 - 2-2. LLCR:
VBUS & GND PINS AND OTHER PINS: 40mΩ/PIN MAX.
SHIELD: 50mΩ/MAX.
LLCR MAX. CHANGE OF ALL PINS: 10mΩ.
 - 4-3.INSULATION RESISTANCE: 100MΩ MIN
 - 4-4.DIELECTRIC WITHSTAND VOLTAGE,AC 100V FOR 1 MINUTE.
- ENVIRONMENTAL PERFORMANCE:
OPERATING TEMPERATURE: -25°C~+85°C.
- IR REFLOW:
THE PEAK TEMPERATURE ON THE BOARD SHALL BE MAINTAINED FOR 10 SECONDS AT 260°C.

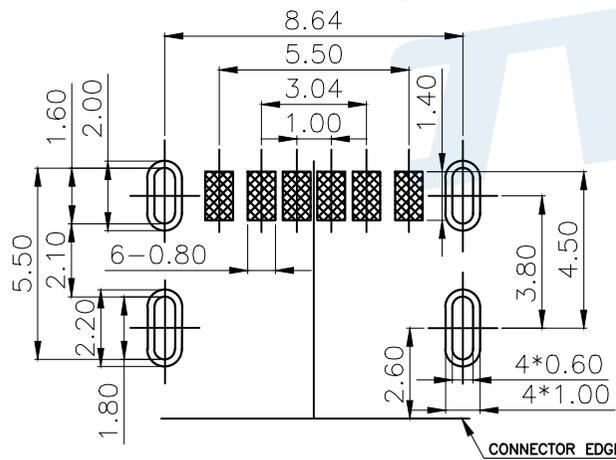
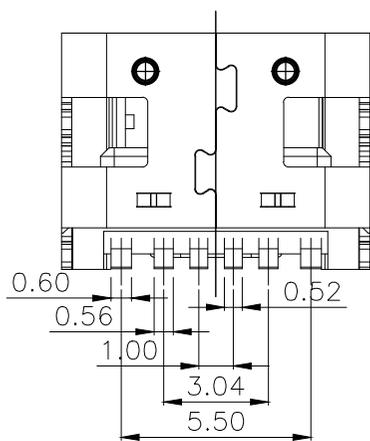

Recommended P.C.B Layout

◎	Terminal		6	Phosphor bronze	Au Plating
ⓑ	Shee		1	Stainless Steel	Ni Plating
Ⓐ	Base		1	LCP	White
NO.	Name	Number	Qty	Materil	Remarks

YUANDI® Yuandi Electronics Co, Ltd
元典

design	date	name	USB CONNECTOR
Review	date	model	TYPE-603-T3-W
Approved	date		

Drawing number: Proportion 1:1 unit mm gage number A4

modify Review Approved Tolerance not specified

angle	±2'
10~30	±0.30
5~10	±0.20
~ 5	±0.10