



FD5T Series

FD51xxT-32.768KHz

CMOS Clock Oscillator

March 2009

- Pletronics' FD51T Series is a quartz crystal controlled precision square wave generator
- Output frequency 32.768KHz
- Selectable low jitter or spread spectrum output.
- Device characteristics may be either factory or field programmable
- Tape and Reel or cut tape packaging is available
- 3.2 x 5 mm LCC Ceramic Package
- Stability is much better than an XY cut watch crystal
- Very fast Start-up time, <10mS
- Low power
- 1.8V, 2.5 or 3.3V LVCMOS outputs
- Designed for high density SMD needs

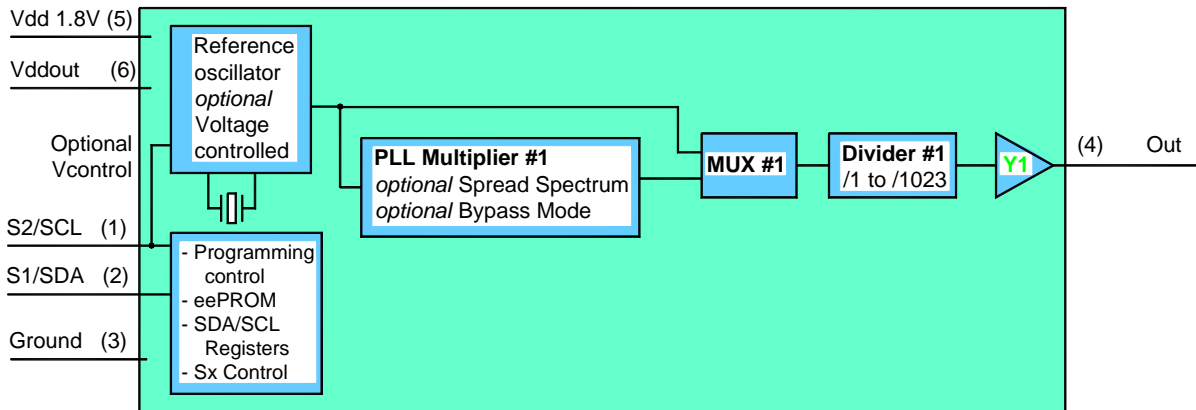

Pletronics Inc. certifies this device is in accordance with the RoHS 6/6 (2002/95/EC) and WEEE (2002/96/EC) directives.

Pletronics Inc. guarantees the device does not contain the following:
 Cadmium, Hexavalent Chromium, Lead, Mercury, PBB's, PBDE's
 Weight of the Device: 0.09 grams
 Moisture Sensitivity Level: 1 As defined in J-STD-020C
 Second Level Interconnect code: e4

Absolute Maximum Ratings:

Parameter	Unit
V_{DD}	-0.5V to +2.5V
V_{DDOUT}	-0.5V to +4.6V
V_i Input Voltage	-0.5V to $V_{DD} + 0.5V$
V_o Output Voltage	-0.5V to $V_{DDOUT} + 0.5V$
I_o Continuous Output Current	± 50 mA
T_j Maximum Junction Temperature	125°C
Thermal Resistance, Junction to Case	50°C/Watt

Description:

The FD51xxT-32.768K is derived from the PLE FD51T series Programmable CMOS Clock Oscillator which is a modular PLL-based low cost, high-performance oscillator. The frequency output is set to 32.768KHz. The FD51xxT-32.768K base frequency is a 24.576MHz AT cut fundamental mode crystal.

The FD51T has a separate output supply pin, V_{DDOUT} , for either 1.8, 2.5 or 3.3V output logic levels. The device supply, V_{DD} which provides power to all the internal circuits, is nominally 1.8V.

The PLL is only utilized to support Spread Spectrum Clocking (SSC), in all other cases the PLL is disabled to reduce power. SSC may be programmed to be either center-spread or down-spread. This is an important technique to reduce electro-magnetic interference (EMI).

The device supports non-volatile eePROM programming for easy customization of the device. As shipped, the device is pre-programmed. However, the FD51xxT-32.768K may be reprogrammed to a different configuration. Reprogramming may be either prior to assembly, or in-circuit via a 2-wire SDA/SCL I²C bus. In-circuit programming is not allowed if the VCXO function is needed.

Two programmable control inputs, S1 and S2, may be used to control various aspects of FD51xxT-32.768K operation including selection of alternative frequency set(s), selection of SSC functionality, output tri-state and power-down.

Reference Oscillator

The VCXO input has a limited voltage range, the VCXO is associated with the internal 1.8V core. A resistor in series with the Vcontrol input will permit interfacing to 3.3V analog circuits, the voltage range that changes the frequency will still be limited but the larger voltages swings will not cause problems.

The VCXO function is only enabled (internally connected) if the part number indicates a VCXO specification. When the VCXO function is enabled the I²C programming mode will be disabled.

PLL Multiplier

The PLL Multiplier is enabled when tight tolerances are needed or when the spread spectrum function is needed.

Spread Spectrum

The PLL has its individual Spread Spectrum (SS) function that can be enabled. This permits the modulation of the output frequency by a user-set amount.

Divider Section

The dividers operate on the output of the PLL. The divider on the PLL can divide by 1 through 1023 and is set to 750 in this case. There is only 1 setting allowed per divider. These are not set by the Sx input state.

The dividers add very little jitter to the output signals.

Multiplexers

MUX #1 selects the input to the Divider #1, this can be the reference oscillator signal or the output from

PLL Multiplier #1.

The device can make only one of the setting of connections shown in the block diagram (only one pattern stored in eePROM).

Control Inputs

The two inputs, S1/SDA and S2/SCL can be configured in two ways.

- 1) Used as 2 user inputs to permit up to 4 states, Sx input setting.
- 2) The SDA and SCL become clock and data inputs to write to the FD5T internal setting memory. The interface follows the I²C protocol. If the SDA and SCL are not set then the internal eePROM sets the operation. (Not allowed if the VCXO function is specified.)

Standard Configuration

S1	S2	Output	SS	PLL
Low	Low	Tri State	---	Disable
High	Low	32.768KHz	±1% centered	Enable
Low	High	32.768KHz	±2% centered	Enable
High	High	32.768KHz	none	Disable

PART NUMBER:

FD5 1 45 T L E -32.768K -YYY

	Packaging code or blank T250 = 250 per Tape and Reel T500 = 500 per Tape and Reel T1K = 1000 per Tape and Reel
	Output Frequency - 32.768KHz
	Optional Enhanced Operating temperature Range Blank = Temp. range -20°C to +70°C E = Temp. range -40°C to +85°C
	Blank = V _{DDOUT} 3.3V, 2.5V and 1.8V device L = V _{DDOUT} 1.8V only - high output drive level device
	Series Model
	Frequency Stability for fixed frequency oscillator 45 = ± 50 ppm 15 = ± 15 ppm ¹ 44 = ± 25 ppm 10 = ± 10 ppm ¹ 20 = ± 20 ppm
	Frequency Pull Ability for VCXO option enabled 99 = ± 100 ppm Absolute Pull Range (APR) 75 = ± 25 ppm Absolute Pull Range (APR) 50 = ± 50 ppm Absolute Pull Range (APR)
	1 = 1 output 1 PLL version
	Series Model

¹In these cases the PLL will be enabled and the power dissipation will be higher.

Part Marking:

PLE FD51 Marking Legend: PLE = Pletronics
32.768K YMD = Date of Manufacture (year-month-day)
YMD All other marking is internal factory codes

Codes for Date Code YMD

Code	8	9	0	1	2	Code	A	B	C	D	E	F	G	H	J	K	L	M
Year	2008	2009	2010	2011	2012	Month	JAN	FEB	MAR	APR	MAY	JUN	JUL	AUG	SEP	OCT	NOV	DEC

Code	1	2	3	4	5	6	7	8	9	A	B	C	D	E	F	G
Day	1	2	3	4	5	6	7	8	9	10	11	12	13	14	15	16
Code	H	J	K	L	M	N	P	R	T	U	V	W	X	Y	Z	
Day	17	18	19	20	21	22	23	24	25	26	27	28	29	30	31	

Electrical Specification over the specified temperature range.

Item	Min	Max	Unit	Condition	
Frequency Accuracy	"45"	-50	+50	ppm	For all supply voltages, load changes, aging for 1 year, shock, vibration and temperatures
	"44"	-25	+25		
	"20"	-20	+20		
	"15"	-15	+15		
	"10"	-10	+10		
Start-up Time	--	10	mS		
Recommended Operating Conditions					
Device Supply Voltage V_{DD}	1.7	1.9	V		
Output Supply Voltage V_{DDOUT}	1.7	3.6	V		
Output Supply Voltage "L" V_{DDOUT}	1.7	1.9	V		
Low Level Input voltage	--	30	%	of V_{DD}	
High Level Input voltage	70	--	%	of V_{DD}	
Input Voltage Range, S1, S2	0	3.6	V	V_{TH} is $0.5 * V_{DD}$	
Input current for: S1, S2	0	5	μ A	$V_{IN} = V_{DD}; V_{DD} = 1.9V$	
	-4	0	μ A	$V_{IN} = 0.0V_D; V_{DD} = 1.9V$	
Output Current, $V_{DDOUT} = 3.3V$	-12	+12	mA		
Output Current, $V_{DDOUT} = 2.5V$	-10	+10	mA		
Output Current, $V_{DDOUT} = 1.8V$	-5	+5	mA		
Output Current "L", $V_{DDOUT} = 1.8V$	-8	+8	mA		
Output Load, LVCMOS	--	10	pf	Higher loads can be used	
LVCMOS Output Parameters for $V_{DDOUT} = 3.3v$					
Output High, $V_{DDOUT} = 3.3V$	2.9	--	V	$I_{OH} = -0.1$ mA	
	2.4	--	V	$I_{OH} = -8.0$ mA	
	2.2	--	V	$I_{OH} = -12.0$ mA	
Output Low, $V_{DDOUT} = 3.3V$	--	0.1	V	$I_{OH} = +0.1$ mA	
	--	0.5	V	$I_{OH} = +8.0$ mA	
	--	0.8	V	$I_{OH} = +12.0$ mA	
Rise & Fall Time	--	0.6	nS	$V_{DDOUT} = 3.3v, 20 - 80\%, 10pF$ Load	
I_{DD} (no PLL enabled)	--	2.5	mA		
I_{DD} (PLL enabled)	--	9	mA	SS option or 15ppm or 10 ppm stability	
I_{DDOUT}	--	5	μ A	10pF Load	
Output Symmetry	45	55	%	at 50% point of V_{DDOUT}	
Peak-to-Peak Jitter ⁽¹⁾	--	10	pS	(No SS and PLL disabled)	

Item	Min	Max	Unit	Condition
LVC MOS Output Parameters for $V_{DDOUT} = 2.5V$				
Output High, $V_{DDOUT} = 2.5V$	2.2	--	V	$I_{OH} = -0.1$ mA
	1.7	--	V	$I_{OH} = -6.0$ mA
	1.6	--	V	$I_{OH} = -10.0$ mA
Output Low, $V_{DDOUT} = 2.5V$	--	0.1	V	$I_{OH} = +0.1$ mA
	--	0.5	V	$I_{OH} = +6.0$ mA
	--	0.7	V	$I_{OH} = +10.0$ mA
Rise & Fall Time	--	0.6	nS	$V_{DDOUT} = 2.5V$, 20 - 80%, 10pF Load
Output Symmetry	45	55	%	at 50% point of V_{DDOUT}
I_{DD} (no PLL enabled)	--	2.5	mA	
I_{DD} (PLL enabled)	--	9	mA	SS option or 15ppm or 10 ppm stability
I_{DDOUT}	--	4	uA	10pF Load
Peak-to-Peak Jitter ⁽¹⁾	--	10	pS	(No SS and PLL disabled)
LVC MOS Output Parameters for $V_{DDOUT} = 1.8V$				
Output High, $V_{DDOUT} = 1.8V$	1.6	--	V	$I_{OH} = -0.1$ mA
	1.4	--	V	$I_{OH} = -3.0$ mA
	1.1	--	V	$I_{OH} = -6.0$ mA
Output Low, $V_{DDOUT} = 1.8V$	--	0.1	V	$I_{OH} = +0.1$ mA
	--	0.3	V	$I_{OH} = +3.0$ mA
	--	0.6	V	$I_{OH} = +6.0$ mA
Rise & Fall Time	--	0.9	nS	$V_{DDOUT} = 1.8V$, 20 - 80%, 10pF Load
Output Symmetry	45	55	%	at 50% point of V_{DDOUT}
I_{DD} (no PLL enabled)	--	2.5	mA	
I_{DD} (PLL enabled)	--	9	mA	SS option or 15ppm or 10 ppm stability
I_{DDOUT}	--	2.5	uA	10pF Load
Peak-to-Peak Jitter ⁽¹⁾	--	10	pS	(No SS and PLL disabled)
LVC MOS Output Parameters for $V_{DDOUT} = 1.8V$ "L" Version				
Output High, $V_{DDOUT} = 1.8V$	1.6	--	V	$I_{OH} = -0.1$ mA
	1.4	--	V	$I_{OH} = -4.0$ mA
	1.1	--	V	$I_{OH} = -8.0$ mA
Output Low, $V_{DDOUT} = 1.8V$	--	0.1	V	$I_{OH} = +0.1$ mA
	--	0.3	V	$I_{OH} = +4.0$ mA
	--	0.6	V	$I_{OH} = +8.0$ mA
Rise & Fall Time		0.7	nS	$V_{DDOUT} = 1.8V$, 20 - 80%, 10pF Load

Item	Min	Max	Unit	Condition
Output Symmetry	45	55	%	at 50% point of V_{DDOUT}
I_{DD} (no PLL enabled)	--	2.5	mA	
I_{DD} (PLL enabled)	--	9	mA	SS option or 15ppm or 10 ppm stability
I_{DDOUT}	--	3	uA	10pF Load
Peak-to-Peak Jitter ⁽¹⁾	--	10	pS	(No SS and PLL disabled)
VCXO Function				
Vcontrol Input Range Usable	0.5	$V_{DD} - 0.5V$	V	The slope is positive
Vcontrol Input Range Allowed - Direct connect to Vcontrol - Limit current to $\pm 3mA$	0.0 -1.0	V_{DD} 4.0	V	The slope is positive Recommend $\geq 1K$ ohm to Vcontrol
Pull Ability specified in the P.N.	--	--		
Linearity	-10	+10	%	

(1) 10,000 cycles

Load Circuit and Test Waveform



Reliability: Environmental Compliance

Parameter	Condition
Mechanical Shock	MIL-STD-883 Method 2002, Condition B
Vibration	MIL-STD-883 Method 2007, Condition A
Solderability	MIL-STD-883 Method 2003
Thermal Shock	MIL-STD-883 Method 1011, Condition A

ESD Rating

Model	Minimum Voltage	Conditions
Human Body Model	1500	MIL-STD-883 Method 3115
Charged Device Model	1000	JESD 22-C101

Package Labeling

Label is 1" x 2.6" (25.4mm x 66.7mm)
Font is Courier New
Bar code is 39-Full ASCII
(Label will show FD51xxT-32.768K)

Label is 1" x 2.6" (25.4mm x 66.7mm)
Font is Arial

P/N:	
Customer P/N:	
Qty:	D/C

RoHS Compliant
2nd LVL Interconnect
Category=e4
Max Safe Temp=260C for 10s 2X Max

Mechanical:



Contacts:
Gold 11.8 μ mches 0.3 μ m minimum over
Nickel 50 to 350 μ mches 1.27 to 8.89 μ m

¹ Typical dimensions

Not to Scale

	Inches	mm
A	0.197 \pm 0.006	5.00 \pm 0.15
B	0.125 \pm 0.006	3.20 \pm 0.15
C	0.053 max	1.35 max
D ¹	0.050	1.27
E ¹	0.050	1.27
F ¹	0.004	0.10
G ¹	0.039	1.00
H ¹	0.025	0.63
I ¹	0.020	0.50
J ¹	0.004R	0.10R
K ¹	0.008R	0.20R

Pad Functions:

Pad	Function	Note
1	S1/SDA	Serial Data Clock (optional V control - VCXO)
2	S2/SCL	Serial Data
3	Ground (GND)	
4	Out (Y3)	Crystal reference frequency divided by 1 through 1023 PLL1 frequency divided by 1 through 1023
5	V _{DD}	1.8V, powers internal circuitry of the oscillator. Bypass capacitor required near the package pin.
6	V _{DDOUT}	1.8V, 2.5V or 3.3V supply for the output buffers. Sets CMOS output level. Bypass capacitor required near the package pin.

All unused inputs should be pulled high.

Reflow Cycle (typical for lead free-processing)

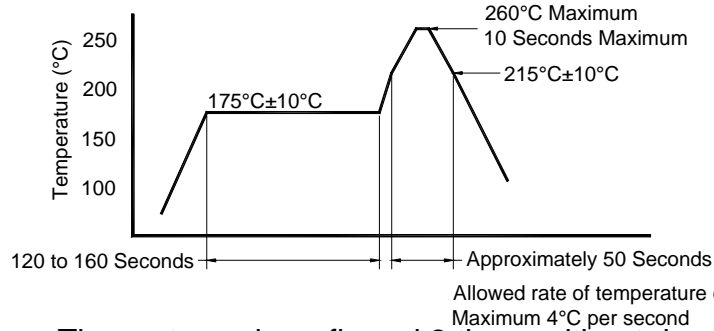

The part may be reflowed 2 times without degradation.

Tape and Reel: available for quantities of 250 to 1000 per reel, cut tape for < 250

Constant Dimensions Table 1								
Tape Size	D0	D1 Min	E1	P0	P2	S1 Min	T Max	T1 Max
8mm	1.5	1.0	1.75 ± 0.1	4.0 ± 0.1	2.0 ± 0.05	0.6	0.6	0.1
12mm		1.5			2.0 ± 0.1			
16mm		+0.1 -0.0			1.5			
24mm		1.5			1.5			

Variable Dimensions Table 2							
Tape Size	B1 Max	E2 Min	F	P1	T2 Max	W Max	Ao, Bo & Ko
16 mm	12.1	14.25	7.5 ± 0.1	8.0 ± 0.1	8.0	16.3	Note 1

Note 1: Embossed cavity to conform to EIA-481-B

Not to scale



		REEL DIMENSIONS			
A	inches	7.0	10.0	13.0	Tape Width
	mm	177.8	254.0	330.2	
B	inches	2.50	4.00	3.75	Tape Width
	mm	63.5	101.6	95.3	
C	mm	13.0 +0.5 / -0.2			Tape Width
D	mm	16.4 +2.0 -0.0	16.4 +2.0 -0.0	16.4 +2.0 -0.0	

USER DIRECTION OF UNREELING →

Reel dimensions may vary from the above

IMPORTANT NOTICE

Pletronics Incorporated (PLE) reserves the right to make corrections, improvements, modifications and other changes to this product at any time. PLE reserves the right to discontinue any product or service without notice. Customers are responsible for obtaining the latest relevant information before placing orders and should verify that such information is current and complete. All products are sold subject to PLE's terms and conditions of sale supplied at the time of order acknowledgment.

PLE warrants performance of this product to the specifications applicable at the time of sale in accordance with PLE's limited warranty. Testing and other quality control techniques are used to the extent PLE deems necessary to support this warranty. Except where mandated by specific contractual documents, testing of all parameters of each product is not necessarily performed.

PLE assumes no liability for application assistance or customer product design. Customers are responsible for their products and applications using PLE components. To minimize the risks associated with the customer products and applications, customers should provide adequate design and operating safeguards.

PLE products are not designed, intended, authorized or warranted to be suitable for use in life support applications, devices or systems or other critical applications that may involve potential risks of death, personal injury or severe property or environmental damage. Inclusion of PLE products in such applications is understood to be fully at the risk of the customer. Use of PLE products in such applications requires the written approval of an appropriate PLE officer. Questions concerning potential risk applications should be directed to PLE.

PLE does not warrant or represent that any license, either express or implied, is granted under any PLE patent right, copyright, artwork or other intellectual property right relating to any combination, machine or process which PLE product or services are used. Information published by PLE regarding third-party products or services does not constitute a license from PLE to use such products or services or a warranty or endorsement thereof. Use of such information may require a license from a third party under the patents or other intellectual property of the third party, or a license from PLE under the patents or other intellectual property of PLE.

Reproduction of information in PLE data sheets or web site is permissible only if the reproduction is without alteration and is accompanied by associated warranties, conditions, limitations and notices. Reproduction of this information with alteration is an unfair and deceptive business practice. PLE is not responsible or liable for such altered documents.

Resale of PLE products or services with statements different from or beyond the parameters stated by PLE for that product or service voids all express and implied warranties for the associated PLE product or service and is an unfair or deceptive business practice. PLE is not responsible for any such statements.

Contacting Pletronics Inc.

Pletronics Inc.
19013 36th Ave. West
Lynnwood, WA 98036-5761 USA

Tel: 425-776-1880
Fax: 425-776-2760
E-mail: ple-sales@pletronics.com
URL: www.pletronics.com

Copyright © 2009 Pletronics Inc.