

Coaxial Frequency Mixer

Level 17 (LO Power +17 dBm) 2 to 500 MHz

ZFM-1H+



SMA version shown
CASE STYLE: K18
Connectors Model
BNC ZFM-1H+
SMA ZFM-1H-S+
BRACKET (OPTION "B")

+RoHS Compliant
The +Suffix identifies RoHS Compliance. See our web site for RoHS Compliance methodologies and qualifications

Maximum Ratings

Operating Temperature	-55°C to 100°C
Storage Temperature	-55°C to 100°C
RF Power	200mW
IF Current	40mA

Permanent damage may occur if any of these limits are exceeded.

Coaxial Connections

LO	1
RF	2
IF	3

Features

- low conversion loss, 6.14 dB typ.
- good L-R isolation, 40 dB typ, L-I, 35 dB typ.
- rugged shielded case

Applications

- VHF/UHF
- defense & federal communications
- FM radio
- instrumentation

Outline Drawing

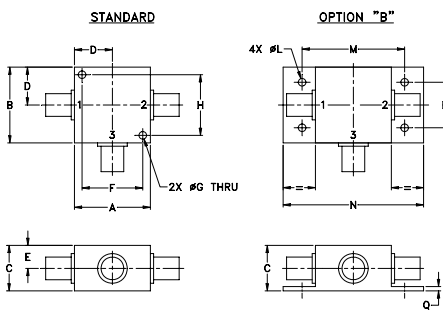

Outline Dimensions (inch/mm)

A	B	C	D	E	F	G	H
1.25	1.25	.75	.63	.38	1.00	.125	1.000
31.75	31.75	19.05	16.00	9.65	25.40	3.18	25.40

J	K	L	M	N	P	Q	wt
--	--	.125	1.688	2.18	.75	.07	grams
--	--	3.18	42.88	55.37	19.05	1.78	70.0

Electrical Specifications

FREQUENCY (MHz)		CONVERSION LOSS (dB)				LO-RF ISOLATION (dB)						LO-IF ISOLATION (dB)					
LO/RF	IF	Mid-Band		Total Range	Max.	L		M		U		L		M		U	
		\bar{X}	σ			Typ.	Min.	Typ.	Min.	Typ.	Min.	Typ.	Min.	Typ.	Min.	Typ.	Min.
2-500	DC-500	6.14	0.11	7.5	8.5	50	45	40	30	30	25	45	35	35	25	25	20

1 dB COMP.: +14 dBm typ. L = low range [f_L to $10 f_L$] M = mid range [$10 f_L$ to $f_U/2$] U = upper range [$f_U/2$ to f_U]
m = mid band [$2f_L$ to $f_U/2$]

Typical Performance Data

Frequency (MHz)		Conversion Loss (dB)	Isolation L-R (dB)	Isolation L-I (dB)	VSWR RF Port (:1)	VSWR LO Port (:1)
RF	LO	LO +17dBm	LO +17dBm	LO +17dBm	LO +17dBm	LO +17dBm
2.00	32.00	6.30	62.98	52.28	1.22	1.67
5.00	35.00	5.95	62.06	52.79	1.10	1.60
10.00	40.00	5.92	60.47	52.35	1.03	1.63
20.00	50.00	5.91	57.14	51.13	1.02	1.61
34.13	64.13	5.81	53.27	49.30	1.04	1.58
50.00	80.00	5.72	50.24	47.27	1.06	1.57
66.26	96.26	5.66	48.03	45.61	1.07	1.55
82.33	122.33	5.71	46.33	44.27	1.08	1.54
100.00	170.00	5.63	44.99	43.26	1.09	1.57
130.52	210.52	5.61	43.18	41.91	1.10	1.55
162.65	242.65	5.61	41.46	40.45	1.10	1.55
200.00	270.00	5.60	40.12	39.22	1.08	1.60
259.04	329.04	5.42	38.10	37.51	1.07	1.67
307.24	377.24	5.62	37.54	36.13	1.06	1.70
355.43	425.43	5.86	37.41	36.94	1.05	1.76
387.56	457.56	5.92	36.35	35.99	1.04	1.82
435.76	505.76	5.81	35.35	35.91	1.05	1.84
467.89	537.89	5.90	36.34	35.81	1.06	1.85
483.95	553.95	6.08	36.44	35.54	1.08	1.87
500.00	470.00	6.27	36.27	33.21	1.09	1.90

Electrical Schematic

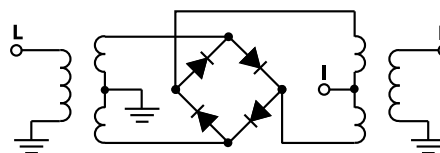

Notes

- Performance and quality attributes and conditions not expressly stated in this specification document are intended to be excluded and do not form a part of this specification document.
- Electrical specifications and performance data contained in this specification document are based on Mini-Circuit's applicable established test performance criteria and measurement instructions.
- The parts covered by this specification document are subject to Mini-Circuit's standard limited warranty and terms and conditions (collectively, "Standard Terms"); Purchasers of this part are entitled to the rights and benefits contained therein. For a full statement of the Standard Terms and the exclusive rights and remedies thereunder, please visit Mini-Circuit's website at www.minicircuits.com/MCLStore/terms.jsp



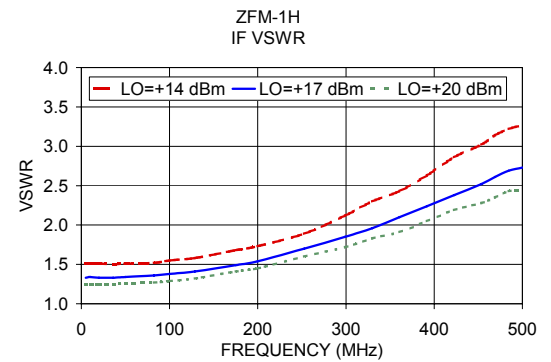
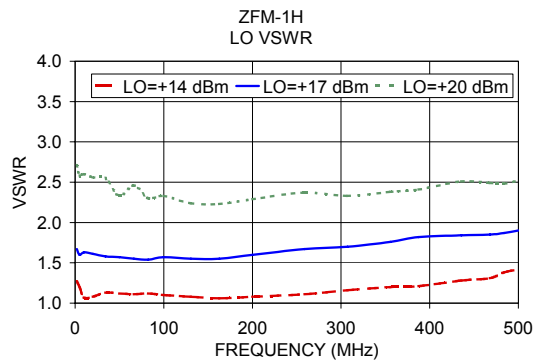
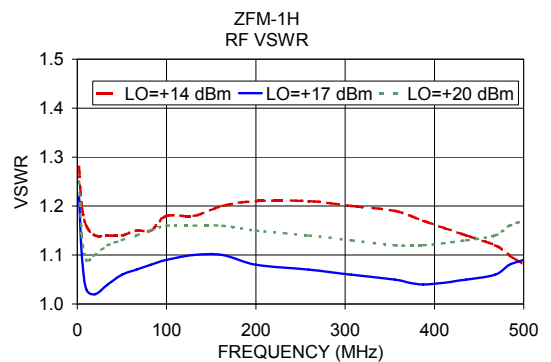
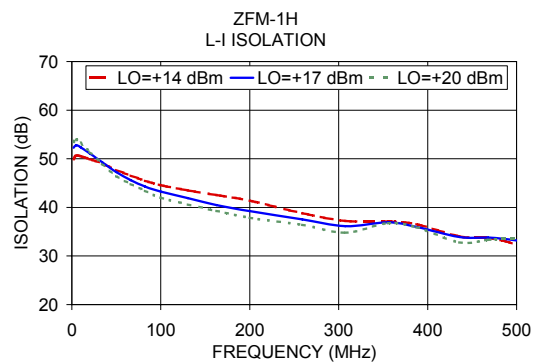
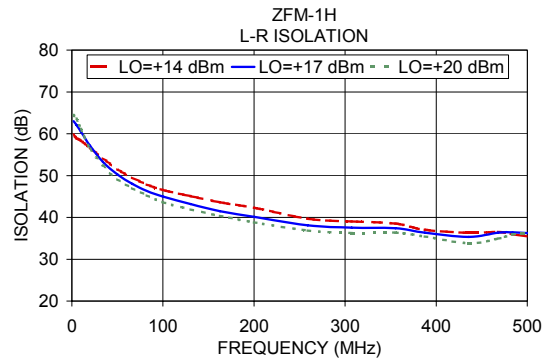
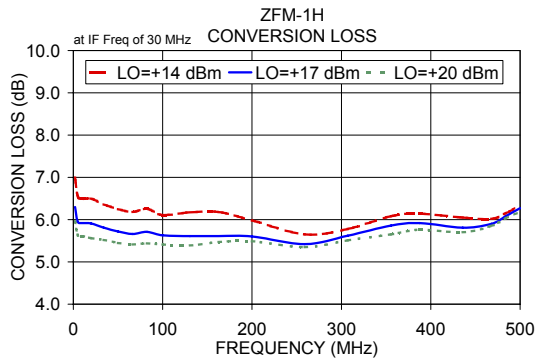

Notes

- A. Performance and quality attributes and conditions not expressly stated in this specification document are intended to be excluded and do not form a part of this specification document.
- B. Electrical specifications and performance data contained in this specification document are based on Mini-Circuit's applicable established test performance criteria and measurement instructions.
- C. The parts covered by this specification document are subject to Mini-Circuits standard limited warranty and terms and conditions (collectively, "Standard Terms"); Purchasers of this part are entitled to the rights and benefits contained therein. For a full statement of the Standard Terms and the exclusive rights and remedies thereunder, please visit Mini-Circuits' website at www.minicircuits.com/MCLStore/terms.jsp

